











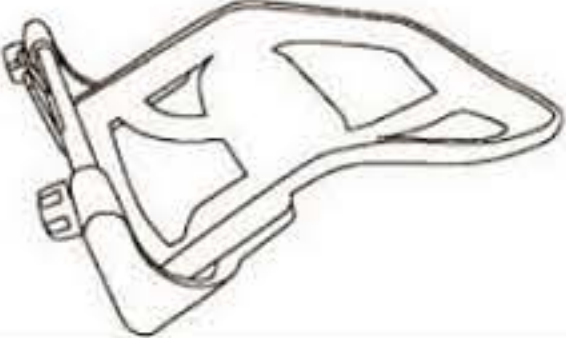

Assembly Instructions

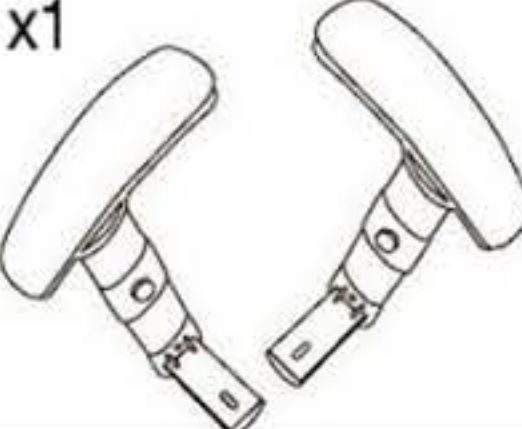
OA1013

<p>(A) x2</p> 	<p>(B) x7</p>  <p>8x20mm</p>	<p>(C) x7</p> 	<p>(D) x7</p> 	<p>(E) x1</p> 
<p>(F) x1</p> 	<p>(G) x1</p> 	<p>(H) x1</p> 	<p>(I) x1</p> 	<p>(J) x1</p> 
<p>(K) x1</p> 	<p>(L) x1</p> 	<p>(M) x5</p> 	<p>(N) x1</p> 	<p>(O) x1</p> 

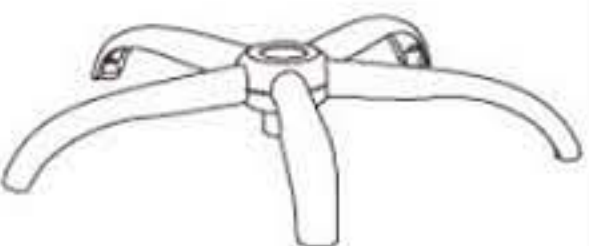

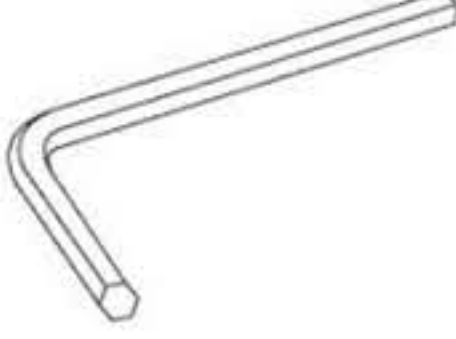
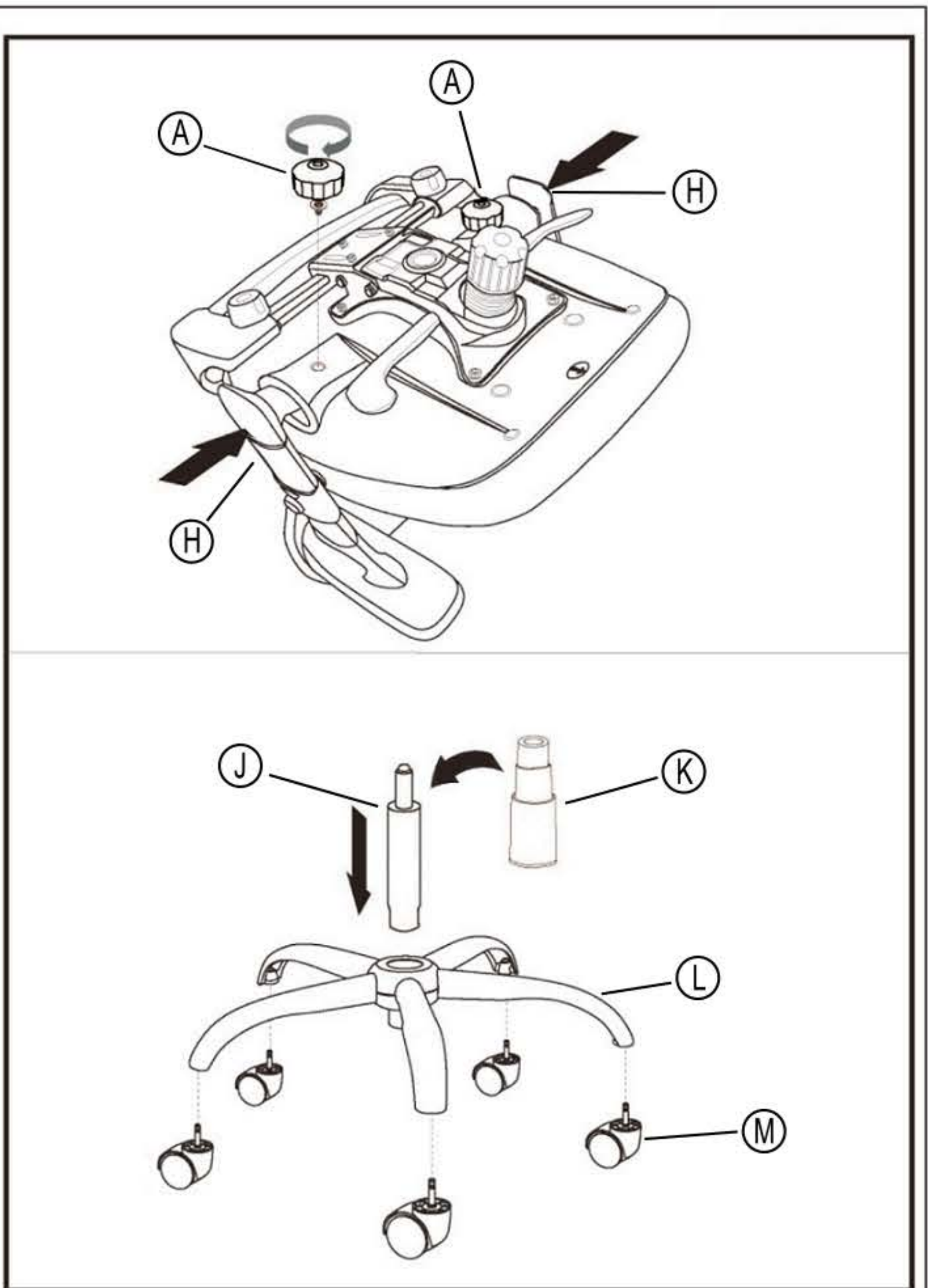
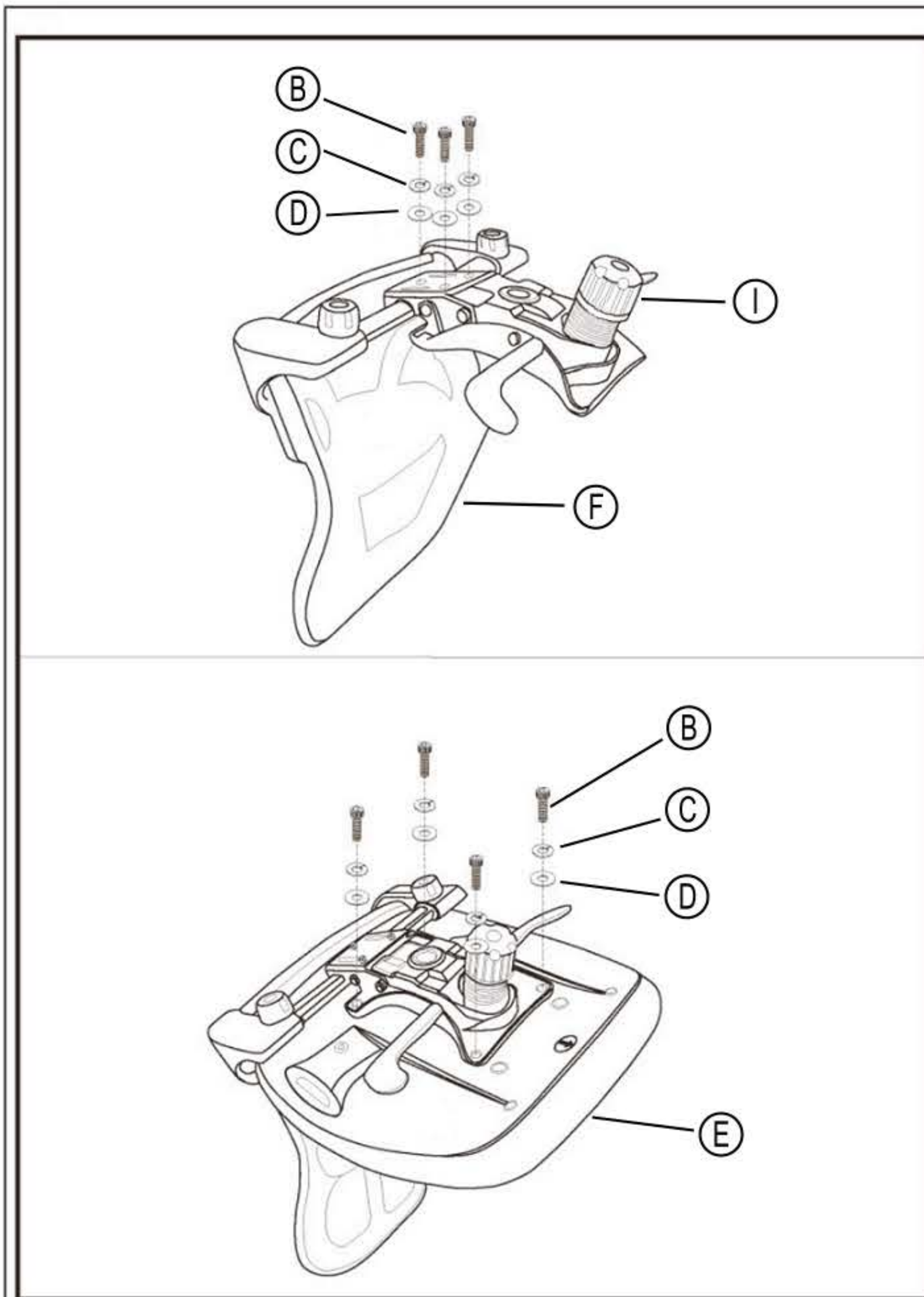
ASSEMBLY INSTRUCTIONS

OA1013

