

tc group

The Directory
2020

OUR PHILOSOPHY

Our philosophy is simple – people are important.

Whether it's the people using our products, the people selling them or the dedicated team working behind the scenes – people are at the heart of our company.

We're not your average business, and this is something that will never change; our customers and our team will forever remain the most important part of our business.

We care about you and your needs, which is why we work hard to source quality products for our customers across the UK and Europe. We also take a great deal of pride in our team, who help us to make it happen.

With a firm focus on service and support, we provide a variety of office seating, desking, storage, conference and training furniture. We also offer a selection of delivery services to match our customer's needs.



Personal performance drives business success. Our people maximise their performance through ongoing training in clear and positive thinking, allowing them to achieve their goals - and quickly.

The outcome? A successful business that is driven by high-achieving individuals who are positive, motivated and happy.



BCFA MEMBER



We belong to the BCFA (British Contract Furnishing & Design Association), the trade association for the British Contract Furnishing Industry. As members of the BCFA, we remain committed to achieving higher standards in both the design of our products and the services we offer.

ENVIRONMENTAL POLICY – BS-EN ISO14001:2015 CERTIFIED



We care about the environment, and to show this, we regularly evaluate our procedures and implement new strategies to reduce our ecological footprint. We measure, manage and control our environmental impact by being certified to ISO 14001:2015.

QUALITY MANAGEMENT – BS EN ISO 9001:2008 CERTIFIED



Our Quality Management system is compliant to BS EN ISO9001:2008. This accreditation ensures that all of our products, processes and systems are monitored and measured. They regularly go through management review ensuring compliance with the regulatory requirements of this International Quality Standard.

CONTENTS

// 00 INTRO

03	Our Philosophy	08	Space Planning
04	Contents	09	Material Finishes
06	Delivery and Installation		

// 02 BENCH DESKING

18	Premium Bench Explanation	24	Single Bench
20	Premium Bench	26	Back to Back Bench
22	Fixed Beam Bench Explanation		

// 04 SCREENS

48	Divide Type 1 Screen - Single Toolrail	54	Lyle Desk Screens
		55	Toolrail Screens
49	Divide Type 2 Screen - Triple Toolrail	56	Panel Screens
		57	Screen Accessories
50	Mobile Screens	58	Screen Finish Guide
52	Contempo Screens	60	Mangnum Screens
53	Elco Screens		

// 06 STEEL STORAGE

72	Talos Steel Pedestals	76	Bisley Multidrawers	82	Office Plan Chests	92	Personal Effects Lockers
73	Talos Filing Cabinets	77	Bisley Essentials Side Filers	83	Office Lockers	93	High Capacity Storage Cupboards
74	Bisley Classic Filing	78	Talos Tambours	84	Fire Resistant Safes	94	Dangerous Substance Safety Cabinets
74	Bisley Contract Filing	79	Bisley Essentials Tambours	86	Safes	94	Dangerous Substance Safety Cabinets
75	Bisley A4 Personal Home Filing	80	Talos Cupboards	88	Standard Lockers	95	Low Height Lockers
75	Bisley A4 Home Filing	81	Bisley Contract Cupboards	90	Multi-purpose Lockers		
		81	Bisley Essentials Cupboards	91	All White Lockers		

// 07 PROJECT

98	Linnea Elevate - Height Adjustable	112	Linnea & Optima Pedestals & Filing
100	Linnea Elevate - Fixed Height	114	Linnea & Optima Bookcases
102	Linnea Bench	115	Linnea & Optima Cupboards
106	Linnea Accessories	116	Optima Tambours
108	Optima Plus Height Adjustable Desks	117	Storage Units
110	Optima Plus	118	Optima Plus Meeting Tables
		120	Optima Plus Conference Tables

// 09 MEETING TABLES

134	Plateau	142	Windsor	148	Union Folding Tables	155	Summit
136	Plateau High	143	Aerofoil	150	One Tables	156	Start 18 Multipurpose
138	Meeting Tables	144	Fraction Infinity Tables	151	Contract Blocks	158	Contract Tables
140	Reflex	146	Tilting Tables	152	Picnic	160	Coffee Tables
141	Lux	147	Economy Tilting Tables	154	Modular Tables		

// 10 RECEPTION

164	Invite Reception
168	Modular Reception
170	Reception

// 01 HEIGHT ADJUSTABLE

12	Height Adjustable Bench	15	Height Adjustable Desk
14	Economy Height Adjustable Desk		

// 03 DESKING

30	Cable Managed Leg	38	Twin Upright Leg
32	Goalpost Leg	40	Single Upright Leg
34	Panel Plus	42	Eco 18
36	Panel	44	Desk Accessories

// 05 WOODEN STORAGE

64	Wooden Pedestals	69	Eco 18 Bookcases & Cupboards
65	Wooden Filing		
66	Wooden Bookcases		
67	Wooden Cupboards		
68	Panel Plus Cupboards		
69	Eco 18 Premium Bookcases & Cupboards		

// 08 EXECUTIVE DESKING

124	E-Space
128	Regent
130	Regent Bookcases & Cupboards

// 11 SEATING FAMILIES

172	Things To Consider	182	Denali
173	Mechanism Guide	184	Air Task
176	Rome	186	Milan
180	Vogue		

// 12 TASK CHAIRS

192	Willow	200	Fonseca 2
193	Ash	201	Marlos
194	Kind	201	Carbon
196	Kind Mesh	202	Spark
198	Maldini	202	Vida
199	Zico	203	Air Task
199	Scuba	203	Start Mesh
200	Kempes		

// 14 EXECUTIVE SEATING

221	Pallas	229	Ares
221	Zeus	229	Casino II
222	Cronos	230	Canasta II
222	Montana	231	Jack II
223	Whist		
224	Milan		
225	Flex		
226	Sosa		
227	Puma		
227	Baresi		
228	Keno		

// 16 OPERATOR SEATING

264	Topaz
268	Concept
270	Calypso
272	Typist
272	Zoom
274	Lapis Perch
274	Sway
276	Factory
278	Factory Fabric
280	Accessories

// 18 SOFT SEATING

314	Cascara	332	Intro Modular Seating	357	Moonstone	368	Pearl
316	Me, Myself & I	336	Evo Plus Modular Seating	358	Face	369	Ruby
318	Wave Swivel Chair	340	Evo Plus Medium Back	360	Tandem	370	Juplo
320	Spirit Lite	344	Fifteen Diner	362	Tub	372	Glacier
322	Spirit Rocking	350	Fence	364	Tub Lux	373	Rubic
324	Phonic	354	Tux	366	Children's Tub Chairs		
330	Button	356	Iceberg	368	Jade		

// 19 EDUCATION

376	Nurture	396	T-Bag
378	Uni	398	Link
380	Study	400	KD Classroom Tables
382	Titan One Piece	402	Exam Desks & Folding Tables
384	Titan 4-Leg	404	IT Classroom Chairs
386	Titan Skid	406	Lab Chairs
388	Titan Teach & Move	408	Teacher Furniture
390	Titan High Chair	410	Staffroom
392	Titan Stool	411	Dining Hall Tables
394	Titan Swivel	412	Titan Accessories

// 13 24HR & HEAVY DUTY

206	Strata	214	Call Centre
207	Fonz	215	Caracal
208	Alto	216	Maxi Ergo
209	Chachi	217	Calypso Ergo
210	Cheetah		
211	Panther		
212	Vista		
213	Marathon		

// 15 MEETING & CONFERENCE

234	Ares	253	Renoir
234	Canasta II	254	Jupiter
235	Pavia	256	Rome Skid
235	Lazio	257	Twilight
236	Key	258	Economy Poly
240	Milan	258	Summit Sienna
242	Florence	258	Summit Meeting
246	Kind	259	Summit Banquet
248	Pimlico	259	Cube
250	Arena	260	Club
252	Pavillion		

// 17 CAFE & DINING

284	Adapt	297	Milano
286	Ariel	298	Picasso
288	Chester	300	Picasso Lite
290	Fjord	300	Ellipse
291	Benny	302	Picnic
292	Bjorn	304	Stork
294	Lunar	304	Astral High
295	Sena	306	Plaza
296	Orlando	308	Morph
296	Forza	310	Folding Chair
297	Ramiro	310	Folding Chair Trolley

// 20 FABRIC & FINISHES

414	Fabric Band Guide
416	Fabrics
420	Finishes & Colours
423	Terms & Conditions

DELIVERY AND INSTALLATION

We are committed to giving our customers an exceptional experience. Our D&I service allows you to sit back and relax, while we efficiently deliver and install your furniture - you are the centre of this process.



With our experienced fitters overseeing the whole process from beginning to end, there's nobody who can install our furniture better than us. Once you have placed your order, we will deliver and fit within 10-15 working days. We guarantee you the install will be stress-free by implementing the following practices:

1. Staff will observe good housekeeping and safety policies at all times
2. Once you are happy, all packaging is disposed of correctly and recycled where possible
3. A member of our experienced D&I team will then offer you a complimentary product demonstration, to ensure you are confident and happy with your new products

It's better for everyone when things go smoothly. Please ensure that:

- You have considered the 3 Ps; the **postcode** of the delivery and install location, what **products** it is that you require and any **problems** we may run into with the install, for example, no lift or restricted access
- You carefully consider any special security requirements
- You provide on-site contact details, as you will receive a delivery date and time slot via text or email. The driver will also call on the day



DELIVERY SERVICES

We have several delivery services available, all tailored to you and your requirements.

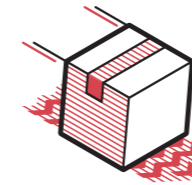

NEXT DAY DELIVERY

Need something tomorrow? Place your order with us, and we will ensure it reaches you by the next working day. No matter the order size, we can get you what you need, when you need it. It's that simple.



5 - 7 DAY DELIVERY

Not in a rush? Delivery for all stocked products will be on our 5-7 day service.



ROOM OF CHOICE

If you need some additional assistance, but not full delivery and installation, our Room of Choice option is the service for you. We offer a two-man delivery, to the room the products are being used. We take out all the heavy lifting and transporting of goods, leaving everything exactly how you want it.



NOMINATED DAY

Our priority is always making life that little bit easier for all our customers. Our Nominated Day delivery service is tailored to fit around you. You choose the day and time slot; we'll do the rest.

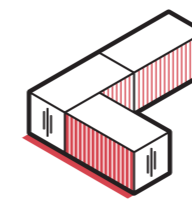

CONTAINERISED DELIVERIES

Your high volume products never need to go out of stock again with our containerised delivery option. Order a full container of products and enjoy a significant cost saving. We receive and monitor your order, and keep you fully informed until it reaches your door. It's that easy.

If you need any more information about any of the services outlined below, please contact our Sales Team, and we will be delighted to assist you.

SPACE PLANNING

Correct planning ensures you are getting the most out of your space. We offer a space planning service which utilises the maximum capacity of your workspace safely and efficiently.

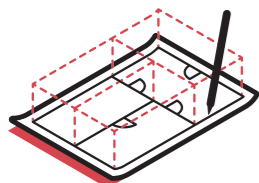

Our experienced team use the latest software to ensure a full planning service, from site surveys and 2D plans to walk-through 3D visualisations. Just give us your measurements, and we will create and suggest possible layouts to enhance your existing office space.

2D PLANS

Our 2D plans turn your measurements into a well thought out working area to suit your particular requirements. Once your furniture plan is complete, we can be as detailed as you need and display network points, lighting, heating, power, and anything else you may require. Want to hang on to a few things? Our 2D plans can show a mix of old and new furniture designed by our experienced team.

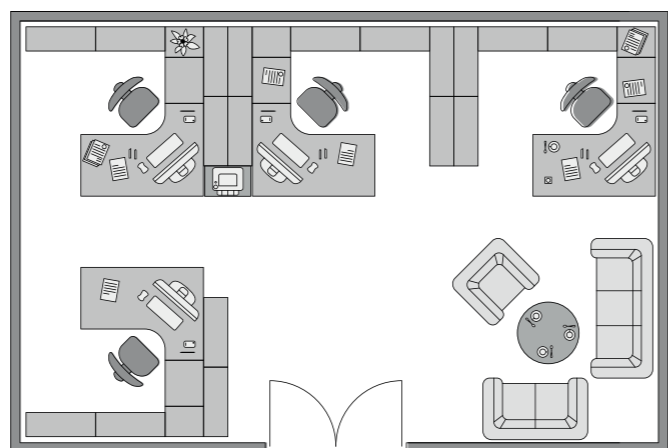

3D PLANS

We can take the 2D plan drawings a stage further by adding carpet and wall finishes, together with colour ideas to suit your corporate identity - or build on your ideas. Once created, we can produce a 3D walk-through visualisation, which enables you to see the result in a clear, concise way.

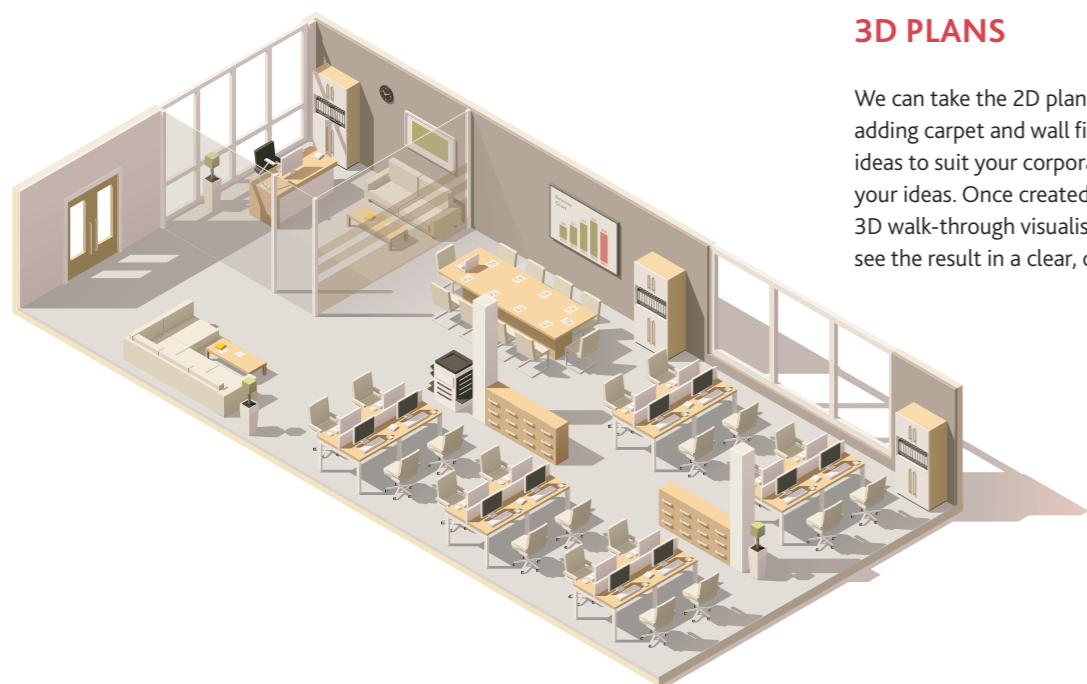

MATERIAL FINISHES

We are proud to work with a dedicated selection of the UK and Europe's longest established and best-recognised upholstery fabric, vinyl and leather manufacturers.

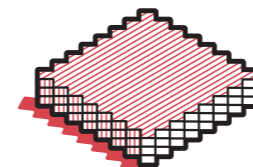

The fabrics we offer are a selection of the most popular within the market and are suitable for applications ranging from operator/task seating, soft seating and for the upholstery of vertical surfaces, such as desk mounted and floor standing screens.

Where environmental credentials are a significant consideration we are also able to source and recommend from a wide choice of ecological fabrics, made from recycled raw materials, or materials composed of rapidly renewable sources such as wool or innovative bast fibres from nettles, hemp or even recycled coffee sacks.

The range of manufacturers, finishes and price bands offers a solution for all specifications and budgets - please contact us for further details or assistance.

UNLIMITED FABRICS



Where you see the above icon, the product is available upholstered to your exact specification. Choose from multiple on-trend finishes to match your market place or corporate colour scheme, or if you're looking for something different to brighten up your business environment.

FIRE RETARDENCY

The fire retardancy or CRIB rating of a particular fabric measures its ability to resist ignition from an exposed flame. There are a variety of tests for the flammability of upholstery fabrics within the UK - we have listed a brief description of those applicable to our market below (please note this is not exhaustive; if further information is required, please contact us).

Low Hazard - tested to BS7176:2007 Low Hazard fabric ratings are suitable for use within the general office environment.

CRIB 5 - This indicates a fabric has been treated and tested and is suitable for most purposes, particularly contract environments like hotels, where the impact of a fire can especially be dangerous due to the volume of people.

CRIB 7 - This is a more stringent test version of CRIB 5. Fabric that passes this test is suitable for more hazardous environments like prisons or offshore installations.

PLEASE NOTE:

Fabric Bandings - Should your fabric of choice not be listed please contact our Sales Team who will be happy to assist. Please ensure you check the suitability of your selected fabric for its application before ordering.

Leather - Priced upon application.

Fabric Swatches - We recommend that your final fabric selection is made based on a physical swatch only; we recommend you use printed swatches merely as a guide.

All of the materials used within our furniture, seating and storage ranges are carefully selected and specified per our ISO 9001 certification. We work with globally renowned manufacturers to ensure we can bring to market quality products that stand the test of time and offer an exceptional value proposition. Our desktops and wooden storage are FSC certified MFC - Melamine Faced Chipboard.

We have a standard colour palette of six MFC wood finishes spanning our core range of desking and storage, comprising panel end, cantilever and bench solutions specified at 25mm for all desktops. Similarly, our Regent Executive range offers two dedicated MFC wood finishes at 36mm to give a unique executive edge. Our MFC supply chain is fully FSC (Forest Stewardship Council) certified and therefore accredited to ISO 14001 and ISO 9001.

HEIGHT ADJUSTABLE

// 01

On the move, can't sit still, are you the modern mobile worker? If the answer to all the above is yes- don't worry, we've got just the thing. Our range of height adjustable desks is designed so that you can stretch your legs and increase your productivity while also carefully considering health and cleverly utilising multifunctionality.

CONTENTS

- 12 Height Adjustable Bench
- 14 Economy Height Adjustable Desk
- 15 Height Adjustable Desk

HEIGHT ADJUSTABLE BENCH

5 YR
COMPONENT
GUARANTEE

25 MM
TOP
THICKNESS

MADE
TO
ORDER
30 DAYS



2 PERSON

	Dimensions			RRP
	W	D	H	
PRBS1280/2P	1200	1600	650 - 1300	£1918.00
PRBS1480/2P	1400	1600	650 - 1300	£1941.00
PRBS1680/2P	1600	1600	650 - 1300	£1961.00

4 PERSON

	Dimensions			RRP
	W	D	H	
PRBS1280/4P	2400	1600	650 - 1300	£3854.00
PRBS1480/4P	2800	1600	650 - 1300	£3900.00
PRBS1680/4P	3200	1600	650 - 1300	£3942.00

2 PERSON EXTENSION

	Dimensions			RRP
	W	D	H	
PRBS1280/2PX	1200	1600	650 - 1300	£1918.00
PRBS1480/2PX	1400	1600	650 - 1300	£1941.00
PRBS1680/2PX	1600	1600	650 - 1300	£1961.00

SCREENS

	Dimensions			RRP
	W	D	H	
PRBSEC1263	1000	25	628	£252.00
PRBSEC1463	1200	25	628	£277.00
PRBSEC1663	1400	25	628	£302.00

TOP FINISHES // FRAME FINISH

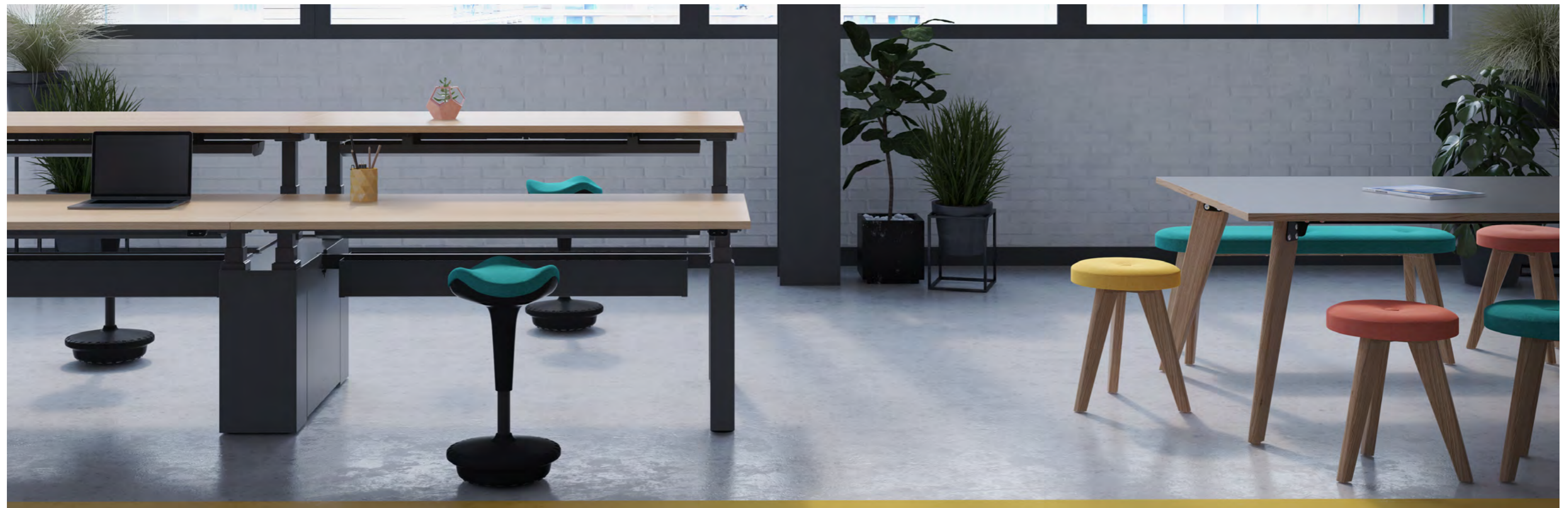
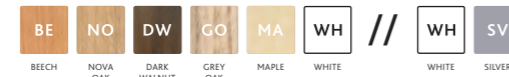

5^{YR}
COMPONENT
GUARANTEE

25^{MM}
TOP
THICKNESS

ECONOMY HEIGHT ADJUSTABLE DESK



- The economy height adjustable desk boasts an attractive, clean style with economy in mind
- Standing desks increase blood flow and improve overall health
- Preset your four optimum working heights using the built-in memory and digital display
- Twin motor
- Anti-collision
- Adjustable feet
- Featuring an adjustment range of 650-1290mm in height

RECTANGULAR DESK

	Dimensions			RRP
	W	D	H	
ECSS1280CP	1200	800	630 - 1290	£830.00
ECSS1480CP	1400	800	630 - 1290	£855.00
ECSS1680CP	1600	800	630 - 1290	£880.00

TOP FINISHES // FRAME FINISH



5^{YR}
COMPONENT
GUARANTEE

25^{MM}
TOP
THICKNESS

HEIGHT ADJUSTABLE DESK



- Height-adjustable UK made desk, perfect for converting from a traditional to a standing desk during your working day
- Standing desks increase blood flow and improves overall health
- Effortless adjustment which moves 28mm per second
- Easy to operate and use
- Heat and stain resistant 25mm top and sturdy metal frame
- Adjustable feet
- Featuring an adjustment range of 650 - 1300mm in height

RECTANGULAR DESK

	Dimensions			RRP
	W	D	H	
EDKD1280CP	1200	800	650 - 1300	£1161.00
EDKD1480CP	1400	800	650 - 1300	£1227.00
EDKD1680CP	1600	800	650 - 1300	£1287.00

TOP FINISHES // FRAME FINISH



BENCH DESKING

// 02

Bench desking doesn't always have to mean lots of people packed into one cramped space. The idea behind workbenches is to drive collaboration, optimise space and allow room for flexibility.

CONTENTS

- 18 Premium Bench Explanation
- 20 Premium Bench
- 22 Fixed Beam Bench Explanation
- 24 Single Bench
- 26 Back to Back Bench



PREMIUM BENCH EXPLANATION

The Premium Bench platform is a speedy and straightforward Bench system with an edge. By using a telescopic beam, it allows the system to be fully flexible by allowing the scope to construct lots of different layouts and configurations. Change needn't mean unnecessary cost.

In addition to its sliding telescopic beam, sliding top bridges **1** can replace its existing fixed ones, and an additional large capacity cable tray **2** is available to add. Both of these extra accessories further enhance this bench systems ability to facilitate various layouts by allowing easy access to cables for alteration and hide them out of the way.

Screens

A variety of screen brackets are available dependent on the type and design of screen required.

Mass cable risers **3** are available to add to the intermediate legs to enable running cables up from the floor by a simple magnetic fixing method.

Cable tray

Fitted to the underside of the desktop allowing it to hinge down from either side for easy access. Includes zip tie cable points and cable holes

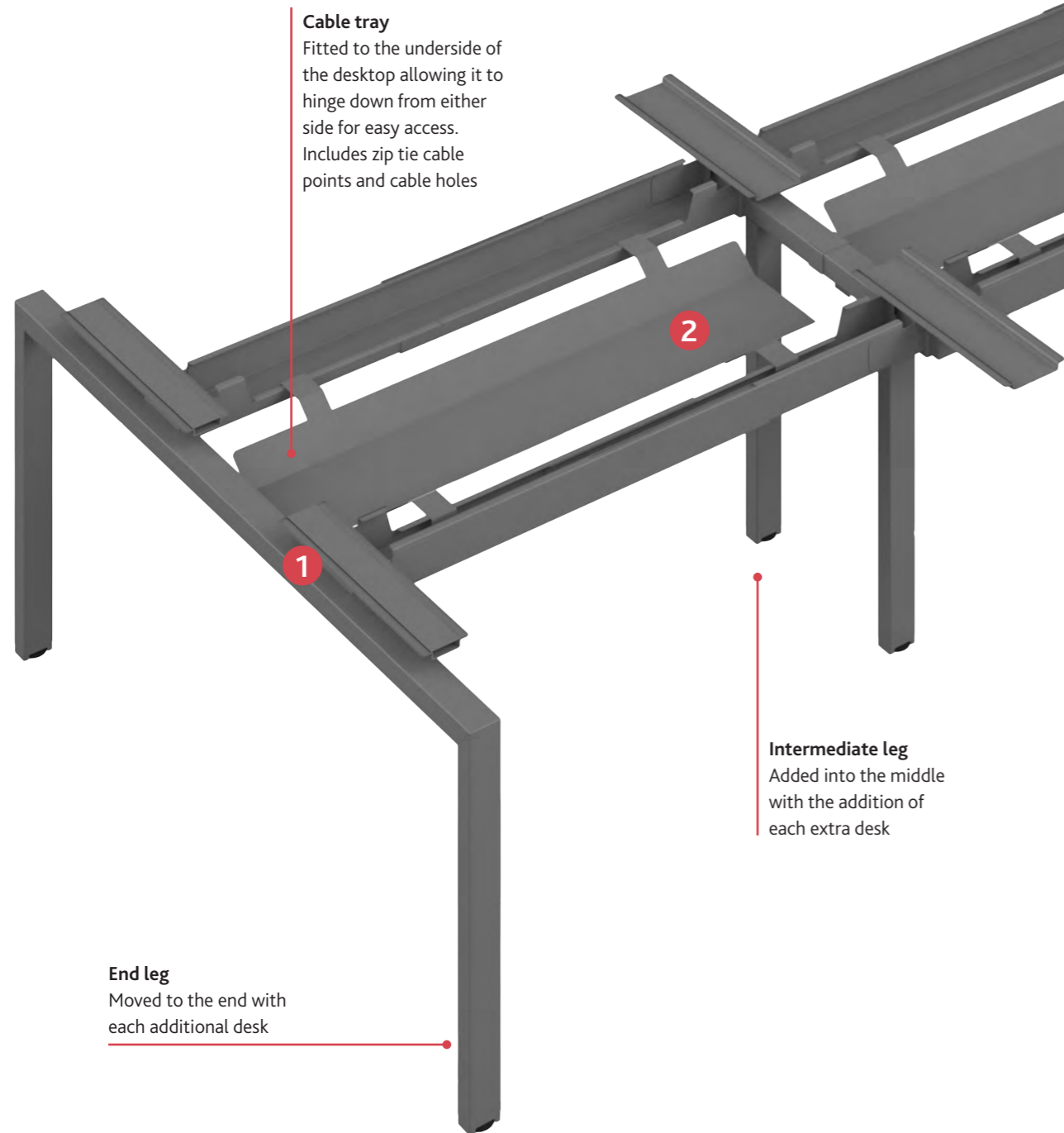

End leg

Moved to the end with each additional desk

Intermediate leg

Added into the middle with the addition of each extra desk

Screens

Metal to metal connection allowing rigid connection for unrivaled strength

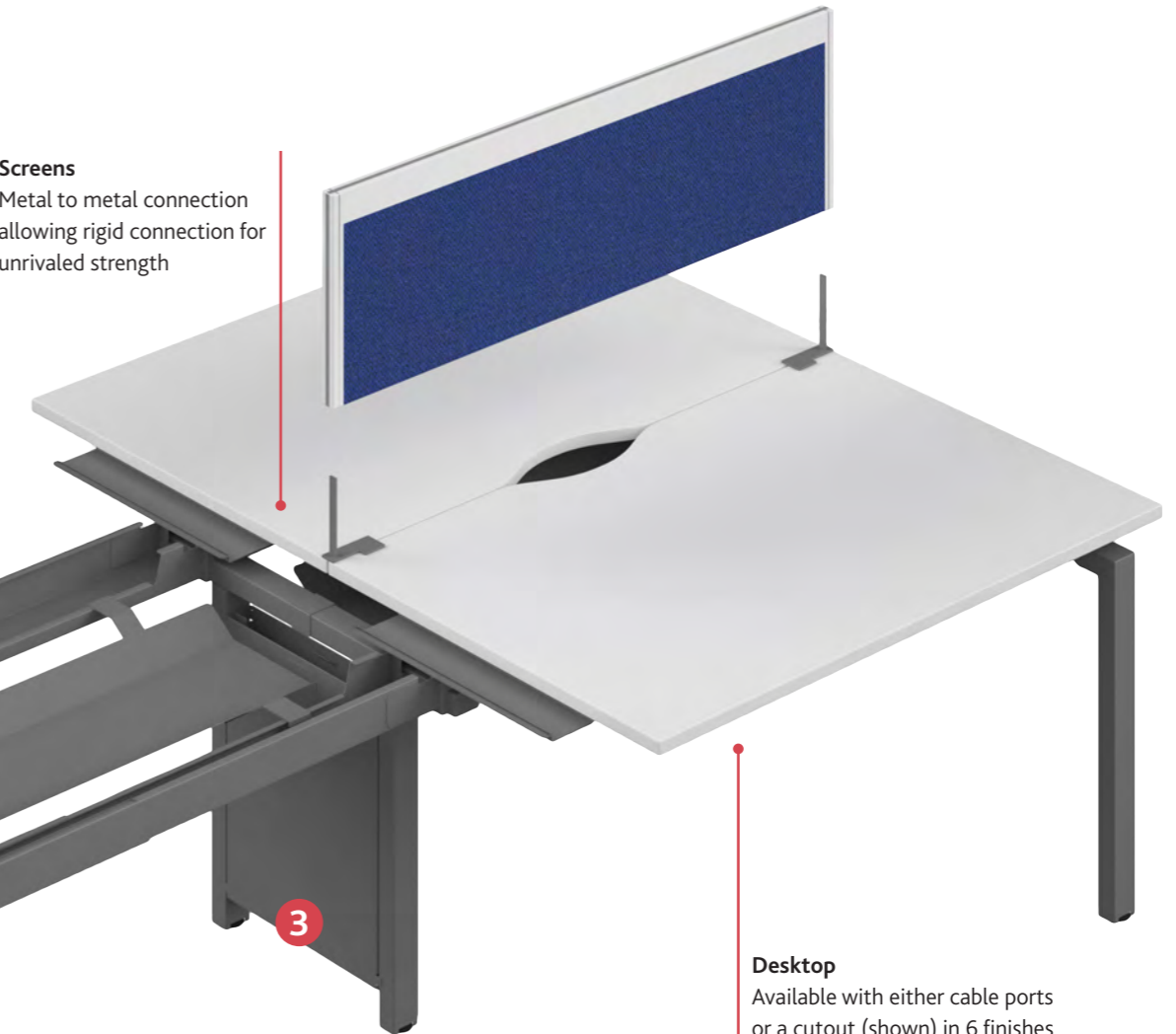

Desktop

Available with either cable ports or a cutout (shown) in 6 finishes and 3 widths

Top bracket

Gives the appearance of floating tops

STEP 1

Slot adjustable beams into the end legs; noting orientation and ensuring full engagement. Adjust beams to be the correct length for the desktop being used (1200 – 1800mm). The length of the beams can be secured into place using an M4 x 15mm bolt.

Slot adjustable beams into the intermediate leg or end leg (depending upon starter or extension); ensure full engagement prior to next step.

Secure cross rails to the intermediate leg using a steel top hat and secure using 4 x M6 x 15mm connector bolts.

Secure cross rails to the end leg using a steel top hat and secure using 2 x M6 x 15mm connector bolts.

Locate desktops and secure in place using the M6 x 20mm connector bolts.

STEP 2

Attach hanging brackets to the cable tray (optional accessory). The brackets simply hook onto the adjustable beam, which gives greater flexibility for any IT department.

To fit the cable riser, bolt the hook to the underside of the intermediate leg and then hook the side panel in place. Cables are then fed into position, and hook in the opposing panel to enclose the leg.

STEP 3

Attach screen brackets directly to the desktops using the bolts to secure these. Then simply slot the screens into place.

Tool rail and panel screens can be linked in-line with the integrated link strips supplied within each screen. Simply remove the upper or lower caps, discard one of the strips and use the remaining link strip by fitting on the centre line of the two screens, thus creating the link. To finish, re-fit the caps in place.

PREMIUM BENCH

5^{YR}
COMPONENT
GUARANTEE

25^{MM}
TOP
THICKNESS



1 PERSON STARTER

Cut-out Option	Cable Port Option	Dimensions			RRP
		W	D	H	
PRB1280CO/1P	PRB1280CP/1P	1200	800	720	£361.00
PRB1480CO/1P	PRB1480CP/1P	1400	800	720	£382.00
PRB1680CO/1P	PRB1680CP/1P	1600	800	720	£402.00

1 PERSON EXTENSION

Cut-out Option	Cable Port Option	Dimensions			RRP
		W	D	H	
PRB1280CO/1PX	PRB1280CP/1PX	1200	800	720	£341.00
PRB1480CO/1PX	PRB1480CP/1PX	1400	800	720	£361.00
PRB1680CO/1PX	PRB1680CP/1PX	1600	800	720	£382.00

2 PERSON STARTER

Cut-out Option	Cable Port Option	Dimensions			RRP
		W	D	H	
PRB1280CO/2P	PRB1280CP/2P	1200	1600	720	£611.00
PRB1480CO/2P	PRB1480CP/2P	1400	1600	720	£632.00
PRB1680CO/2P	PRB1680CP/2P	1600	1600	720	£652.00

2 PERSON EXTENSION

Cut-out Option	Cable Port Option	Dimensions			RRP
		W	D	H	
PRB1280CO/2PX	PRB1280CP/2PX	1200	1600	720	£516.00
PRB1480CO/2PX	PRB1480CP/2PX	1400	1600	720	£536.00
PRB1680CO/2PX	PRB1680CP/2PX	1600	1600	720	£557.00

TOP FINISHES // FRAME FINISH



- Features a telescopic beam that allows the system to be flexible by allowing the scope to construct different configurations; this is ideal for saving costs in an evolving office



FIXED BEAM BENCH EXPLANATION

Bench is a speedy and straightforward system to assemble, using a minimum number of tools. Bench uses laser-cut rails and end legs to allow interference fit 'splicing' of the two parts together, offering unrivalled strength and lateral stability. Fitting of the tops is the final part of this connection, effectively laminating the entire structure together.

Clever 'hinge down' cable trays can be added by merely bolting the cable tray brackets to the tops. Mass cable risers are available to add to the intermediate legs to enable running cables up from the floor by simply bolting in the hook and clipping in place.

Lastly, screens are fitted using 'metal-to-metal' connection by bolting the screen brackets to the legs and then sliding the screens onto the bracket. This connection then offers rigid screen fixing for the ability to mount monitor arms or other accessories as required. For more detail, please see the three simple steps below:

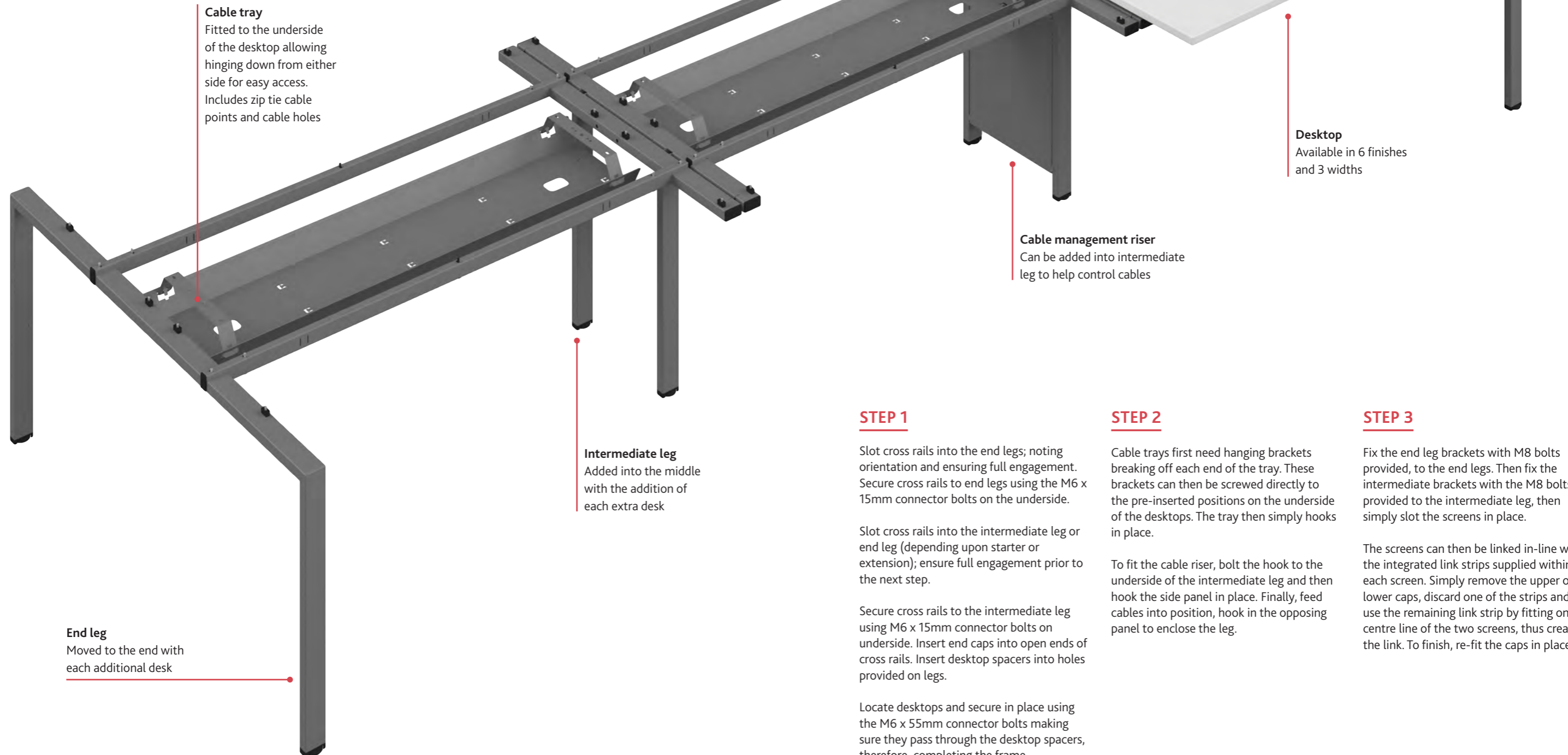

Cable tray
Fitted to the underside of the desktop allowing hinging down from either side for easy access. Includes zip tie cable points and cable holes

End leg
Moved to the end with each additional desk

Intermediate leg
Added into the middle with the addition of each extra desk

Cable management riser
Can be added into intermediate leg to help control cables

Desktop
Available in 6 finishes and 3 widths

Screens
Metal to metal connection allowing rigid connection for unrivalled strength

STEP 1

Slot cross rails into the end legs; noting orientation and ensuring full engagement. Secure cross rails to end legs using the M6 x 15mm connector bolts on the underside.

Slot cross rails into the intermediate leg or end leg (depending upon starter or extension); ensure full engagement prior to the next step.

Secure cross rails to the intermediate leg using M6 x 15mm connector bolts on underside. Insert end caps into open ends of cross rails. Insert desktop spacers into holes provided on legs.

Locate desktops and secure in place using the M6 x 55mm connector bolts making sure they pass through the desktop spacers, therefore, completing the frame.

STEP 2

Cable trays first need hanging brackets breaking off each end of the tray. These brackets can then be screwed directly to the pre-inserted positions on the underside of the desktops. The tray then simply hooks in place.

To fit the cable riser, bolt the hook to the underside of the intermediate leg and then hook the side panel in place. Finally, feed cables into position, hook in the opposing panel to enclose the leg.

STEP 3

Fix the end leg brackets with M8 bolts provided, to the end legs. Then fix the intermediate brackets with the M8 bolts provided to the intermediate leg, then simply slot the screens in place.

The screens can then be linked in-line with the integrated link strips supplied within each screen. Simply remove the upper or lower caps, discard one of the strips and use the remaining link strip by fitting on the centre line of the two screens, thus creating the link. To finish, re-fit the caps in place.

SINGLE BENCH

5^{YR}
COMPONENT
GUARANTEE

25^{MM}
TOP
THICKNESS



1 PERSON

Cut-out Option	Cable Port Option	Dimensions			RRP
		W	D	H	
CB1280CO/1P	CB1280CP/1P	1200	800	740	£330.00
CB1480CO/1P	CB1480CP/1P	1400	800	740	£357.00
CB1680CO/1P	CB1680CP/1P	1600	800	740	£371.00

2 PERSON

Cut-out Option	Cable Port Option	Dimensions			RRP
		W	D	H	
CB1280CO/2SP	CB1280CP/2SP	2400	800	740	£560.00
CB1480CO/2SP	CB1480CP/2SP	2800	800	740	£620.00
CB1680CO/2SP	CB1680CP/2SP	3200	800	740	£650.00

SINGLE EXTENSION

Cut-out Option	Cable Port Option	Dimensions			RRP
		W	D	H	
CB1280CO/1PX	CB1280CP/1PX	1200	800	740	£310.00
CB1480CO/1PX	CB1480CP/1PX	1400	800	740	£342.00
CB1680CO/1PX	CB1680CP/1PX	1600	800	740	£356.00

RETURN

Cut-out Option	Cable Port Option	Dimensions			RRP
		W	D	H	
CB6080/1RT		600	800	740	£243.00
CB6010/1RT		600	1000	740	£254.00

TOP FINISHES // FRAME FINISH



- Modular bench desking range, ideal for modern offices with scope to expand
- Horizontal and vertical cable management options available



BACK TO BACK BENCH

5 YR
COMPONENT
GUARANTEE

25 MM
TOP
THICKNESS



2 PERSON

Cut-out Option	Cable Port Option	Dimensions			RRP
		W	D	H	
CB1280CO/2P	CB1280CP/2P	1200	1600	740	£549.00
CB1480CO/2P	CB1480CP/2P	1400	1600	740	£603.00
CB1680CO/2P	CB1680CP/2P	1600	1600	740	£631.00

4 PERSON

Cut-out Option	Cable Port Option	Dimensions			RRP
		W	D	H	
CB1280CO/4P	CB1280CP/4P	2400	1600	740	£898.00
CB1480CO/4P	CB1480CP/4P	2800	1600	740	£1008.00
CB1680CO/4P	CB1680CP/4P	3200	1600	740	£1062.00

2 PERSON EXTENSION

Cut-out Option	Cable Port Option	Dimensions			RRP
		W	D	H	
CB1280CO/2PX	CB1280CP/2PX	1200	1600	740	£462.00
CB1480CO/2PX	CB1480CP/2PX	1400	1600	740	£505.00
CB1680CO/2PX	CB1680CP/2PX	1600	1600	740	£538.00

D-END

	Dimensions			RRP
	W	D	H	
CB1660DE	1600	600	740	£222.00

- D-end brackets included as standard
- D-end only fits a 2 person unit

TOP FINISHES // FRAME FINISH



- Modular bench desking range, ideal for modern offices with scope to expand
- Horizontal and vertical cable management options available



DESKING

// 03

We believe that a desk isn't just a place that you do your work; it's your personal space and therefore, an extension of your personality. Our desking ranges have been carefully selected to cater for you, and your working environments.

CONTENTS

- 30 Cable Managed Leg
- 32 Goalpost Leg
- 34 Panel Plus
- 36 Panel
- 38 Twin Upright
- 40 Single Upright
- 42 Eco 18
- 44 Desk Accessories

CABLE MANAGED LEG

5YR
COMPONENT
GUARANTEE

25MM
TOP
THICKNESS

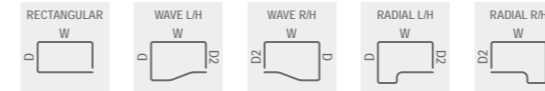

600 DEEP RECTANGULAR DESK

	Dimensions			RRP
	W	D	H	
CAB8060REC	800	600	730	£242.00
CAB1260REC	1200	600	730	£302.00
CAB1460REC	1400	600	730	£312.00
CAB1660REC	1600	600	730	£322.00
CAB1860REC	1800	600	730	£332.00

800 DEEP RECTANGULAR DESK

	Dimensions			RRP
	W	D	H	
CAB8080REC	800	800	730	£252.00
CAB1280REC	1200	800	730	£312.00
CAB1480REC	1400	800	730	£322.00
CAB1680REC	1600	800	730	£332.00
CAB1880REC	1800	800	730	£342.00

WAVE DESK

		Dimensions			RRP	
		W	D	H		
CAB1410LHWAV	L/H	1400	1000	730	800	£352.00
CAB1410RHWAV	L/H	1400	1000	730	800	£352.00
CAB1610LHWAV	R/H	1600	1000	730	800	£372.00
CAB1610RHWAV	R/H	1600	1000	730	800	£372.00

RADIAL DESK

		Dimensions			RRP	
		W	D	H		
CAB1212(*)RAD	L/H & R/H	1200	1200	730	800	£375.00
CAB1412(*)RAD	L/H & R/H	1400	1200	730	800	£400.00
CAB1612(*)RAD	L/H & R/H	1600	1200	730	800	£428.00
CAB1812(*)RAD	L/H & R/H	1800	1200	730	800	£438.00

* Please specify LH or RH in code, e.g CAB1212LHRAD for left hand desk

TOP FINISHES // FRAME FINISH



- Integrated cable management to ensure a safe and tidy work space
- For stocked screens, see page 60



GOALPOST LEG

5YR
COMPONENT
GUARANTEE

25MM
TOP
THICKNESS

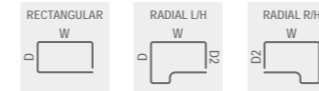

600 DEEP RECTANGULAR DESK

	Dimensions			RRP
	W	D	H	
GP1260REC	1200	600	730	£242.00
GP1460REC	1400	600	730	£252.00
GP1660REC	1600	600	730	£272.00
GP1860REC	1800	600	730	£282.00

800 DEEP RECTANGULAR DESK

	Dimensions			RRP
	W	D	H	
GP1280REC	1200	800	730	£252.00
GP1480REC	1400	800	730	£262.00
GP1680REC	1600	800	730	£282.00
GP1880REC	1800	800	730	£292.00

RECTANGULAR DESK WITH RETURN

		Dimensions			RRP
		W	D	H	
GP1680LHRET	L/H	1600	1800	730	£402.00
GP1680RHRET	R/H	1600	1800	730	£402.00
GP1880LHRET	L/H	1800	1800	730	£413.00
GP1880RHRET	R/H	1800	1800	730	£413.00

RADIAL DESK

		Dimensions			RRP
		W	D	H	
GP1212(*)RAD	L/H & R/H	1200	1200	730	£350.00
GP1412(*)RAD	L/H & R/H	1400	1200	730	£380.00
GP1612(*)RAD	L/H & R/H	1600	1200	730	£402.00
GP1812(*)RAD	L/H & R/H	1800	1200	730	£420.00

* Please specify LH or RH in code, e.g GP1212LHRAD for left hand desk

TOP FINISHES // FRAME FINISHES



- Ultra modern goalpost leg with shallow modesty panel
- For stocked screens, see page 60



PANEL PLUS

FOR MATCHING STORAGE - SEE PAGE 68

5 YR COMPONENT GUARANTEE

25 MM TOP THICKNESS



600 DEEP RECTANGULAR DESK

	Dimensions			RRP
	W	D	H	
PP8060REC	800	600	730	£177.00
PP1260REC	1200	600	730	£217.00
PP1460REC	1400	600	730	£250.00
PP1660REC	1600	600	730	£260.00
PP1860REC	1800	600	730	£286.00

800 DEEP RECTANGULAR DESK

	Dimensions			RRP
	W	D	H	
PP8080REC	800	800	730	£184.00
PP1280REC	1200	800	730	£227.00
PP1480REC	1400	800	730	£260.00
PP1680REC	1600	800	730	£270.00
PP1880REC	1800	800	730	£298.00

WAVE DESK

		Dimensions			RRP	
		W	D	H		
PP1410LHWAV	L/H	1400	1000	730	800	£282.00
PP1410RHWAV	R/H	1400	1000	730	800	£282.00
PP1610LHWAV	L/H	1600	1000	730	800	£302.00
PP1610RHWAV	R/H	1600	1000	730	800	£302.00

RADIAL DESK

		Dimensions			RRP	
		W	D	H		
PP1212(*)RAD	L/H & R/H	1200	1200	730	800	£252.00
PP1412(*)RAD	L/H & R/H	1400	1200	730	800	£282.00
PP1612(*)RAD	L/H & R/H	1600	1200	730	800	£292.00
PP1812(*)RAD	L/H & R/H	1800	1200	730	800	£382.00

* Please specify LH or RH in code, e.g PP1212LHRAD for left hand desk

TOP FINISHES



- All desks come with white legs and modesty panels
- Contemporary panel desk with integrated grey cable ports
- Metal to metal fixings for added strength
- Adjustable feet for levelling on uneven floors
- For stocked screens, see page 60



PANEL

5YR
COMPONENT
GUARANTEE

25MM
TOP
THICKNESS

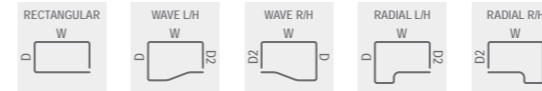

600 DEEP RECTANGULAR DESK

	Dimensions			RRP
	W	D	H	
PAN8060REC	800	600	730	£177.00
PAN1260REC	1200	600	730	£217.00
PAN1460REC	1400	600	730	£250.00
PAN1660REC	1600	600	730	£260.00
PAN1860REC	1800	600	730	£286.00

800 DEEP RECTANGULAR DESK

	Dimensions			RRP
	W	D	H	
PAN8080REC	800	800	730	£184.00
PAN1280REC	1200	800	730	£227.00
PAN1480REC	1400	800	730	£260.00
PAN1680REC	1600	800	730	£270.00
PAN1880REC	1800	800	730	£298.00

WAVE DESK

		Dimensions			RRP	
		W	D	H		
PAN1410LHWAV	L/H	1400	1000	730	800	£282.00
PAN1410RHWAV	R/H	1400	1000	730	800	£282.00
PAN1610LHWAV	L/H	1600	1000	730	800	£302.00
PAN1610RHWAV	R/H	1600	1000	730	800	£302.00

RADIAL DESK

		Dimensions			RRP	
		W	D	H		
PAN1212(*)RAD	L/H & R/H	1200	1200	730	800	£252.00
PAN1412(*)RAD	L/H & R/H	1400	1200	730	800	£282.00
PAN1612(*)RAD	L/H & R/H	1600	1200	730	800	£292.00
PAN1812(*)RAD	L/H & R/H	1800	1200	730	800	£382.00

* Please specify LH or RH in code, e.g PAN1212LHRAD for left hand desk

TOP FINISHES // FRAME FINISH



- Contemporary panel desk with integrated grey cable ports
- Metal to metal fixings for strength
- Adjustable feet for levelling on uneven floors
- For stocked screens, see page 60



TWIN UPRIGHT LEG

5YR
COMPONENT
GUARANTEE

25MM
TOP
THICKNESS

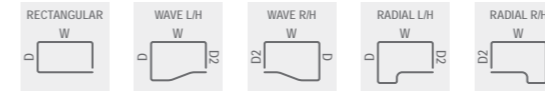

600 DEEP RECTANGULAR DESK

	Dimensions			RRP
	W	D	H	
TWU8060REC	800	600	730	£177.00
TWU1260REC	1200	600	730	£217.00
TWU1460REC	1400	600	730	£250.00
TWU1660REC	1600	600	730	£260.00
TWU1860REC	1800	600	730	£286.00

800 DEEP RECTANGULAR DESK

	Dimensions			RRP
	W	D	H	
TWU8080REC	800	800	730	£184.00
TWU1280REC	1200	800	730	£227.00
TWU1480REC	1400	800	730	£260.00
TWU1680REC	1600	800	730	£270.00
TWU1880REC	1800	800	730	£298.00

WAVE DESK

		Dimensions			RRP	
		W	D	H		
TWU1410LHWAV	L/H	1400	1000	730	800	£282.00
TWU1410RHWAV	R/H	1400	1000	730	800	£282.00
TWU1610LHWAV	L/H	1600	1000	730	800	£302.00
TWU1610RHWAV	R/H	1600	1000	730	800	£302.00

RADIAL DESK

		Dimensions			RRP	
		W	D	H		
TWU1212(*)RAD	L/H & R/H	1200	1200	730	800	£252.00
TWU1412(*)RAD	L/H & R/H	1400	1200	730	800	£282.00
TWU1612(*)RAD	L/H & R/H	1600	1200	730	800	£292.00
TWU1812(*)RAD	L/H & R/H	1800	1200	730	800	£382.00

* Please specify LH or RH in code, e.g TWU1212LHRAD for left hand desk

TOP FINISHES // FRAME FINISH



- A cost-effective workstation range with white or silver cantilever legs and a range of wooden desktop finishes
- Grey cable ports supplied as standard
- Adjustable feet for levelling on uneven floors
- For stocked screens, see page 60



SINGLE UPRIGHT LEG

5YR
COMPONENT
GUARANTEE

25MM
TOP
THICKNESS

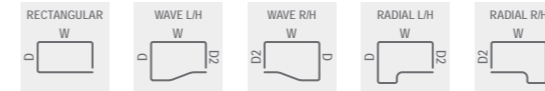

600 DEEP RECTANGULAR DESK

	Dimensions			RRP
	W	D	H	
SU8060REC	800	600	730	£177.00
SU1260REC	1200	600	730	£217.00
SU1460REC	1400	600	730	£250.00
SU1660REC	1600	600	730	£260.00
SU1860REC	1800	600	730	£286.00

800 DEEP RECTANGULAR DESK

	Dimensions			RRP
	W	D	H	
SU8080REC	800	800	730	£184.00
SU1280REC	1200	800	730	£227.00
SU1480REC	1400	800	730	£260.00
SU1680REC	1600	800	730	£270.00
SU1880REC	1800	800	730	£298.00

WAVE DESK

		Dimensions			RRP	
		W	D	H		
SU1410LHWAV	L/H	1400	1000	730	800	£282.00
SU1410RHWAV	R/H	1400	1000	730	800	£282.00
SU1610LHWAV	L/H	1600	1000	730	800	£302.00
SU1610RHWAV	R/H	1600	1000	730	800	£302.00

RADIAL DESK

		Dimensions			RRP	
		W	D	H		
SU1212(*)RAD	L/H & R/H	1200	1200	730	800	£252.00
SU1412(*)RAD	L/H & R/H	1400	1200	730	800	£282.00
SU1612(*)RAD	L/H & R/H	1600	1200	730	800	£292.00
SU1812(*)RAD	L/H & R/H	1800	1200	730	800	£382.00

* Please specify LH or RH in code, e.g SU1212LHRAD for left hand desk

TOP FINISHES // FRAME FINISH



- Modern cantilever leg desk with integrated grey cable ports
- Adjustable feet for levelling on uneven floors
- Modesty panels included
- For stocked screens, see page 60



ECO 18

FOR MATCHING STORAGE - SEE PAGE 69

5YR COMPONENT GUARANTEE

18MM TOP THICKNESS



SINGLE DESK

	Dimensions			RRP
	W	D	H	
EF1275REC	1200	750	730	£151.00
EF1575REC	1500	750	730	£181.00
EF1875REC	1800	750	730	£191.00



SINGLE DESK & 2 DRAWER PEDESTAL

	Dimensions			RRP
	W	D	H	
EF1275REC2DP	1200	750	730	£252.00
EF1575REC2DP	1500	750	730	£282.00
EF1875REC2DP	1800	750	730	£282.00



SINGLE DESK & 3 DRAWER PEDESTAL

	Dimensions			RRP
	W	D	H	
EF1275REC3DP	1200	750	730	£252.00
EF1575REC3DP	1500	750	730	£282.00
EF1875REC3DP	1800	750	730	£282.00



SINGLE DESK & 2 + 3 DRAWER PEDESTALS

	Dimensions			RRP
	W	D	H	
EF1575REC5DP	1500	750	730	£352.00
EF1875REC5DP	1800	750	730	£382.00



PANEL DESK

	Dimensions			RRP
	W	D	H	
EP1075REC	1000	750	726	£141.00
EP1275REC	1200	750	726	£151.00
EP1575REC	1500	750	726	£171.00



2 & 3 DRAWER MOBILE PEDESTALS

		Dimensions			RRP
		W	D	H	
EMP2D	2 Drawer	1500	750	525	£181.00
EMP3D	3 Drawer	1800	750	525	£181.00

TOP FINISHES



BE BAVARIAN BEECH OK SORANO OAK WH WHITE



DESK ACCESSORIES



POLE MOUNTED MONITOR ARM

	RRP
MBMA Available in black, silver and white	£78.00

- Cable management clips
- Includes pre-assembled clamp and through desk fixing
- Installed in under 2 minutes without the use of any tools



TWIN POLE MOUNTED MONITOR ARM

	RRP
MBTA Available in black, silver and white	£114.00

- Cable management clips
- Includes pre-assembled clamp and through desk fixing
- Installed in under 2 minutes without the use of any tools



SINGLE SPRING ASSISTED MONITOR ARM

	RRP
SGAMA Available in black and white	£259.00

- Discrete cable management



TWIN SPRING ASSISTED MONITOR ARM

	RRP
TGAMA Available in black and white	£382.00

- Discrete cable management
- Screens must be the same make, size and weight on either side



MAINS LEAD TO 3 POLE FEMALE CONNECTOR

	Length	RRP
PMCB2M	2m	£27.00
PMCB3M	3m	£30.00
PMCB4M	4m	£35.00
PMCB5M	5m	£39.00



POWER MODULES

		RRP
UPM203	2 point power socket	£42.00
UPM303	3 point power socket	£58.00
UPM403	4 point power socket	£68.00

- Power Modules can be linked in series with connector leads (see below connector leads)
- UK individually fused 5A power sockets
- Only available in black



MAGNETIC SINGLE CABLE RISER

	Colour	RRP
CABMCRSV	Silver	£21.00
CABMCRWH	White	£21.00

- Fits Goalpost leg desk, Premium Bench and Bench



VERTICAL CABLE MANAGER

	RRP
CBS Available in black, silver and white	£38.00

- Flexible design provides protection and movement
- Can accommodate cables totalling up to approximately 2.5cm x 2.5cm



DESKTOP POWER MODULES

		RRP
DM02	2 power sockets & twin USB ports	£160.00
DM03	2 power sockets, twin USB ports & 1 data port	£176.00
DM04	2 power sockets & 2 data ports	£94.00

- Does not come with power lead as standard
- Available in black and white
- Clamps to the back of the desk
- Sockets all individually fused plus 1 spare fuse per socket in unique holder



POWER MODULES

		RRP
PM2BK	Power module	£183.00
PMCB3M	3m power cable	£30.00

- Power module cable: 1 x UK socket, 2 x smart charge, 500mm lead, 3m length
- Fits in cable port hole

- A sturdy steel mesh basket ensures cables are neat, safe and visible
- Can be cut to required length

BASKET STYLE CABLE TRAY

		Dimensions W	RRP
WB800SV	For 800 desk	600	£51.00
WB1000SV	For 1000 desk	800	£58.00
WB1200SV	For 1200 desk	1000	£61.00
WB1400SV	For 1400 desk	1200	£67.00
WB1600SV	For 1600 desk	14800	£73.00



SCREENS

// 04

Collaborative working is a must when you're in an office environment, but it doesn't mean you can't have privacy. We can ensure you have the correct amount of personal space and privacy while working alongside and opposite colleagues. Our wide range of screens also allow you to attach storage solutions such as paper trays and pen potholders.

CONTENTS

- 48 Divide Type 1 Screen - Single Toolrail
 - 49 Divide Type 2 Screen - Triple Toolrail
 - 50 Mobile Screens
 - 52 Contempo Screens
 - 53 Elco Screens
 - 54 Lyle Desk Screens
 - 55 Toolrail Screens
 - 56 Panel Screens
 - 57 Screen Accessories
 - 58 Screen Finish Guide
- 60 Mangnum Screens

5 YR
COMPONENT
GUARANTEE

MADE
TO
ORDER
21 DAYS

MOBILE SCREENS



- 30mm screen thickness
- Superior build quality
- Robust aluminium extruded frame
- Lightweight construction
- Fully upholstered in fire retardant fabric
- Trim mounted mobile feet included
- Epoxy powder coated frame available in white or silver

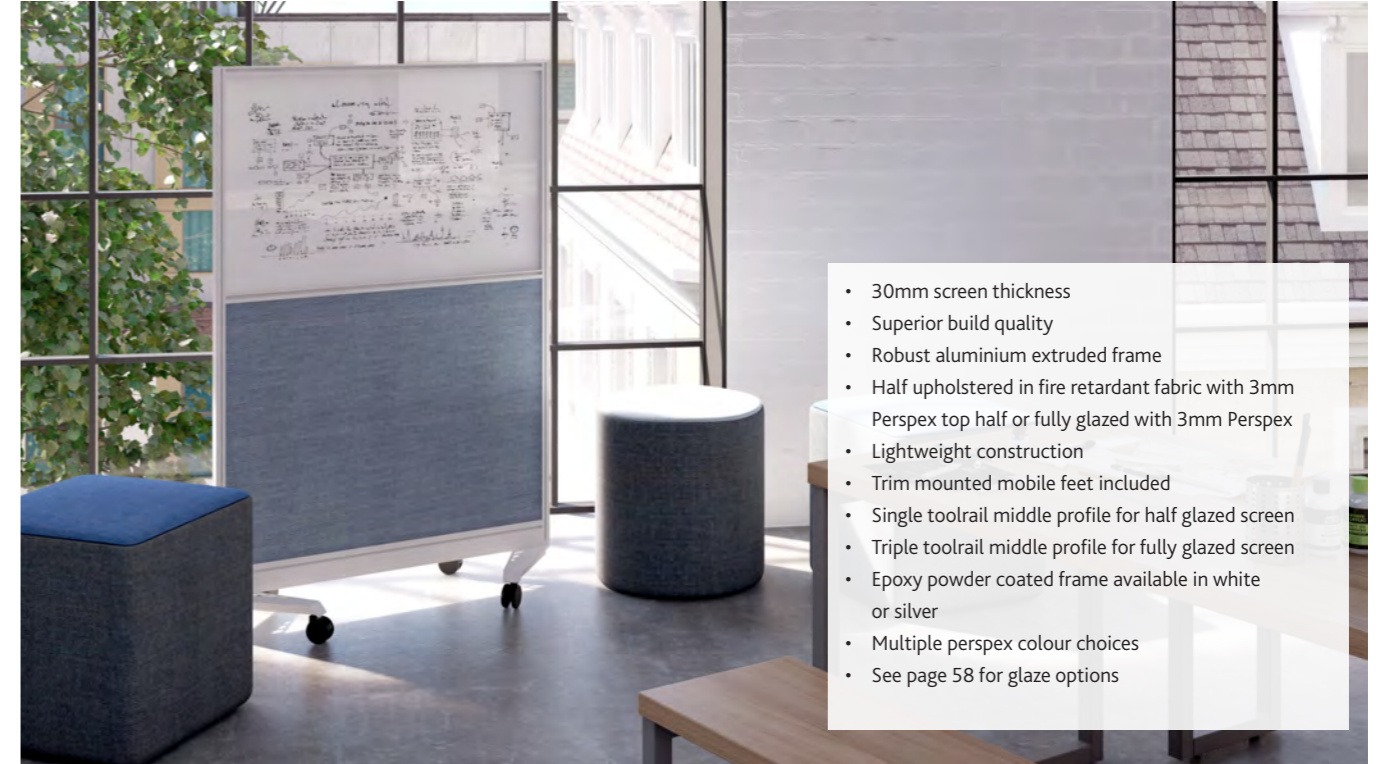

- 30mm screen thickness
- Superior build quality
- Robust aluminium extruded frame
- Half upholstered in fire retardant fabric with 3mm Perspex top half or fully glazed with 3mm Perspex
- Lightweight construction
- Trim mounted mobile feet included
- Single toolrail middle profile for half glazed screen
- Triple toolrail middle profile for fully glazed screen
- Epoxy powder coated frame available in white or silver
- Multiple perspex colour choices
- See page 58 for glaze options

FABRIC FINISH // FRAME FINISH



FABRIC FINISH // FRAME FINISH



TYPE 1 - SINGLE TOOLRAIL

	Dimensions		RRP
	W	H	
TKT15KT0815UN	800	1500	£543.00
TKT15KT1015UN	1000	1500	£621.00
TKT15KT0818UN	800	1800	£558.00
TKT15KT1018UN	1000	1800	£646.00

TYPE 2 - TRIPLE TOOLRAIL

	Dimensions		RRP
	W	H	
TKT25KT0815UN	800	1500	£558.00
TKT25KT1015UN	1000	1500	£621.00
TKT25KT0818UN	800	1800	£573.00
TKT25KT1018UN	1000	1800	£662.00

TYPE 3 - HALF GLAZED

	Dimensions		RRP
	W	H	
TKT3SKT0815UN	800	1500	£621.00
TKT3SKT1015UN	1000	1500	£646.00
TKT3SKT0818UN	800	1800	£646.00
TKT3SKT1018UN	1000	1800	£672.00

TYPE 4 - FULLY GLAZED

	Dimensions		RRP
	W	H	
TKT4SKT0815UN	800	1500	£672.00
TKT4SKT1015UN	1000	1500	£697.00
TKT4SKT0818UN	800	1800	£697.00
TKT4SKT1018UN	1000	1800	£723.00

* Priced in Band 1 fabric

5 YR COMPONENT GUARANTEE
MADE TO ORDER
21 DAYS

CONTEMPO SCREENS

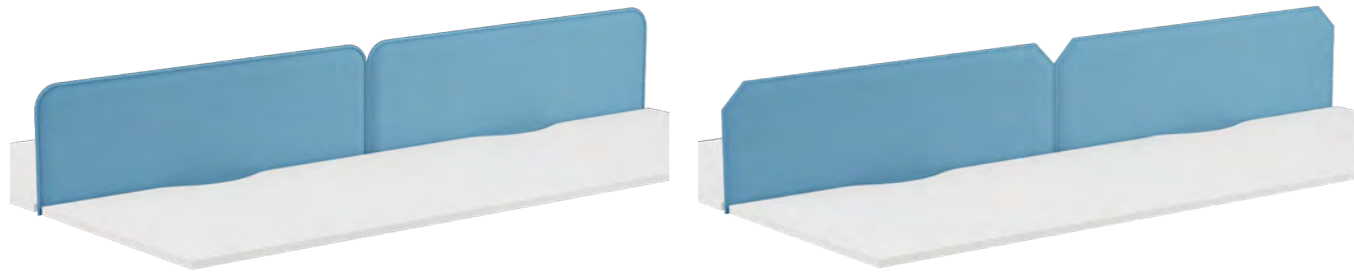

TYPE 1 - ROUNDED

	Dimensions		RRP
	W	H	
TKT1COSY12UN	1200	380	£229.00
TKT1COSY14UN	1400	380	£250.00
TKT1COSY16UN	1600	380	£270.00

TYPE 3 - CHAMFER

	Dimensions		RRP
	W	H	
TKT3COSY12UN	1200	380	£229.00
TKT3COSY14UN	1400	380	£250.00
TKT3COSY16UN	1600	380	£270.00



- Beautifully detailed exposed stitching
- Fully upholstered in fire retardant fabric
- Hand crafted
- Screen thickness 25mm (approx)

// **IMPORTANT NOTE:** Contempo screens are only available in Blazer Lite fabric

CONTEMPO, ELCO & LYLE BRACKETS

- These are fitted with a 'metal-to-screen' connection bracket and requires 2 x TKDMSTRSC per screen

Contempo, Elco & Lyle Brackets	RRP
TKDMSTRSC	£19.00

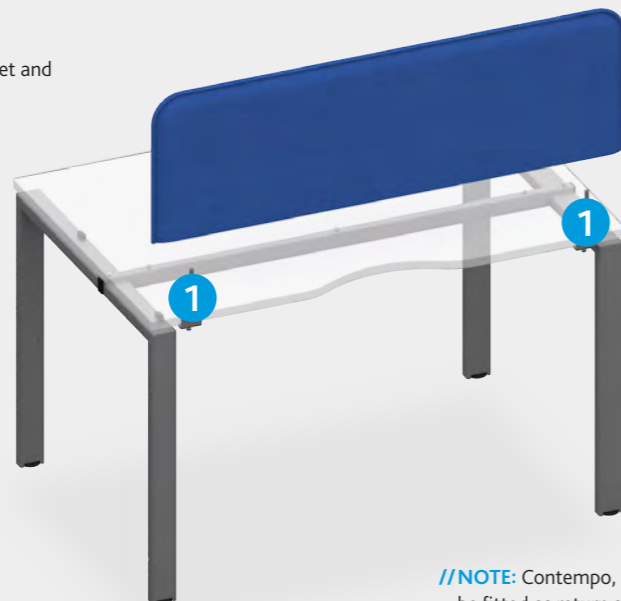

// **NOTE:** Contempo, Elco & Lyle cannot be fitted as return screens.

5 YR COMPONENT GUARANTEE
MADE TO ORDER
21 DAYS

ELCO SCREENS



STRAIGHT

	Dimensions		RRP
	W	H	
TKDMSECST12UN	1200	380	£146.00
TKDMSECST14UN	1400	380	£156.00
TKDMSECST16UN	1600	380	£177.00

ARC

	Dimensions		RRP
	W	H	
TKDMSECA12UN	1200	380	£146.00
TKDMSECA14UN	1400	380	£156.00
TKDMSECA16UN	1600	380	£177.00



- Defines the working zone on bench and desk systems
 - Allows privacy; increasing productivity
 - 25mm screen thickness
 - Fully upholstered screen with matching fabric trim
 - Fully upholstered in fire retardant fabric
 - Accessory hanging facility available, see page 57
 - Radiused on all four corners
 - Superior build quality
 - Grip is simple and fast to reposition - no bracket needed
- // **NOTE:** Only fits 25mm desktops

GRIP

	Dimensions		RRP
	W	H	
TKDMSECGR60UN	600	352	£209.00

FINISHES



* Priced in Band 1 fabric



LYLE DESK SCREENS

5 YR COMPONENT GUARANTEE
MADE TO ORDER
21 DAYS

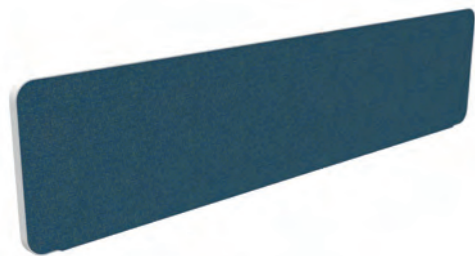

STRAIGHT

	Dimensions		RRP
	W	H	
TKDMSLYST10UN	1000	380	£104.00
TKDMSLYST12UN	1200	380	£114.00
TKDMSLYST14UN	1400	380	£124.00
TKDMSLYST16UN	1600	380	£135.00

WAVE

	Dimensions		RRP
	W	H	
TKDMSLYWV10UN	1000	380	£104.00
TKDMSLYWV12UN	1200	380	£114.00
TKDMSLYWV14UN	1400	380	£124.00
TKDMSLYWV16UN	1600	380	£135.00

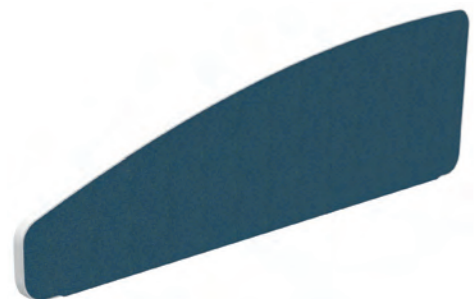

• See page 52 for brackets

ARC

	Dimensions		RRP
	W	H	
TKDMSLYA10UN	1000	380	£104.00
TKDMSLYA12UN	1200	380	£114.00
TKDMSLYA14UN	1400	380	£124.00
TKDMSLYA16UN	1600	380	£135.00

FABRIC FINISH // TRIM FINISH



* Priced in Band 1 fabric

TOOLRAIL SCREENS

5 YR COMPONENT GUARANTEE
MADE TO ORDER
21 DAYS

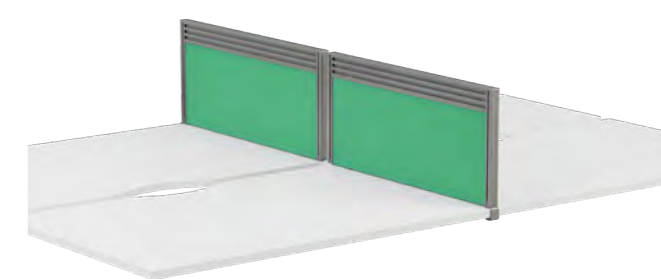
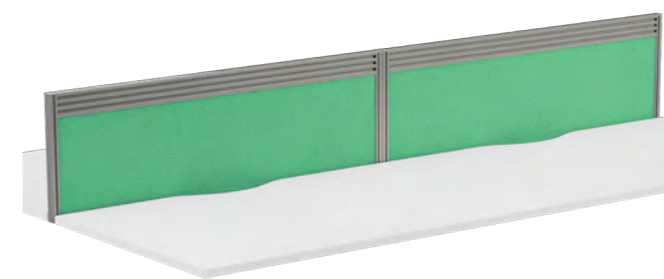

TYPE 2 TOOLBAR

	Dimensions		RRP
	W	H	
TKDMSTR12UN	1200	380	£232.00
TKDMSTR14UN	1400	380	£243.00
TKDMSTR16UN	1600	380	£254.00

TYPE 2 RETURN TOOLBAR

	Dimensions		RRP
	W	H	
TKDMSTR80RUN	785	380	£126.00



TYPE 3 HALF GLAZED

	Dimensions		RRP
	W	H	
TKDMSHG12UN	1200	380	£209.00
TKDMSHG14UN	1400	380	£229.00
TKDMSHG16UN	1600	380	£250.00

TYPE 3 RETURN HALF GLAZED

	Dimensions		RRP
	W	H	
TKDMSHG80RUN	785	380	£177.00

TOOLRAIL & PANEL BRACKETS

These are fitted with 'metal-to-metal' connection brackets as follows:

- 1 Back to back Bench requires 1 x TKDMSENDSCP per screen (come in pairs)
- 2 Single Bench requires 2 x TKDMSTRSC per screen

- 3 Mid run return screens requires 1 x TKDMSRETSB, which includes 1 x TKDMSRETS to clamp the leading edge of the screen and 1 x TKSLINKKIT to join the return screen to the spine screens
- 4 End of run return screens requires 1 x TKDMSRETEORSB, which includes 1 x TKDMSRETEORS and 1 x TKSLINKKIT

Toolrail & Panel can be fitted as return screens on Bench. Each return screen requires brackets as follows:

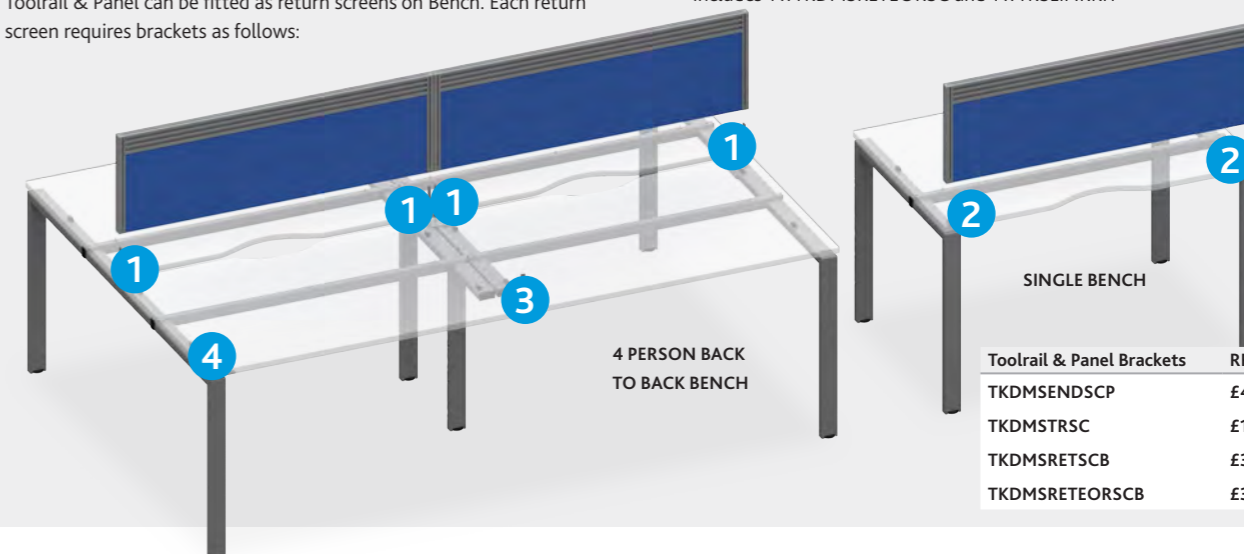

Toolrail & Panel Brackets	RRP
TKDMSENDSCP	£40.00
TKDMSTRSC	£19.00
TKDMSRETSB	£33.00
TKDMSRETEORSB	£33.00

5 YR
COMPONENT
GUARANTEE

MADE
TO
ORDER
21 DAYS

PANEL SCREENS

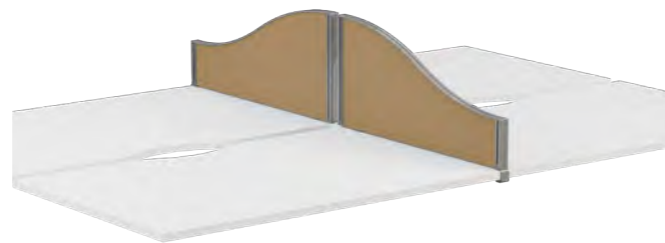

TYPE 5 WAVE

	Dimensions		RRP
	W	H	
TKDMSW12UN	1200	380	£126.00
TKDMSW14UN	1400	380	£146.00
TKDMSW16UN	1600	380	£167.00

TYPE 5 RETURN WAVE

	Dimensions		RRP
	W	H	
TKDMSW80RUN	785	380	£105.00

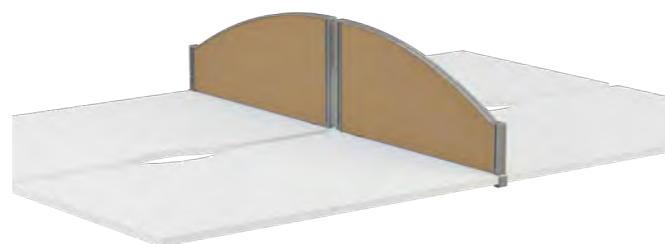

TYPE 6 ARC

	Dimensions		RRP
	W	H	
TKDMSA12UN	1200	380	£126.00
TKDMSA14UN	1400	380	£146.00
TKDMSA16UN	1600	380	£167.00

TYPE 6 RETURN ARC

	Dimensions		RRP
	W	H	
TKDMSA80RUN	785	380	£105.00



TYPE 7 STRAIGHT PVC TOP

	Dimensions		RRP
	W	H	
TKDMSP12	1200	380	£144.00
TKDMSP14	1400	380	£148.00
TKDMSP16	1600	380	£155.00

TYPE 7 RETURN STRAIGHT PVC TOP

	Dimensions		RRP
	W	H	
TKDMSP80RUN	785	380	£105.00

FABRIC FINISH // FRAME FINISH



* Priced in Band 1 fabric

SCREEN ACCESSORIES

MADE
TO
ORDER
21 DAYS

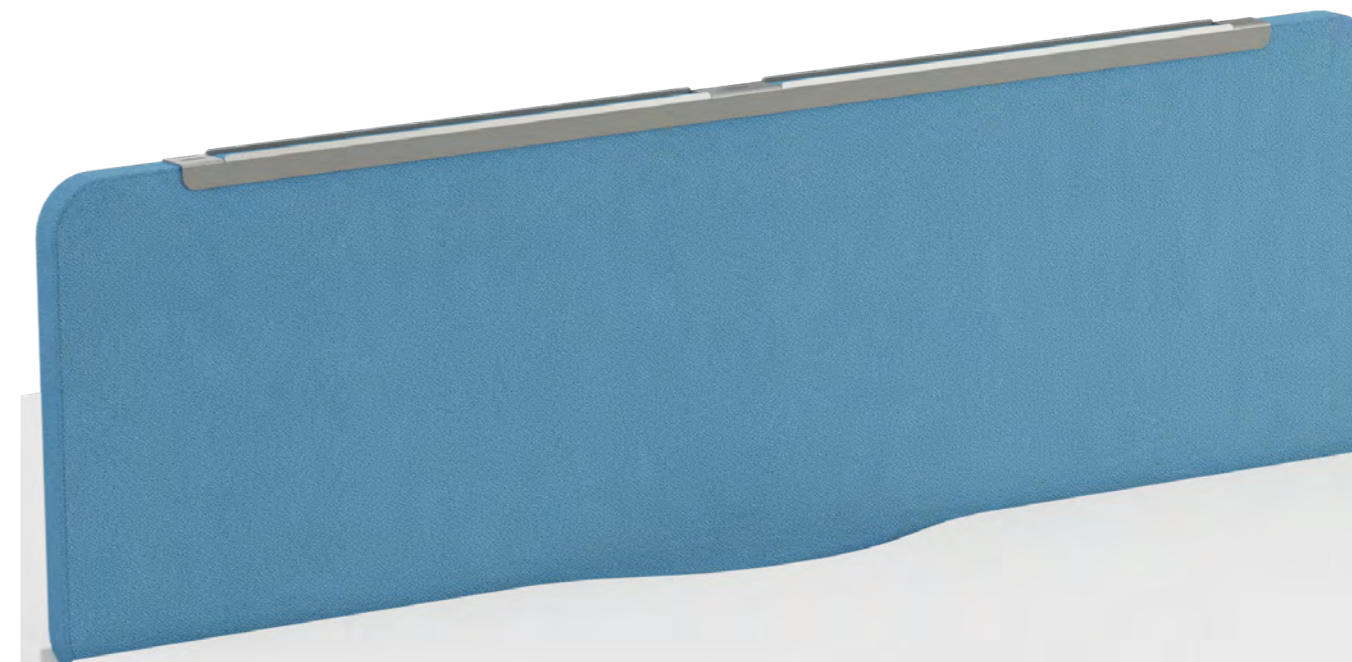

ACCESSORY RAIL

	Dimensions		RRP
	Rail Width	To Fit Screen Width	
TKDMSTR08AR	600	800	£26.00
TKDMSTR10AR	800	1000	£28.00
TKDMSTR12AR	1000	1200	£31.00
TKDMSTR14AR	1200	1400	£33.00
TKDMSTR16AR	1400	1600	£38.00

- Handy accessory rail simply slots over the top of a straight screen, allowing screen accessories to be utilised
- Available in 5 different widths to suit varying screen sizes
- Epoxy powder coated to match desk frames

// NOTE: Sizes are to suit screen size - actual lengths are 200mm shorter

FINISHES



Letter Tray



Pencil Pot



Trinket Pot



Phone Holder

TOOLRAIL ACCESSORIES

	Dimensions	RRP
TKDMSTRPTA4	A4 Letter Tray	£30.00
TKDMSTRPEN	Pencil Pot	£25.00
TKDMSTRTP	Trinket Pot	£25.00
TKDMSTRPH	Phone Holder	£25.00

FINISHES



- A unique set of screen hung accessories to provide personal storage above the desk
- All accessories can be hung from the Elco accessory rail and Toolrail screens
- The phone holder is compatible with a wide range of smartphones, such as an iPhone X for size reference
- The pencil and trinket pots help tidy worksurfaces by lifting personal effects off the desktop
- Available in white and silver finish

SCREEN FINISH GUIDE

Too much choice? Let us help you with that. Whether it's a Granite grey, an Ocean blue or a Jezebel red; we've created a guide to help you pick your perfect fabric.

Should you need more information regarding screen finishes and their application, please give us a call.

TOOLRAIL / PANEL / DIVIDE / MOBILE SCREENS

Screen Fabric Bands			
Band 1	Band 2	Band 3	Band 4
Cara	Lucia L2 Racer Phoenix Era Castillo Citadel Sonus Rivet Lucia CS	Gravity Advantage Manhattan Canopy Sprint Xtreme Chateau X2 Velocity Nexus Blazer Lite Urban Synergy 170 Main Line Plus Aspect Patina	24/7 Flax 24/7+ Main Line Flax Hi-Tech Synergy Hemp Landscape Synergy Silk Intervene Plain & Texture Blazer Aquarius Track Oxygen Halcyon - Linden Halcyon - Cedar Halcyon - Poplar

ELCO SCREENS

Screen Fabric Bands			
Band 1	Band 2	Band 3	Band 4
Cara	Lucia L2 Racer Era Castillo Sonus Lucia CS	Nexus Blazer Lite Synergy 170	—

CONTEMPO SCREENS

Screen Fabric Bands			
Band 1	Band 2	Band 3	Band 4
—	—	Blazer Lite	—

PERSPEX SELECTION

Colour	Toolrail	Divide	Mobile
Aurora Violet	•	•	•
Perfect Plum	•	•	•
Acid Green	•	•	—
Chilli Red	•	•	•
Mandarin Orange	•	•	•
Lime Zest	•	•	•
Glacier Green	•	•	•
Electric Blue	•	•	•
Polar White	•	•	•
Slate Grey	•	•	•
Opal (drywipe)	—	—	•

//NOTE: For whiteboard use, please select the Opal perspex as this is the only dry wipe finish



MAGNUM SCREENS

5 YR
COMPONENT
GUARANTEE



FINISHES



- Strong and durable construction
- Made from fire retardant materials
- Feet included

FLOOR STANDING SCREEN

	Dimensions			RRP
	W	D	H	
FST1212S	1200	25	1200	£209.00
FST1216S	1200	25	1600	£234.00
FST1218S	1200	25	1800	£260.00
FST1412S	1400	25	1200	£234.00
FST1416S	1400	25	1600	£260.00
FST1418S	1400	25	1800	£285.00
FST1612S	1600	25	1200	£260.00
FST1616S	1600	25	1600	£285.00
FST1618S	1600	25	1800	£311.00



STRAIGHT SCREEN

	Dimensions			RRP
	W	D	H	
DMS1200S	1200	25	400	£91.00
DMS1400S	1400	25	400	£101.00
DMS1600S	1600	25	400	£111.00
DMS1800S	1800	25	400	£121.00

- Strong and durable construction
- Made from fire retardant materials
- G-clamp brackets included



WOODEN STORAGE

// 05

The mountain of paperwork you keep meaning to file, the plant you forget to water or the office marketing material that is stacking up on your desk; there's always a reason for needing more storage and worktop space. Our wooden storage has been designed quite simply to make organisation easy.

CONTENTS

- 64 Wooden Pedestals
- 65 Wooden Filing
- 66 Wooden Bookcases
- 67 Wooden Cupboards
- 68 One Panel Plus
- 69 Eco 18 Premium Bookcases & Cupboards
- 69 Eco 18 Bookcases & Cupboards

WOODEN PEDESTALS

- 5 YR COMPONENT GUARANTEE
- A4 SUSPENSION FILING
- FS SUSPENSION FILING
- 100% BOTTOM DRAWER EXTENSION



• Fixed glides

UNDER DESK STATIC PEDESTAL

	Dimensions			RRP
	W	D	H	
TESUDP3	404	500	690	£276.00



• Hidden castors

3 DRAWER DESK HIGH MOBILE PEDESTAL

	Dimensions			RRP
	W	D	H	
TESUHMP3	400	500	636	£276.00



2 DRAWER MOBILE PEDESTAL

	Dimensions			RRP
	W	D	H	
TESMP2	404	500	595	£196.00



3 DRAWER MOBILE PEDESTAL

	Dimensions			RRP
	W	D	H	
TESMP3	400	500	595	£196.00

// NOTE: Does not support A4 or Foolscap filing



2 DRAWER FIXED PEDESTAL

	Dimensions			RRP
	W	D	H	
TESHP2	404	500	495	£191.00
TESHP2/655	404	655	495	£193.00

// NOTE: TESHP2/655 can only be used with single upright desks



3 DRAWER FIXED PEDESTAL

	Dimensions			RRP
	W	D	H	
TESHP3	400	500	495	£191.00
TESHP3/655	400	655	495	£193.00

// NOTE: TESHP3/655 can only be used with single upright desks. Does not support A4 or Foolscap filing

FINISHES

- BE BEECH
- NO NOVA OAK
- DW DARK WALNUT
- GO GREY OAK
- MA MAPLE
- WH WHITE

WOODEN FILING

- 5 YR COMPONENT GUARANTEE
- A4 SUSPENSION FILING
- FS SUSPENSION FILING
- ANTI-TILT
- 100% DRAWER EXTENSION



DESK HIGH PEDESTAL

	Dimensions			RRP
	W	D	H	
TESDHP3	404	600	730	£276.00
TESDHP3/800	404	800	730	£347.00



HEAVY DUTY SIDE FILER

	Dimensions			RRP
	W	D	H	
TKDH800SF	800	600	730	£658.00



2 & 3 DRAWER FILING CABINETS

	Dimensions			RRP
	W	D	H	
TES2FC	464	600	710	£352.00
TES3FC	464	600	1030	£382.00



4 DRAWER FILING CABINET

	Dimensions			RRP
	W	D	H	
TES4FC	464	600	1365	£483.00

FINISHES

- BE BEECH
- NO NOVA OAK
- DW DARK WALNUT
- GO GREY OAK
- MA MAPLE
- WH WHITE



WOODEN BOOKCASES

5^{YR}
COMPONENT
GUARANTEE

18^{MM}
SHELVES &
BACK
THICKNESS



FINISHES

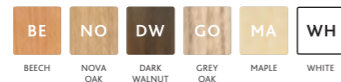

- 18mm one piece MFC back panel
- 25mm top and bottom panels
- Black adjustable feet for levelling
- Fully adjustable shelves



	Shelves	Dimensions			RRP
		W	D	H	
WDS745	1	800	450	730	£181.00
WDS845	1	800	450	800	£181.00
WDS1045	2	800	450	1000	£232.00
WDS1245	3	800	450	1200	£262.00
WDS1645	3	800	450	1600	£282.00
WDS1845	4	800	450	1800	£292.00
WDS2045	4	800	450	2000	£322.00

WOODEN CUPBOARDS

5^{YR}
COMPONENT
GUARANTEE

18^{MM}
SHELVES &
BACK
THICKNESS



FINISHES

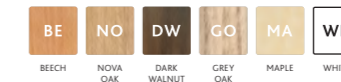

- 18mm one piece MFC back panel
- 25mm top and bottom panels
- Lockable doors with silver handles
- Black adjustable feet for levelling
- Fully adjustable shelves



	Shelves	Dimensions			RRP
		W	D	H	
WDS745CP	1	800	450	730	£242.00
WDS845CP	1	800	450	800	£242.00
WDS1045CP	2	800	450	1000	£302.00
WDS1245CP	3	800	450	1200	£342.00
WDS1645CP	3	800	450	1600	£362.00
WDS1845CP	4	800	450	1800	£382.00
WDS2045CP	4	800	450	2000	£423.00

PANEL PLUS CUPBOARDS

5 YR
COMPONENT
GUARANTEE

18 MM
SHELVES &
BACK
THICKNESS



DOOR FINISHES // FRAME FINISH

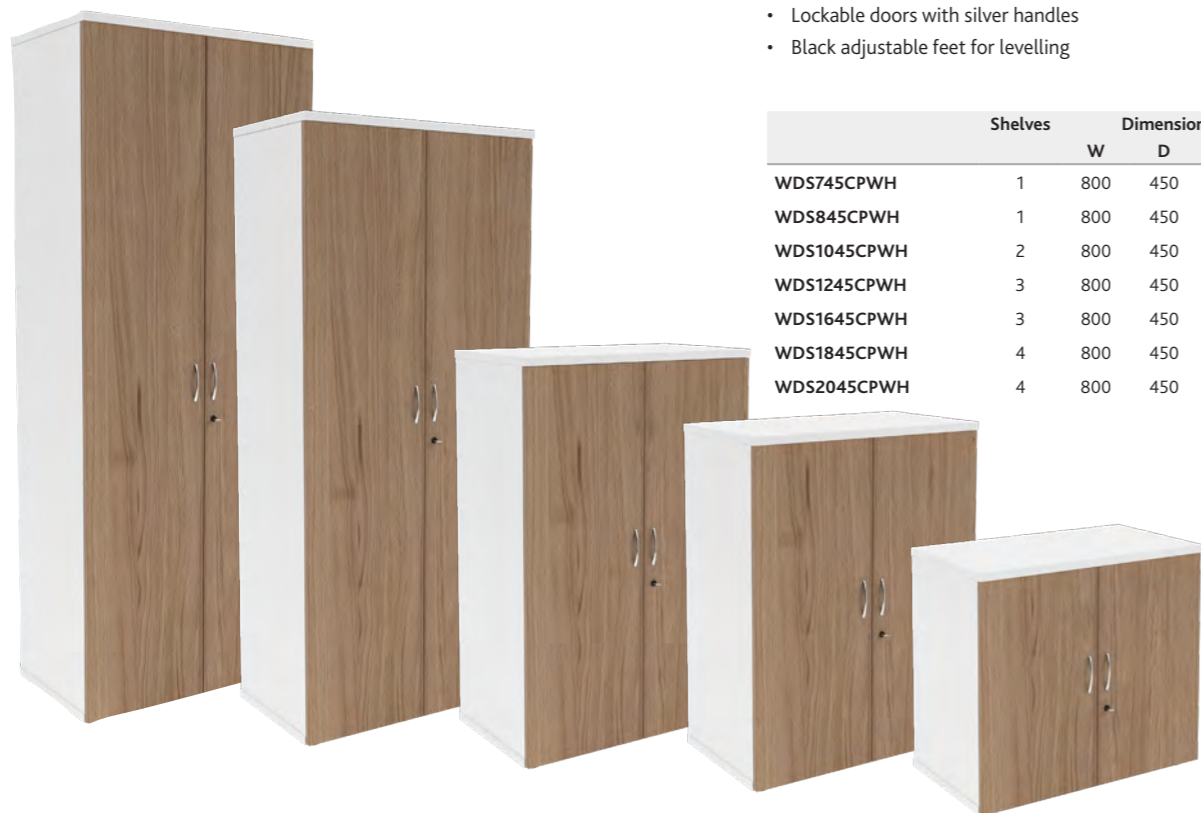

- 18mm one piece MFC back panel
- Lockable doors with silver handles
- Black adjustable feet for levelling

	Shelves	Dimensions			RRP
		W	D	H	
WDS745CPWH	1	800	450	730	£242.00
WDS845CPWH	1	800	450	800	£242.00
WDS1045CPWH	2	800	450	1000	£302.00
WDS1245CPWH	3	800	450	1200	£342.00
WDS1645CPWH	3	800	450	1600	£362.00
WDS1845CPWH	4	800	450	1800	£382.00
WDS2045CPWH	4	800	450	2000	£423.00

E&EO. All items are subject to VAT, where applicable.

ECO 18 PREMIUM BOOKCASES & CUPBOARDS

2 YR
COMPONENT
GUARANTEE

18 MM
SHELVES &
BACK
THICKNESS



- 18mm shelves & backs
- Fixed shelves
- Wood finishes match Eco 18 range only

	Shelves	Dimensions			RRP	
		W	D	H		
EP750BC	Bookcase	1	750	400	726	£201.00
EP800BC	Bookcase	1	750	400	800	£131.00
EP1200BC	Bookcase	2	750	400	1200	£151.00
EP1600BC	Bookcase	3	750	400	1600	£181.00
EP2000BC	Bookcase	4	750	400	2000	£217.00
EP800CP	Cupboard	1	750	400	800	£222.00
EP1200CP	Cupboard	2	750	400	1200	£263.00
EP1600CP	Cupboard	3	750	400	1600	£292.00
EP2000CP	Cupboard	4	750	400	2000	£317.00

FINISHES



ECO 18 BOOKCASES & CUPBOARDS

2 YR
COMPONENT
GUARANTEE

3 MM
BACK
THICKNESS



- 3mm one piece MFC back panel
- Floating shelves (apart from 1750 high which has 1 fixed shelf)
- Wood finishes match Eco 18 range only

	Shelves	Dimensions			RRP	
		W	D	H		
E800BC	Bookcase	1	750	400	800	£121.00
E1200BC	Bookcase	2	750	400	1200	£156.00
E1750BC	Bookcase	3	750	400	1750	£186.00
E800CP	Cupboard	1	750	400	800	£201.00
E1200CP	Cupboard	2	750	400	1200	£257.00
E1750CP	Cupboard	3	750	400	1750	£287.00

STEEL STORAGE

// 06

Inspired by our customers and designed with resilience in mind; this range of furniture is for the meticulous office worker, the organised freelancer and the problem-solving teacher. We have thought about how steel storage can cater for everybody and paid particular attention to adding elements of personalisation to ensure your space is your own.

CONTENTS

72	Talos Steel Pedestals	80	Talos Cupboards	92	Personal Effects Lockers
73	Talos Filing Cabinets	81	Bisley Contract Cupboards	93	High Capacity Storage Cupboards
74	Bisley Classic Filing	81	Bisley Essentials Cupboards	94	Dangerous Substance Safety Cabinets
74	Bisley Contract Filing	82	Office Plan Chests	95	Low Height Lockers
75	Bisley A4 Personal Home Filing	83	Office Lockers		
75	Bisley A4 Home Filing	84	Fire Resistant Safes		
76	Bisley Multidrawers	86	Safes		
77	Bisley Essentials Side Filers	88	Standard Lockers		
78	Talos Tambours	90	Multi-purpose Lockers		
79	Bisley Essentials Tambours	91	All White Lockers		

TALOS STEEL PEDESTALS

- 7YR COMPONENT GUARANTEE
- A4 SUSPENSION FILING
- FS SUSPENSION FILING
- LOCKABLE



MOBILE PEDESTAL

SLIMLINE MOBILE PEDESTAL

	Dimensions			RRP
	W	D	H	
TKUSMP3	380	470	615	£257.00

	Dimensions			RRP
	W	D	H	
TKUSSMP3	300	470	615	£257.00

- Pen tray included with this model

FINISHES



TALOS FILING CABINETS

- 7YR COMPONENT GUARANTEE
- A4 SUSPENSION FILING
- FS SUSPENSION FILING
- AT ANTI-TILT
- 100% DRAWER EXTENSION
- 40KG LOAD CAPACITY PER DRAWER
- LOCKABLE



FINISHES // TOP FINISHES

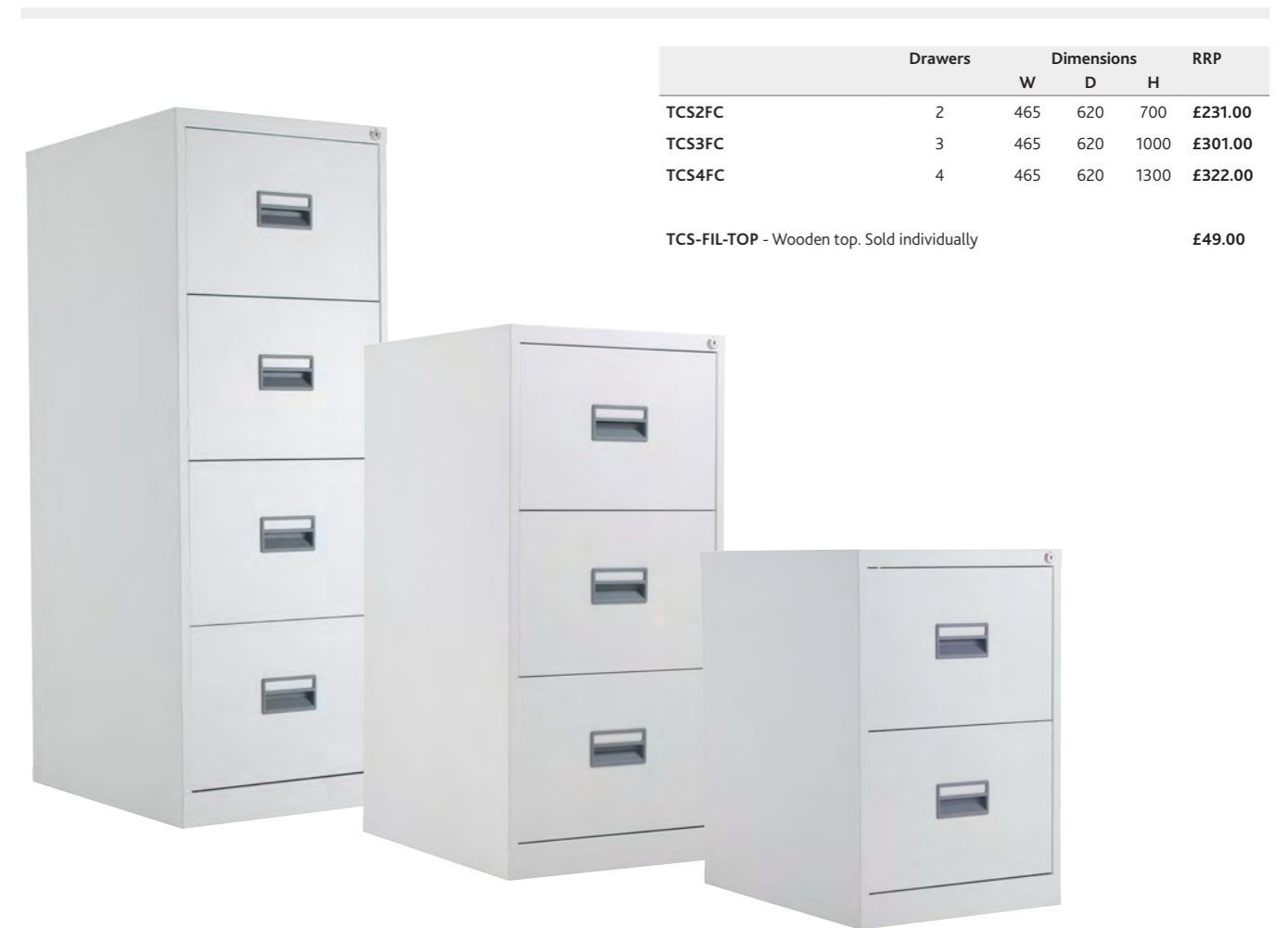

	Drawers	Dimensions			RRP
		W	D	H	
TCS2FC	2	465	620	700	£231.00
TCS3FC	3	465	620	1000	£301.00
TCS4FC	4	465	620	1300	£322.00

TCS-FIL-TOP - Wooden top. Sold individually £49.00

BISLEY CLASSIC FILING

10^{YR} COMPONENT GUARANTEE | **A4** SUSPENSION FILING | **FS** SUSPENSION FILING | **45^{KG}** LOAD CAPACITY PER DRAWER | LOCKABLE

- Built to last fully welded construction
- Double skin drawer fronts
- Suitable for fooscap and A4 filing



	Drawers	Dimensions			RRP
		W	D	H	
BS2E	2	470	622	711	£362.00
BS3E	3	470	622	1016	£443.00
BS4E	4	470	622	1321	£483.00

// NOTE: Each drawer can hold up to 45kg of hanging suspension files. For use with suspension files only. Drawer bottoms are not load bearing.

FINISHES



BISLEY

BISLEY CONTRACT FILING

5^{YR} COMPONENT GUARANTEE | **A4** SUSPENSION FILING | **FS** SUSPENSION FILING | **35^{KG}** LOAD CAPACITY PER DRAWER | LOCKABLE

- Best selling high quality filing cabinets
- Manufactured to meet British Standards for strength and stability
- Fitted with recessed handles
- Drawer label holders
- Central locking
- Anti-tilt to prevent more than one drawer being opened at a time



	Drawers	Dimensions			RRP
		W	D	H	
AOC2	2	470	622	711	£302.00
AOC3	3	470	622	1016	£342.00
AOC4	4	470	622	1321	£352.00

// NOTE: Each drawer can hold up to 35kg of hanging suspension files. For use with suspension files only. Drawer bottoms are not load bearing.

FINISHES



BISLEY

E&EO. All items are subject to VAT, where applicable.

BISLEY A4 PERSONAL HOME FILING

2^{YR} COMPONENT GUARANTEE | **A4** SUSPENSION FILING | **15^{KG}** LOAD CAPACITY PER DRAWER | LOCKABLE

- Suitable for use with A4 suspension files
- Drawer loading capacity of 15kg
- Suitable for fooscap filing
- 2 drawer supplied with 1 lock and 2 keys
- 3 and 4 drawer units supplied with 2 locks and 2 keys for each
- Moulded plastic centre pull handle



	Drawers	Dimensions			RRP
		W	D	H	
A4PHF2D	2	413	400	672	£141.00
A4PHF3D	3	413	400	1015	£222.00
A4PHF4D	4	413	400	1321	£237.00

// NOTE: 2 drawer and 3 drawer models available in all colours, 4 drawer only available in goose grey, black and grey/blue

FINISHES



BISLEY

BISLEY A4 HOME FILING

2^{YR} COMPONENT GUARANTEE | **A4** SUSPENSION FILING | **15^{KG}** LOAD CAPACITY PER DRAWER | LOCKABLE

- Lightweight storage ideal for the home office
- Suitable for use with A4 suspension files
- Drawer loading capacity of 15kg
- Units supplied with 1 lock and 2 keys
- Single action lock secures 2 drawers (bottom 2 on 3 drawer)
- Moulded plastic centre pull handle



	Drawers	Dimensions			RRP
		W	D	H	
A4NMHF3D	3 Drawer non mobile	413	400	672	£171.00
A4MHF2D	2 Drawer mobile	413	400	529	£131.00
A4MHF3D	3 Drawer mobile	413	400	529	£180.00

// NOTE: 3 drawer non mobile model available in all colours with 2 and 3 drawer mobile models only available in goose grey and black

FINISHES



BISLEY

BISLEY MULTIDRAWERS

5YR
COMPONENT
GUARANTEE

100%
DRAWER
EXTENSION



• Drawer height - 87mm high



	Drawers	Dimensions			RRP
		W	D	H	
H29/6NL	6	279	380	590	£161.00
H39/9NL	9	279	380	860	£222.00

• Drawer height - 51mm high



	Drawers	Dimensions			RRP
		W	D	H	
H29/10NL	10	279	380	590	£181.00
H39/15NL	15	279	380	860	£232.00



BASE OPTION

	RRP
HMDPLNTH - Black plinth base, single for 10 & 15 drawer	£25.00



// NOTE
Compartment trays available,
please speak to sales for details



STOCKED FINISH



GOOSE GREY

MADE TO ORDER FINISHES



BISLEY ESSENTIALS SIDE FILERS

A4
SUSPENSION
FILING

FS
SUSPENSION
FILING

5YR
COMPONENT
GUARANTEE

MADE TO ORDER
10 DAYS



STOCKED FINISHES



LIGHT GREY
CHALK WHITE

MTO FINISHES



BLACK SILVER TRAFFIC WHITE GOOSE GREY ANTHRACITE

- Ideal for offices where floor space is limited
- Fits A4 and foolscap suspension filing
- All units have adjustable feet



	Drawers	Dimensions			RRP
		W	D	H	
ESSF2D	2	800	470	693	£734.00
ESSF3D	3	800	470	1000	£804.00
ESSF4D	4	800	470	1300	£1106.00



BISLEY

TALOS TAMBOURS

7^{YR} COMPONENT GUARANTEE
A4 SUSPENSION FILING
FS SUSPENSION FILING
50^{KG} LOAD CAPACITY
 LOCKABLE



FINISHES // OPTIONAL WOODEN TOP FINISHES

WH GR // BE NO DW GO MA WH
WHITE GREY BEECH NOVA OAK DARK WALNUT GREY OAK MAPLE WHITE

- A flexible alternative to wooden storage
- Lockable side-opening shutter door
- Able to mix flat shelves and suspension frames together
- Included shelves can be used for under shelf filing

	Shelves	Dimensions			RRP
		W	D	H	
TCSOT1050	2	1000	450	1050	£535.00
TCSOT1950	4	1000	450	1950	£696.00

- TCSOTFF - Roll out Tambour filing frame. Sold individually **£161.00**
- TCS-TAM-SHELF - Dual purpose Tambour shelf. Sold individually **£38.00**
- TCS-TAM-TOP - Wooden top. Sold individually **£54.00**



TCSOTFF



BISLEY ESSENTIALS TAMBOURS

5^{YR} COMPONENT GUARANTEE
 LOCKABLE



STOCKED FINISHES

OS BS GG
OAK & SILVER BEECH & SILVER GOOSE GREY

MTO ORDER FINISHES

AV7 AV1 AB9 ARN BA5 AA3
LIGHT GREY BLACK CHALK SILVER TRAFFIC WHITE ANTHRACITE

SHUTTER FINISHES

1 5 EW SL 9
LIGHT GREY BLACK EXTRA WHITE SILVER DARK GREY

- Adjustable feet
- Priced empty, for interior fittings see page 81



	Dimensions			RRP		
	W	D	H	GG	OS	BS
ESSOT101	1000	470	1015	£498.00	£498.00	£498.00
ESSOT158	1000	470	1585	£609.00	£609.00	£609.00
ESSOT198	1000	470	1985	£719.00	£719.00	£719.00



BISLEY

TALOS CUPBOARDS

7^{YR} COMPONENT GUARANTEE
A4 SUSPENSION FILING
50^{KG} LOAD CAPACITY
 LOCKABLE



FINISHES // TOP FINISHES

WH GR // BE NO DW GO MA WH
 WHITE GREY BEECH NOVA OAK DARK WALNUT GREY OAK MAPLE WHITE

- A flexible alternative to wooden storage
- Square lockable handles
- Included shelves can be used for under shelf filing
- 180° door opening

	Shelves	Dimensions			RRP
		W	D	H	
TCSDDC1000	2	920	420	1000	£267.00
TCSDDC1790	4	920	420	1790	£367.00
TCSDDC1950	4	920	420	1950	£432.00

- TCS-SHELF-BK - Dual purpose cupboard shelf. Sold individually £28.00
- TCS-CUP-TOP - Wooden top. Sold individually £49.00

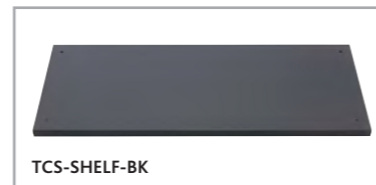

BISLEY CONTRACT CUPBOARDS

5^{YR} COMPONENT GUARANTEE
45^{KG} LOAD CAPACITY
 LOCKABLE



- 3 point locking system
- Included shelves can be used for under shelf filing

	Shelves	Dimensions			RRP
		W	D	H	
E402A01	1	914	400	1000	£322.00
E722A03	3	914	400	1806	£423.00
E782A04	4	914	400	1950	£483.00
E198P1/BLK - Extra dual purpose shelf, black only					£31.00

FINISHES

G/G C/C
 GOOSE GREY COFFEE CREAM



BISLEY

BISLEY ESSENTIALS CUPBOARDS

5^{YR} COMPONENT GUARANTEE
 LOCKABLE



- Wide range of interior fittings available
- Levelling feet
- Standard shelves can be used for under shelf filing

	Dimensions			RRP
	W	D	H	
ESCB101	914	470	1015	£352.00
ESCB158	914	470	1585	£402.00
ESCB198	914	470	1985	£503.00

- YETBUS10 - Standard shelf £34.00
- ROSF/BLK - Roll-out suspension filing frame £149.00
- BSSPDP1BLK - Slotted shelf £59.00
- SHDV85P5PS - Pack of 5 dividers for slotted shelf £62.00
- ROSH/BLK - Roll-out shelf £131.00

STOCKED FINISH

G/G
 GOOSE GREY

MTO ORDER FINISHES

AV7 AV1 AB9 ARN BA5 AA3
 LIGHT GREY BLACK CHALK SILVER TRAFFIC WHITE ANTHRACITE



BISLEY

5 YR
COMPONENT
GUARANTEE

MADE
TO
ORDER
20 DAYS

OFFICE PLAN CHESTS



FINISHES // FRAME FINISH



A1 SQUARE FRAME PLAN CHESTS

	Drawers	Dimensions			RRP
		W	D	H	
PC8 A1	8	992	707	830	£725.00
PC6 A1	6	992	707	830	£554.00
PC3 A1	3	992	707	830	£418.00
PC1 A1	1	992	707	830	£379.00

A0 SQUARE FRAME PLAN CHESTS

	Drawers	Dimensions			RRP
		W	D	H	
PC8 A0	8	1340	960	830	£993.00
PC6 A0	6	1340	960	830	£745.00
PC3 A0	3	1340	960	830	£501.00
PC1 A0	1	1340	960	830	£439.00

• Will accommodate paper size 841 x 594mm

• Will accommodate paper size 1189 x 841mm
 • Top panel: 18mm with 2mm edge
 • Leg frame: 25mm square tubing

• Refer to trade price list. E&EO. All items are subject to VAT, where applicable.

5 YR
COMPONENT
GUARANTEE

MADE
TO
ORDER
20 DAYS

OFFICE RECYCLE CUPBOARDS



	Apertures	Dimensions			RRP
		W	D	H	
RU8/4/7	2	800	400	725	£458.00
RU8/5/7	2	800	500	725	£508.00
RU8/4/10	2	800	400	1000	£508.00
RU8/5/10	2	800	500	1000	£564.00
RU10/4/7	3	990	400	725	£551.00
RU10/5/7	3	990	500	725	£609.00
RUB - Replacement boxes		300	300	600	£14.00

MADE TO ORDER FINISHES



2 YR COMPONENT GUARANTEE
MADE TO ORDER
7 DAYS

FIRE RESISTANT SAFES



FS2254E

FS2252K

FSDPI08

WORLD CLASS VERTICAL FIRE FILE FS2250K/E SERIES

	Drawers	Weight KG	Dimensions			RRP
			W	D	H	
FS2252K	2	140	525	675	720	£1353.00
FS2252E	2	140	525	675	720	£1508.00
FS2254K	4	266	525	675	1405	£1991.00
FS2254E	4	266	525	675	1405	£2146.00
FSDPI08 - Data protection insert		20				£441.00



Electronic Locking (E), Key Locking (K). 90 Minutes fire protection for paper records & data when FSDPI08 is used. Water resistant seals prevent damage to contents against sprinkler systems. Able to accommodate Foolscap, A4 & A5 files using width adjustable rails. Independent drawer locking allows any combinations of open or locked drawers.



FS1283E

FS1282E



TITAN FS1280E SERIES

	Litres	Weight KG	Dimensions			RRP
			W	D	H	
S1281E	19	28	412	363	360	£320.00
FS1282E	25	34	350	430	410	£366.00
FS1283E	36	53	400	440	515	£413.00

60 Minutes fire protection for paper records & digital media, DVD's & USB sticks. Recommended for £2,000 overnight cash cover or £20,000 for valuables. High security electronic lock. Drop tested from 9.1 meters & suitable for base fixing (bolts supplied).



FSDPI03

DATA PROTECTION

	RRP
FSDPI03	£366.00

Insert for FS1510K/E Series (Except FS1511K/E) & FS1910E Series



FS1912E

FS1913E

FS1914E



FS1513K

FS1514K/E

FS1512K



FIRE COMMANDER FS1910E SERIES

	Litres	Weight KG	Dimensions			RRP
			W	D	H	
FS1911E	220	260	690	650	1160	£1828.00
FS1912E	338	340	690	650	1685	£2715.00
FS1913E	332	358	950	650	1160	£3186.00
FS1914E	626	554	1125	650	1685	£3691.00

Tested to the Swedish NT Fire 017 120 Paper standard, providing 120 minutes fire protection for paper documents. Tested to MTC DIP120 - 60DM Fire Test standard providing up to 60 minutes fire protection for DVDs, memory sticks and hard drives. Recommended for an overnight cash risk of £2,500.00 or £25,000.00 valuables. Fitted with a high security and user friendly electronic lock with clear LED display. Supplied with height adjustable shelves.



FIRE RANGER FS1510K/E SERIES

	Litres	Weight KG	Dimensions			RRP
			W	D	H	
FS1511K	230	77	600	520	1225	£1078.00
FS1511E	230	77	600	520	1225	£1180.00
FS1512K	359	106	930	520	1225	£1388.00
FS1512E	359	106	930	520	1225	£1449.00
FS1513K	615	152	930	520	1950	£1737.00
FS1513E	615	152	930	520	1950	£1830.00
FS1514K	851	194	1255	520	1950	£2169.00
FS1514E	851	194	1255	520	1950	£2275.00

Electronic Locking (E), Key Locking (K). 30 Minutes fire protection for paper records. High security VDS Class 1 key lock or electronic locking with LED display. Recommended for £1,500 overnight cash cover or £15,000 for valuables. Height adjustable shelves that also include hanging rails for lateral files.

Refer to trade price list. E&EO. All items are subject to VAT, where applicable.

KEY

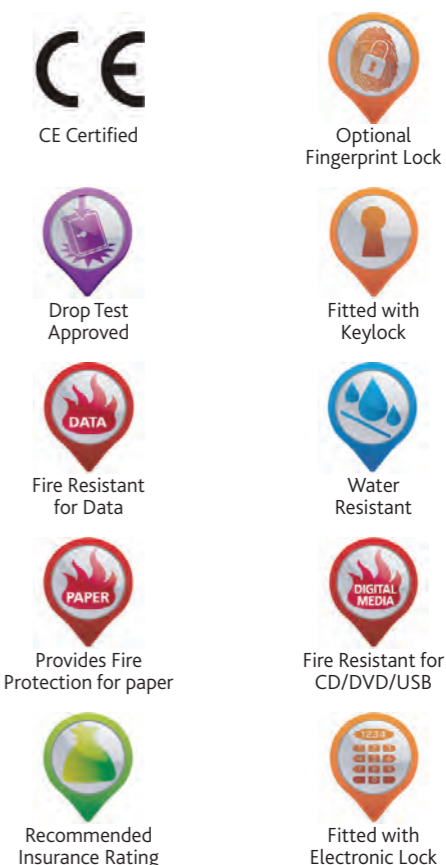

2 YR COMPONENT GUARANTEE
MADE TO ORDER
7 DAYS

SAFES



ELECTRONIC KEY SAFES KS0030E SERIES

	Hooks	Weight KG	Dimensions			RRP
			W	D	H	
KS0031E	30	6.5	300	100	280	£138.00
KS0032E	48	7.5	300	100	360	£146.00
KS0033E	144	20	430	130	660	£241.00

PRODUCT

	Hooks	Weight KG	Dimensions			RRP
			W	D	H	
KC0601K	42	4	270	80	350	£80.00
KC0602K	64	6	300	80	450	£108.00
KC0603K	100	7	380	80	550	£140.00
KC0604K	200	11	380	140	550	£183.00
KC0605K	300	14	380	205	550	£268.00
KC0606K	400	20	730	140	550	£319.00
KC0607K	600	28	730	205	550	£436.00

High quality electronic locking with override key lock (2 keys supplied). Suitable for 30, 48 & 144 keys. Coloured key rings & tags supplied. Key deposit slot allows keys to be deposited without opening the safe. Ready prepared for floor or wall fixing (bolts supplied).

Cabinets are manufactured with a high quality cylinder key lock supplied with 2 keys. Each unit comes with adjustable hook bars and number labels with pre-drilled fixing holes for wall mounting. Finished in a high quality durable powder coated finish.

COMPACT HOME / OFFICE SS0800E SERIES

	Litres	Weight KG	Dimensions			RRP
			W	D	H	
SS0801E	10	6	310	200	200	£97.00
SS0802E	17	8	350	250	250	£113.00
SS0803E	34	12	450	365	250	£171.00
SS0804E	51	19	350	310	500	£203.00
SS0805E	88	23	370	445	560	£248.00



Recommended for £1,000 overnight cash cover or £10,000 for valuables. Advanced user friendly electronic locking with high security anti-tamper or bounce solenoid locking system. Ready prepared for fixing to the floor or wall. Ready prepared for floor or wall fixing (bolts supplied). Fitted with bright internal LED light.



FORTRESS SS1180K/E SERIES

	Litres	Weight KG	Dimensions			RRP
			W	D	H	
SS1181K	7	15	350	300	220	£252.00
SS1181E	7	15	350	300	220	£409.00
SS1182K	24	25	450	350	350	£337.00
SS1182E	24	25	450	350	350	£497.00
SS1183K	42	37	450	350	550	£456.00
SS1183E	42	37	450	350	550	£616.00

ECB.S Certified & AIS (Association of Insurance Surveyors) Approved Electronic Locking (E), Key Locking (K). Tested to European S2 Security Standard (EN14450) providing £4,000 cash cover and £40,000 valuable cover. Anti drill plates for added security. High security VDS Class 1 double bitting key lock or electronic lock & time delay. Ready prepared for floor fixing (bolts supplied for concrete).



LYNX SS1170 SERIES

	Litres	Weight KG	Dimensions			RRP
			W	D	H	
SS1171K	11	20	350	300	280	£217.00
SS1172K	22	29	420	380	300	£241.00
SS1173K	52	52	420	380	605	£422.00

Recommended for £3,000 overnight cash cover or £30,000 for valuables. Fitted with high security VDS Class 1 key lock (2 keys supplied). The door is secured by twin live locking bolts. Ready prepared for floor or wall fixing (bolts supplied).

KEY



CE Certified

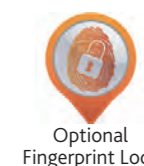

Optional Fingerprint Lock

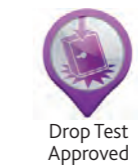

Drop Test Approved

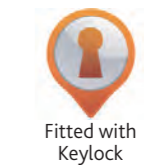

Fitted with Keylock

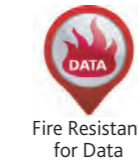

Fire Resistant for Data



Water Resistant



Provides Fire Protection for paper



Fire Resistant for CD/DVD/USB



Recommended Insurance Rating



Fitted with Electronic Lock

STANDARD LOCKERS

2 YR
COMPONENT
GUARANTEE

MADE
TO
ORDER
20 DAYS

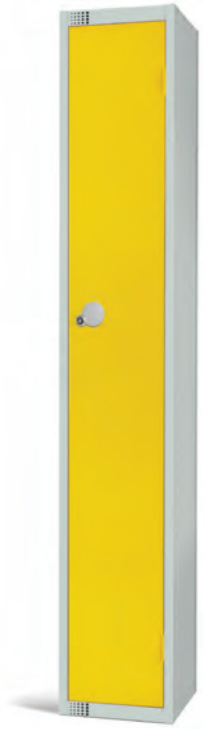

Supplied with a top shelf and double coat hook



Supplied with a double coat hook in each compartment



Supplied with no internal fittings



Supplied with no internal fittings

SINGLE DOOR LOCKER

	Dimensions			RRP		
	W	D	H	Single	Nest of 2	Nest of 3
1830301	300	300	1800	£120.00	£232.00	£343.00
1830451	300	450	1800	£143.00	£277.00	£413.00
1845451	450	450	1800	£172.00	N/A	NA

TWO DOOR LOCKER

	Dimensions			RRP		
	W	D	H	Single	Nest of 2	Nest of 3
1830302	300	300	1800	£149.00	£314.00	£476.00
1830452	300	450	1800	£165.00	£321.00	£478.00
1845452	450	450	1800	£193.00	NA	NA

FIVE DOOR LOCKER

	Dimensions			RRP	
	W	D	H	Single	Nest of 2
1830305	300	300	1800	£204.00	£399.00
1830455	300	450	1800	£222.00	£434.00

SIX DOOR LOCKER

	Dimensions			RRP
	W	D	H	Single
1830306	300	300	1800	£221.00
1830456	300	450	1800	£236.00



Supplied with no internal fittings

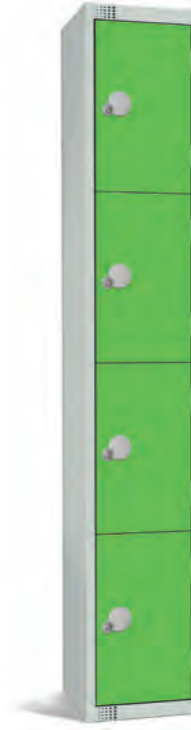

Supplied with no internal fittings

THREE DOOR LOCKER

	Dimensions			RRP		
	W	D	H	Single	Nest of 2	Nest of 3
1830303	300	300	1800	£164.00	£318.00	£476.00
1830453	300	450	1800	£185.00	£359.00	£540.00

FOUR DOOR LOCKER

	Dimensions			RRP	
	W	D	H	Single	Nest of 2
1830304	300	300	1800	£179.00	£353.00
1830454	300	450	1800	£200.00	£392.00
1845454	450	450	1800	£232.00	NA



Supplied with no internal fittings

EIGHT DOOR LOCKER

	Dimensions			RRP
	W	D	H	Single
1830308	300	300	1800	£278.00
1830458	300	450	1800	£308.00

DOOR FINISHES // FRAME FINISH



OPTIONS

	Dimensions			RRP
	W	D	H	Single
ST3030 - sloping top	300	300	150	£20.00
ST3045 - sloping top	300	450	150	£22.00
ST4545 - sloping top	450	450	150	£24.00
4 Digit combination lock - with master key override				POA
Master key				POA
Hanging rail				POA
Number plate and key fob				POA
£1 coin return or token return lock				POA
Additional keys				POA
Electronic combination lock				POA
Fitting for padlock - specify at time of order				POA



4 Digit Combination Lock



Hanging Rail



£1 Coin Return or Token Return Lock

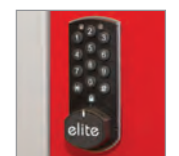

Electronic Combination Lock

• Refer to trade price list. E&EO. All items are subject to VAT, where applicable.

2 YR
COMPONENT
GUARANTEE

MADE
TO
ORDER
20 DAYS

MULTI-PURPOSE LOCKERS



COMBI LOCKER

Model	Dimensions			RRP
	W	D	H	
1845N	450	450	1800	£221.00

- Ideal for the storage of personal clothing and equipment
- The locker comes with a vertical hanging compartment and smaller storage compartments
- Supplied with grey carcass

CLEAN & DIRTY LOCKER

Model	Dimensions			RRP
	W	D	H	
1845CD	450	450	1800	£194.00

- Two vertical hanging compartments to separate workwear and daywear
- Integral seat and stands are available along with a sloping top and lock options
- Supplied with a grey carcass

DOOR FINISHES // FRAME FINISH



TWO PERSON LOCKER

Model	Dimensions			RRP
	W	D	H	
1845TP	450	450	1800	£253.00

- A space saving unit for two users
- Each user would have a vertical hanging and a personal possession compartment
- Supplied with a grey carcass

TWIN LOCKER

Model	Dimensions			RRP
	W	D	H	
1845TW	450	450	1800	£229.00

- This space saving unit accommodates two users each having a slim vertical storage compartment with shelf and double coat hook
- A sloping top option available
- Supplied with a grey carcass

• Refer to trade price list. E&EO. All items are subject to VAT, where applicable.

ALL WHITE LOCKERS

2 YR
COMPONENT
GUARANTEE

MADE
TO
ORDER
20 DAYS



SINGLE DOOR LOCKER

Model	Dimensions			RRP
	W	D	H	
1830301W	300	300	1800	£124.00
1830451W	300	450	1800	£149.00

- Anti-bacterial powder coating RAL 9010
- Robust steel construction
- Contains AbbeysteelTM reduced CO2

TWO DOOR LOCKER

Model	Dimensions			RRP
	W	D	H	
1830302W	300	300	1800	£156.00
1830452W	300	450	1800	£172.00

- Anti-bacterial powder coating RAL 9010
- Robust steel construction
- Contains AbbeysteelTM reduced CO2

FINISH



FOUR DOOR LOCKER

Model	Dimensions			RRP
	W	D	H	
1830304W	300	300	1800	£187.00
1830454W	300	450	1800	£210.00

- Anti-bacterial powder coating RAL 9010
- Robust steel construction
- Contains AbbeysteelTM reduced CO2

SIX DOOR LOCKER

Model	Dimensions			RRP
	W	D	H	
1830306W	300	300	1800	£229.00
1830456W	300	450	1800	£245.00

- Anti-bacterial powder coating RAL 9010
- Robust steel construction
- Contains AbbeysteelTM reduced CO2

2 YR
COMPONENT
GUARANTEE

MADE
TO
ORDER
20 DAYS

PERSONAL EFFECTS LOCKERS

- High density storage
- 1800mm or 940mm high
- Improves workplace security
- Lock options available



FLOOR STANDING LOCKERS

		Dimensions			RRP
		W	D	H	
PEL20	20 Doors	450	380	1800	£539.00
PEL10	10 Doors	450	380	940	£328.00

DOOR FINISHES // FRAME FINISH



- Four and eight door available
- Available with charging ports, call sales for more details
- Supplied with two keys
- Keyless lock options available



WALL MOUNTABLE LOCKERS

		Dimensions			RRP
		W	D	H	
PEL4FT	4 Door	250	160	920	£210.00
PEL8FT	8 Door	250	160	920	£259.00
PEL4ST	4 Door with sloping top	250	160	920 / 990	£218.00
PEL8ST	8 Door with sloping top	250	160	920 / 990	£268.00

• Refer to trade price list. E&EO. All items are subject to VAT, where applicable.

HIGH CAPACITY STORAGE CUPBOARDS

2 YR
COMPONENT
GUARANTEE

MADE
TO
ORDER
20 DAYS



724518RED1

- High density secure storage of small valuable items
- Cupboard dimensions 1830h x 1120w x 457d mm
- Choice of three tray sizes: 75, 150 and 225mm high
- Cupboards and trays delivered separately



724518BLUE3



724518OPA2

	No. of trays	Tray size H	Tray colour	Dimensions			RRP
				W	D	H	
724518OPA1	51	75	Opaque	1120	457	1830	£1407.00
724518RED1	51	75	Red	1120	457	1830	£1407.00
724518BLUE1	51	75	Blue	1120	457	1830	£1407.00
724510OPA2	27	150	Opaque	1120	457	1830	£1153.00
724518RED2	27	150	Red	1120	457	1830	£1153.00
724518BLUE2	27	150	Blue	1120	457	1830	£1153.00
724518OPA3	18	225	Opaque	1120	457	1830	£965.00
724518RED3	18	225	Red	1120	457	1830	£965.00
724518BLUE3	18	225	Blue	1120	457	1830	£965.00

DOOR FINISHES // FRAME FINISH



1 YR COMPONENT GUARANTEE
MADE TO ORDER
20 DAYS

DANGEROUS SUBSTANCE SAFETY CABINETS



DANGEROUS SUBSTANCE CABINETS

	Shelves	Sump capacity	Sloping top	Locking	Dimensions			RRP
					W	D	H	
724818CSC	3	45Ltr	-	Yes	1220	457	1830	£695.00
723618CSC	3	36Ltr	Option	Yes	915	457	1830	£612.00
603618CSC	2	36Ltr	Option	Yes	915	457	1525	£575.00
393618CSC	1	30Ltr	Option	Yes	915	457	1000	£421.00
361818CSC	1	15Ltr	-	-	457	457	910	£321.00
283618CSC	1	30Ltr	Option	Yes	915	457	710	£384.00

SLOPING TOP ADD ON

	Dimensions			RRP
	W	D	H	
3618STUCSC	915	457	150	£103.00



MINI DANGEROUS SUBSTANCE CABINETS

	Shelves	Sump capacity	Sloping top	Locking	Dimensions			RRP
					W	D	H	
243618CSC	1	30Ltr	Option	Yes	915	457	610	£375.00
243615CSC	1	15Ltr	-	Yes	915	381	610	£366.00
301818CSC	1	10Ltr	-	-	457	457	760	£313.00
281812CSC	1	10Ltr	-	-	457	305	710	£289.00
281412CSC	1	5Ltr	-	-	355	305	710	£278.00
241818CSC	1	10Ltr	-	-	457	457	610	£301.00
181812CSC	1	5Ltr	-	-	457	305	457	£275.00

STANDS WITH ADJUSTABLE FEET

	Dimensions			RRP
	W	D	H	
3618STCSC	915	457	533	£136.00
1818STCSC	457	457	533	£129.00

IMPORTANT NOTICE:

In accordance with HSE guidelines and regulations, before these cabinets are placed into operational use, it is the responsibility of the user to ensure that the signage to be displayed is appropriate to the hazards associated with those chemicals or products to be stored within.

New GHS labelling will be supplied on dangerous substance cabinets, the primary label is the Flame meaning 'Flammable'...



Additional alternative labelling supplied loose includes 'Oxidizing' and 'Explosive'...



Labels are easy peel type to allow switching of the primary label. Additional GHS signage and chemical information segregation chart supplied within each cabinet.

Refer to trade price list. E&EO. All items are subject to VAT, where applicable.

2 YR COMPONENT GUARANTEE
MADE TO ORDER
20 DAYS

LOW HEIGHT LOCKERS



LOW HEIGHT 3 DOOR

	Dimensions			RRP
	W	D	H	
1330303	300	300	1370	£145.00
1330383	300	380	1370	£149.00
1330453	300	450	1370	£156.00

- Special low height 1370mm high
- Reinforced doors
- Lock options
- Perforated door option

CUBE

	Dimensions			RRP
	W	D	H	
303030C	300	300	300	£67.00
383838C	380	380	380	£74.00
454545C	450	450	450	£88.00

- Ideal for utilising awkward areas
- Bolted to form stacks or nests
- Locking option
- Perforated door option

DOOR FINISHES // FRAME FINISH



QUARTO

	Dimensions			RRP
	W	D	H	
513045QU	300	450	512	£83.00

- Ideal modular storage solution in difficult areas
- Pre-drilled for nesting
- Elite Guard Anti-bacterial powder coating
- Locking options
- Reinforced doors
- Perforated door option



DISABILITY LOCKER

	Dimensions			RRP
	W	D	H	
133030DL	300	300	1370	£137.00
133045DL	300	450	1370	£153.00

- Special height for disabled users
- Low level shelf
- Reinforced doors
- Double coat hook
- Locking options

PROJECT

// 07

Not up for colour matching across different ranges for a big project? Then don't. This UK made range of furniture has been carefully selected to allow you to choose full ranges with ease and have them delivered to your doorstep in an extremely timely fashion.

CONTENTS

98	Linnea Elevate - Height Adjustable	117	Storage Units
100	Linnea Elevate - Fixed Height	118	Optima Plus Meeting Tables
102	Linnea Bench	120	Optima Plus Conference Tables
106	Linnea Accessories		
108	Optima Plus Height Adjustable Desks		
110	Optima Plus		
112	Linnea & Optima Pedestals & Filing		
114	Linnea & Optima Bookcases		
115	Linnea & Optima Cupboards		
116	Optima Tambours		

LINNEA ELEVATE - HEIGHT ADJUSTABLE

5^{YR}
COMPONENT
GUARANTEE

25^{MM}
TOP
THICKNESS

MADE
TO
ORDER
20 DAYS



SINGLE RECTANGULAR

	Dimensions			RRP
	W	D	H	
LER12/8/HA	1200	800	710 - 890	£1341.00
LER14/8/HA	1400	800	710 - 890	£1353.00
LER16/8/HA	1600	800	710 - 890	£1367.00
LER18/8/HA	1800	800	710 - 890	£1380.00

SINGLE RECTANGULAR EXTENSION

	Dimensions			RRP
	W	D	H	
LER12/8/INT/HA	1200	800	710 - 890	£1341.00
LER14/8/INT/HA	1400	800	710 - 890	£1353.00
LER16/8/INT/HA	1600	800	710 - 890	£1367.00
LER18/8/INT/HA	1800	800	710 - 890	£1380.00

2 PERSON RECTANGULAR

	Dimensions			RRP
	W	D	H	
LE12/16/HA	1200	1600	710 - 890	£2506.00
LE14/16/HA	1400	1600	710 - 890	£2530.00
LE16/16/HA	1600	1600	710 - 890	£2557.00
LE18/16/HA	1800	1600	710 - 890	£2598.00

2 PERSON RECTANGULAR EXTENSION

	Dimensions			RRP
	W	D	H	
LE12/16/INT/HA	1200	1600	710 - 890	£2480.00
LE14/16/INT/HA	1400	1600	710 - 890	£2503.00
LE16/16/INT/HA	1600	1600	710 - 890	£2530.00
LE18/16/INT/HA	1800	1600	710 - 890	£2583.00

MADE TO ORDER MFC TOP FINISHES // FRAME FINISH



- Height adjustable 710 - 890mm via crank handle
- Complete with cable trays
- Sliding tops
- Top size is 10mm shorter than stated width to avoid fingers trapping when used in bench layout
- For matching storage and tables see pages 112 - 121



LINNEA ELEVATE - FIXED HEIGHT

5^{YR}
COMPONENT
GUARANTEE

25^{MM}
TOP
THICKNESS

MADE
TO
ORDER
20 DAYS



SINGLE RECTANGULAR

	Dimensions			RRP
	W	D	H	
LER12/8	1200	800	740	£715.00
LER14/8	1400	800	740	£728.00
LER16/8	1600	800	740	£740.00
LER18/8	1800	800	740	£755.00

SINGLE RECTANGULAR EXTENSION

	Dimensions			RRP
	W	D	H	
LER12/8/INT	1200	800	740	£715.00
LER14/8/INT	1400	800	740	£728.00
LER16/8/INT	1600	800	740	£740.00
LER18/8/INT	1800	800	740	£755.00

2 PERSON RECTANGULAR

	Dimensions			RRP
	W	D	H	
LE12/16	1200	1600	740	£1251.00
LE14/16	1400	1600	740	£1276.00
LE16/16	1600	1600	740	£1304.00
LE18/16	1800	1600	740	£1332.00

2 PERSON RECTANGULAR EXTENSION

	Dimensions			RRP
	W	D	H	
LE12/16/INT	1200	1600	740	£1224.00
LE14/16/INT	1400	1600	740	£1250.00
LE16/16/INT	1600	1600	740	£1276.00
LE18/16/INT	1800	1600	740	£1304.00

MADE TO ORDER MFC TOP FINISHES // FRAME FINISH



• For matching storage and tables see pages 112 - 121



LINNEA BENCH

5^{YR}
COMPONENT
GUARANTEE

25^{MM}
TOP
THICKNESS

MADE
TO
ORDER
20 DAYS



SINGLE BENCH

	Dimensions			RRP
	W	D	H	
LR10/8	1000	800	740	£559.00
LR12/8	1200	800	740	£568.00
LR14/8	1400	800	740	£576.00
LR16/8	1600	800	740	£583.00
LR18/8	1800	800	740	£593.00
LR20/8	2000	800	740	£602.00

SINGLE BENCH EXTENSION

	Dimensions			RRP
	W	D	H	
LR10/8/INT	1000	800	740	£520.00
LR12/8/INT	1200	800	740	£532.00
LR14/8/INT	1400	800	740	£542.00
LR16/8/INT	1600	800	740	£556.00
LR18/8/INT	1800	800	740	£566.00
LR20/8/INT	2000	800	740	£575.00

DOUBLE BENCH

	Dimensions			RRP
	W	D	H	
L10/16	1000	1600	740	£1016.00
L12/16	1200	1600	740	£1047.00
L14/16	1400	1600	740	£1078.00
L16/16	1600	1600	740	£1111.00
L18/16	1800	1600	740	£1141.00
L20/16	2000	1600	740	£1175.00

DOUBLE BENCH EXTENSION

	Dimensions			RRP
	W	D	H	
L10/16/INT	1000	1600	740	£974.00
L12/16/INT	1200	1600	740	£1005.00
L14/16/INT	1400	1600	740	£1038.00
L16/16/INT	1600	1600	740	£1067.00
L18/16/INT	1800	1600	740	£1101.00
L20/16/INT	2000	1600	740	£1133.00

MADE TO ORDER MFC TOP FINISHES // FRAME FINISH



- Complete with central cable tray
- Sliding top option is available call sales for details
- For matching storage and tables see pages 112 - 121
- For matching meeting tables see pages 104 - 105



LINNEA BENCH

5^{YR}
COMPONENT
GUARANTEE

25^{MM}
TOP
THICKNESS

MADE
TO
ORDER
20 DAYS



CURVED EXTENSION

	Dimensions			RRP
	W	D	H	
LCME12/5	1200	500	740	£549.00
LCME14/5	1400	500	740	£560.00
LCME16/6	1600	650	740	£570.00

STRAIGHT EXTENSION

	Dimensions			RRP
	W	D	H	
LSME12/5	1200	500	740	£549.00
LSME14/5	1400	500	740	£560.00
LSME16/6	1600	650	740	£570.00

• Other extensions available for compatibility with screens.
Ask sales for details

• Other extensions available for compatibility with screens.
Ask sales for details

CONFERENCE TABLE - TWO PIECE

	Seats	Dimensions			RRP
		W	D	H	
LCONF34	10	3400	1200	740	£1879.00
LCONF44	14	4400	1200	740	£2220.00

CONFERENCE TABLE - THREE PIECE

	Seats	Dimensions			RRP
		W	D	H	
LCONF48	16	4800	1200	740	£2489.00

MADE TO ORDER MFC TOP FINISHES // FRAME FINISH



MEETING TABLE

	Dimensions			RRP
	W	D	H	
LMT10/8	1000	800	740	£547.00
LMT12/8	1200	800	740	£559.00
LMT14/8	1400	800	740	£568.00
LMT16/8	1600	800	740	£583.00
LMT18/8	1800	800	740	£593.00
LMT20/8	2000	800	740	£602.00

CONFERENCE TABLE - ONE PIECE

	Seats	Dimensions			RRP
		W	D	H	
LCONF20	6	2000	1200	740	£1083.00
LCONF24	8	2400	1200	740	£1307.00

• Also available with 1000, 1200 and 1600mm depths. Ask sales for details



• Refer to trade price list. E&EO. All items are subject to VAT, where applicable.

LINNEA ACCESSORIES

5 YR
COMPONENT
GUARANTEE

MADE
TO
ORDER
20 DAYS

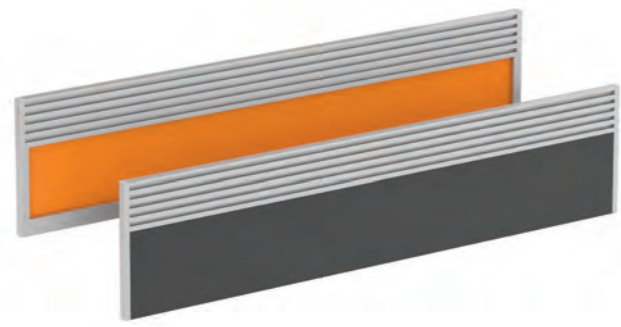
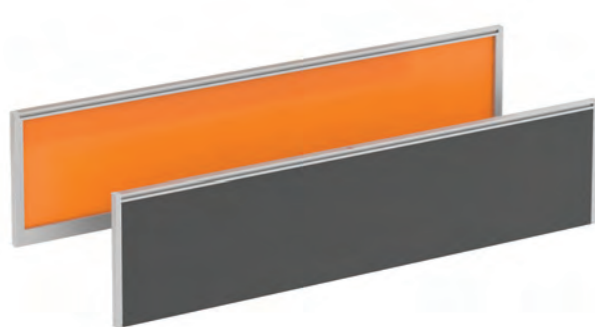

SINGLE BENCH SCREEN

	Dimensions			RRP
	W	D	H	
ESS12	1173	27	375	£288.00
ESS14	1373	27	375	£316.00
ESS16	1573	27	375	£340.00
ESS18	1773	27	375	£370.00

- Fabric: Fully upholstered pinnable surface with aluminium trim
- Only compatible with Linnea Bench

SINGLE BENCH SCREEN WITH MANAGEMENT RAIL

	Dimensions			RRP
	W	D	H	
ESS12M	1173	27	375	£374.00
ESS14M	1373	27	375	£401.00
ESS16M	1573	27	375	£456.00
ESS18M	1773	27	375	£493.00

- Fabric: Fully upholstered pinnable surface with aluminium trim
- Only compatible with Linnea Bench

FABRIC FINISH



- All screens priced in Camira Advantage fabric. Ask sales for details on other fabrics

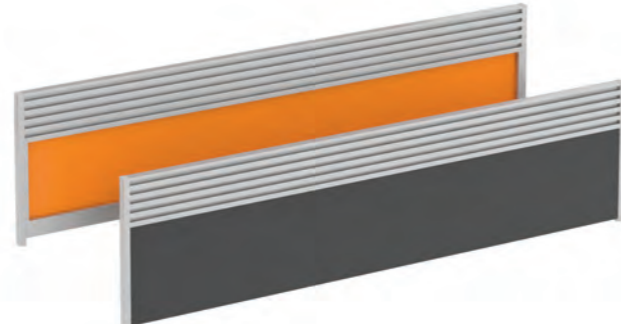
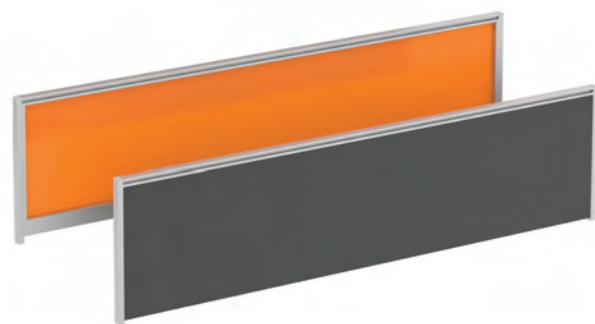

DOUBLE BENCH SCREEN

	Dimensions			RRP
	W	D	H	
LESS12	1173	27	375	£288.00
LESS14	1373	27	375	£316.00
LESS16	1573	27	375	£340.00
LESS18	1773	27	375	£370.00

- Fabric: Fully upholstered pinnable surface with aluminium trim
- Only compatible with Linnea Bench

DOUBLE BENCH SCREEN WITH MANAGEMENT RAIL

	Dimensions			RRP
	W	D	H	
LESS12M	1173	27	375	£374.00
LESS14M	1373	27	375	£401.00
LESS16M	1573	27	375	£456.00
LESS18M	1773	27	375	£493.00

- Fabric: Fully upholstered pinnable surface with aluminium trim
- Only compatible with Linnea Bench

• Refer to trade price list. E&EO. All items are subject to VAT, where applicable.



LINNEA CABLE TRAYS

	Dimensions			RRP
	W	D	H	
LRCT10	470	222	75	£72.00
LRCT12	670	222	75	£87.00
LRCT14	870	222	75	£95.00
LRCT16	1070	222	75	£111.00
LRCT18	1270	222	75	£126.00
LRCT20	1470	222	75	£139.00

- Cable trays can be accessed from front or back of desk via the easy slot and hook design

LINNEA MODESTY PANELS

	Dimensions		RRP
	W	H	
LRMP10	760	275	£139.00
LRMP12	960	275	£143.00
LRMP14	1160	275	£146.00
LRMP16	1360	275	£149.00
LRMP18	1560	275	£153.00
LRMP20	1760	275	£158.00

FINISHES



LINNEA CABLE RISERS

	RRP
LLCR	£40.00

- Single channel cable riser (2 pack)

OPTIMA PLUS HEIGHT ADJUSTABLE DESKS

5 YR
COMPONENT
GUARANTEE

25 MM
TOP
THICKNESS

MADE
TO
ORDER
20 DAYS



NOTE: Right hand shown



NOTE: Right hand shown

- Easy to use height adjustable crank handle
- Handle folds away neatly when not in use
- For matching storage and tables see pages 112 - 121

WAVE DESK

800 DEEP RECTANGULAR DESK

	Dimensions			RRP
	W	D	H	
OPR8/HA	800	800	650 - 850	£884.00
OPR10/HA	1000	800	650 - 850	£924.00
OPR12/HA	1200	800	650 - 850	£942.00
OPR14/HA	1400	800	650 - 850	£964.00
OPR16/HA	1600	800	650 - 850	£975.00
OPR18/HA	1800	800	650 - 850	£1000.00

		Dimensions			RRP
		W	D	H	
OPW12LH/HA	L/H	1200	800 / 1000	650 - 850	£1040.00
OPW14LH/HA	L/H	1400	800 / 1000	650 - 850	£1065.00
OPW16LH/HA	L/H	1600	800 / 1000	650 - 850	£1088.00
OPW18LH/HA	L/H	1800	800 / 1000	650 - 850	£1111.00
OPW12RH/HA	R/H	1200	800 / 1000	650 - 850	£1040.00
OPW14RH/HA	R/H	1400	800 / 1000	650 - 850	£1065.00
OPW16RH/HA	R/H	1600	800 / 1000	650 - 850	£1088.00
OPW18RH/HA	R/H	1800	800 / 1000	650 - 850	£1111.00

RADIAL DESK

		Dimensions			RRP
		W	D	H	
OPC14LH/HA	L/H	1400	800 / 1200	650 - 850	£1344.00
OPC16LH/HA	L/H	1600	800 / 1200	650 - 850	£1368.00
OPC18LH/HA	L/H	1800	800 / 1200	650 - 850	£1403.00
OPC14RH/HA	R/H	1400	800 / 1200	650 - 850	£1344.00
OPC16RH/HA	R/H	1600	800 / 1200	650 - 850	£1368.00
OPC18RH/HA	R/H	1800	800 / 1200	650 - 850	£1403.00

MADE TO ORDER MFC TOP FINISHES



FRAME FINISHES



OPTIMA PLUS

5 YR
COMPONENT
GUARANTEE

25 MM
TOP
THICKNESS

MADE
TO
ORDER
20 DAYS



NOTE: Right hand shown



NOTE: Right hand shown

• For matching storage and tables see pages 112 - 121

WAVE DESK

800 DEEP RECTANGULAR DESK

	Dimensions			RRP
	W	D	H	
OPR8	800	800	740	£418.00
OPR10	1000	800	740	£436.00
OPR12	1200	800	740	£453.00
OPR14	1400	800	740	£469.00
OPR16	1600	800	740	£481.00
OPR18	1800	800	740	£501.00

		Dimensions			RRP
		W	D	H	
OPW12LH	L/H	1200	800 / 1000	740	£536.00
OPW14LH	L/H	1400	800 / 1000	740	£563.00
OPW16LH	L/H	1600	800 / 1000	740	£582.00
OPW18LH	L/H	1800	800 / 1000	740	£600.00
OPW12RH	R/H	1200	800 / 1000	740	£536.00
OPW14RH	R/H	1400	800 / 1000	740	£563.00
OPW16RH	R/H	1600	800 / 1000	740	£582.00
OPW18RH	R/H	1800	800 / 1000	740	£600.00

CRESCENT DESK

		Dimensions			RRP
		W	D	H	
OPC14LH	L/H	1400	800 / 1200	740	£689.00
OPC16LH	L/H	1600	800 / 1200	740	£712.00
OPC18LH	L/H	1800	800 / 1200	740	£741.00
OPC14RH	R/H	1400	800 / 1200	740	£689.00
OPC16RH	R/H	1600	800 / 1200	740	£712.00
OPC18RH	R/H	1800	800 / 1200	740	£741.00

MADE TO ORDER MFC TOP FINISHES



FRAME FINISHES



LINNEA & OPTIMA PEDESTALS & FILING

5 YR
COMPONENT
GUARANTEE

MADE
TO
ORDER
20 DAYS



HIGH 3 DRAWER MOBILE PEDESTAL

	Dimensions			RRP
	W	D	H	
DMPF	420	600	640	£324.00

- 2 single drawers and 1 filing drawer
- Lockable, includes 2 keys

HIGH 4 DRAWER MOBILE PEDESTAL

	Dimensions			RRP
	W	D	H	
DMP4	420	600	640	£324.00

- 4 single drawers
- Lockable, includes 2 keys



NARROW MOBILE PEDESTAL

	Dimensions			RRP
	W	D	H	
DMPF/N	300	600	640	£307.00

- 2 single drawers and 1 filing drawer
- Lockable, includes 2 keys



DESK HIGH PEDESTALS

	Dimensions			RRP
	W	D	H	
DHPF	420	600	740	£341.00
DHPF/8	420	800	740	£449.00

- 2 single drawers and 1 filing drawer
- Lockable, includes 2 keys

MADE TO ORDER TOP FINISHES



LOW 2 DRAWER MOBILE PEDESTAL

	Dimensions			RRP
	W	D	H	
MPF - 2 DRAWER	420	600	480	£256.00

- 1 single drawers and 1 filing drawer
- Lockable, includes 2 keys

LOW 3 DRAWER MOBILE PEDESTAL

	Dimensions			RRP
	W	D	H	
MP3 - 3 DRAWER	420	600	480	£256.00

- 3 single drawers
- Lockable, includes 2 keys



FILING CABINETS

	Dimensions			RRP
	W	D	H	
FC2 - 2 DRAWER	468	600	740	£351.00
FC3 - 3 DRAWER	468	600	1075	£441.00
FC4 - 4 DRAWER	468	600	1400	£522.00

- Central locking with anti-tilt mechanism
- Lockable, includes 2 keys
- Foolscape filing

SIDE FILING UNITS

	Dimensions			RRP
	W	D	H	
NSF2/5	800	500	740	£649.00
NSF2/6	800	600	740	£685.00

- 2 filing drawers with built in anti-tilt mechanism
- Lockable, includes 2 keys
- Foolscape filing

• Refer to trade price list. E&EO. All items are subject to VAT, where applicable.

LINNEA & OPTIMA BOOKCASES

5 YR COMPONENT GUARANTEE
MADE TO ORDER
20 DAYS



MADE TO ORDER MFC TOP FINISHES // FRAME FINISH

A C B O W G GNO WE NNO WH // SF BGF WF
ASH AUTUMN CHERRY BEECH CHESTER OAK ENGLISH WALNUT GREY GREY NEBRASKA OAK LAURENTII WENGE NATURAL NEBRASKA OAK WHITE STANDARD SILVER BLACK GRAPHITE WHITE

- Wide range of colours available
- 18mm top and back panels
- All shelves fully adjustable



	Shelves	Dimensions			RRP
		W	D	H	
BS7	1	800	300	740	£216.00
BS10	2	800	300	1000	£239.00
BS12	3	800	300	1200	£291.00
BS16	4	800	300	1600	£311.00
BS18	4	800	300	1800	£325.00
BS20	5	800	300	2000	£397.00

• Refer to trade price list. E&EO. All items are subject to VAT, where applicable.

LINNEA & OPTIMA CUPBOARDS

5 YR COMPONENT GUARANTEE
MADE TO ORDER
20 DAYS



MADE TO ORDER MFC TOP FINISHES // FRAME FINISH

A C B O W G GNO WE NNO WH // SF BGF WF
ASH AUTUMN CHERRY BEECH CHESTER OAK ENGLISH WALNUT GREY GREY NEBRASKA OAK LAURENTII WENGE NATURAL NEBRASKA OAK WHITE STANDARD SILVER BLACK GRAPHITE WHITE

- 18mm top and back panels
- All shelves fully adjustable
- Optional handle styles available, call sales for details



	Shelves	Dimensions			RRP
		W	D	H	
SC12	2	800	400	1200	£458.00
SC16	3	800	400	1600	£522.00
SC18	3	800	400	1800	£585.00
SC20	4	800	400	2000	£650.00
25mm TOP PANEL					
SC7 - Including 1 shelf	1	800	400	740	£407.00

OPTIMA TAMBOURS

5 YR COMPONENT GUARANTEE
MADE TO ORDER
20 DAYS



MADE TO ORDER MFC TOP FINISHES // FRAME FINISH

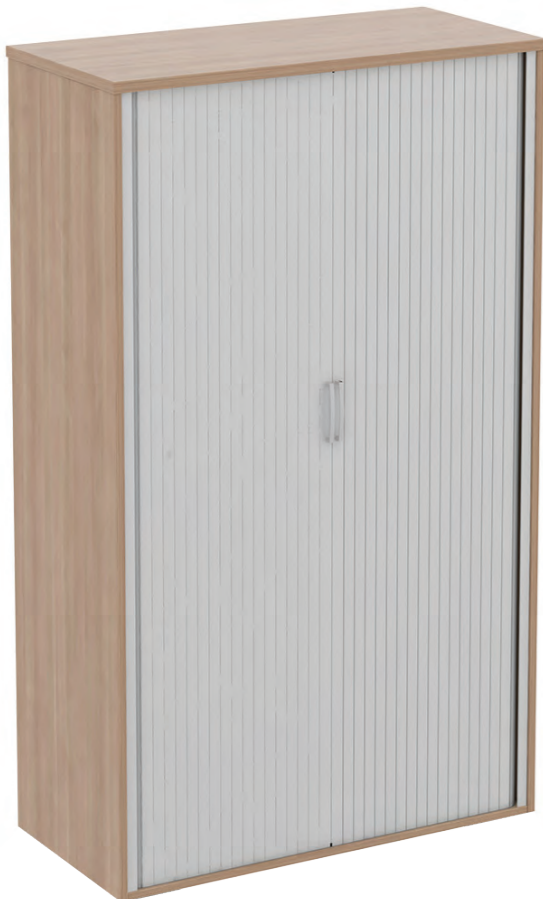

- Complete with system storage unit skins
- Supplied in silver as standard. For white tambour door, suffix code with /WH
- Supplied empty, see page 117 for internal fittings

	Dimensions			RRP
	W	D	H	
NSSC7ST	1050	500	740	£732.00
NSSC12ST	1050	500	1200	£861.00
NSSC16ST	1050	500	1600	£927.00
NSSC18ST	1050	500	1800	£1023.00
NSSC20ST	1050	500	2000	£1121.00

STORAGE UNITS

5 YR COMPONENT GUARANTEE
MADE TO ORDER
20 DAYS



DESK HIGH STORAGE UNITS

	Dimensions			RRP
	W	D	H	
NSU8/4	800	400	740	£384.00
NSU12/4	1200	400	740	£495.00
NSU16/4	1600	400	740	£603.00

TOP STORAGE UNIT

	Dimensions			RRP
	W	D	H	
TCG8H	800	350	860bv	£498.00

INTERNAL STORAGE ACCESSORIES

SLOTTED FILING SHELF	RRP
BIT10SSPDPS - Shelf	£57.00
SHDV85P5P5 - 5 x Dividers	£62.00

LATERAL FILING CRADLE	RRP
Adjustable lateral filing cradle, between 250 & 350mm centres	
BIT10LRPS - 1 Shelf	£45.00

PULL OUT VERTICAL FILING CRADLE	RRP
Two cross bars to accept foolscap filing side on. Foolscap front to back	
A4 front to back	
BIT10RFAPS	£127.00

STANDARD SHELF	RRP
BIT10BSPS - 1 Shelf	£34.00

PULL OUT REFERENCE SHELF	RRP
System storage unit skins are required for this shelf	
BIT10RSPS	£120.00

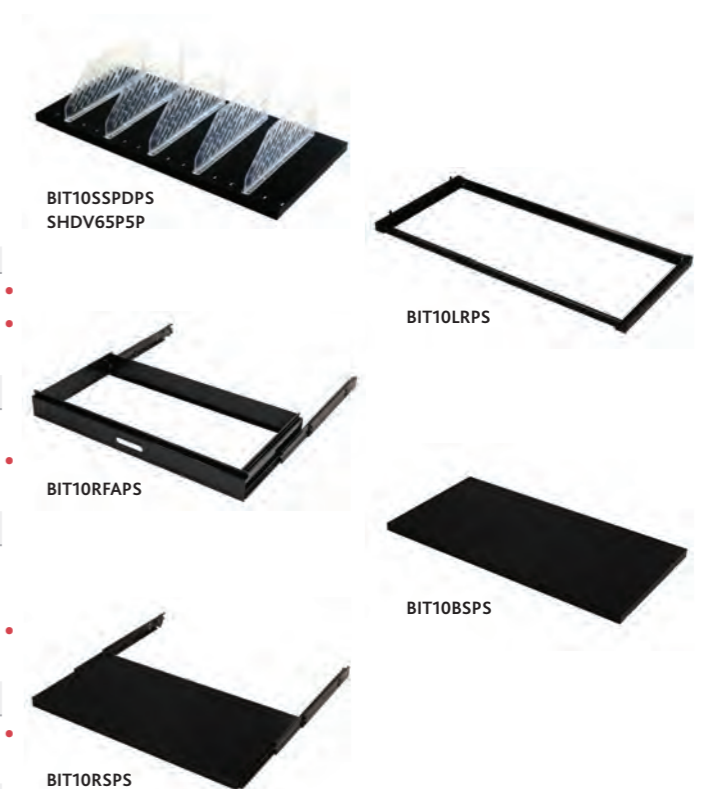

OPTIMA PLUS MEETING TABLES

5 YR
COMPONENT
GUARANTEE

MADE
TO
ORDER
20 DAYS



RECTANGULAR MEETING TABLE

	Dimensions			RRP
	W	D	H	
OPRMT12	1200	800	740	£485.00
OPRMT14	1400	800	740	£503.00
OPRMT16	1600	800	740	£516.00
OPRMT18	1800	800	740	£532.00

DOUBLE D ENDED MEETING TABLE

	Dimensions			RRP
	W	D	H	
OPDDMT20	2000	800	740	£721.00
OPDDMT22	2200	800	740	£740.00
OPDDMT24	2400	800	740	£752.00
OPDDMT26	2600	800	740	£769.00

MEETING EXTENSION - ROUND LEG

	Dimensions			RRP
	W	D	H	
OPDWSCMT18	1800	800	740	£703.00

- Complete with 120mm diameter support leg on 300mm diameter base
- Suitable for 1800mm wide double wave desking

MEETING EXTENSION - DOUBLE LEG

	Dimensions			RRP
	W	D	H	
OPDWSCMT	2000	800	740	£716.00

- Complete with 2 x 60mm diameter support legs
- Suitable for 2000mm wide double wave desking

MADE TO ORDER MFC TOP FINISHES // FRAME FINISH



OPTIMA PLUS CONFERENCE TABLES

5 YR
COMPONENT
GUARANTEE

MADE
TO
ORDER
20 DAYS



DOUBLE ENDED CONFERENCE TABLE

	Dimensions			RRP
	W	D	H	
OPCONF1CA	2000	1200	740	£878.00
OPCONF1CB	2400	1200	740	£1051.00

- 120mm diameter legs on 685mm diameter base
- Seating up to 8 people

PLUS RECTANGULAR CONFERENCE TABLES

	Dimensions			RRP
	W	D	H	
OPCONF1SA	2000	1200	740	£878.00
OPCONF1SB	2400	1200	740	£1051.00

- 120mm diameter legs on 685mm diameter base
- Seating up to 8 people

DOUBLE D ENDED CONFERENCE TABLES

	Sections	Dimensions			RRP
		W	D	H	
OPCONF1A	1	2000	1200	740	£878.00
OPCONF2	2	3400	1200	740	£1753.00
OPCONF3	3	4800	1200	740	£2239.00

- 'I' frame leg configuration with modesty panel
- OPCONF1A supplied with 1 x 1320mm underframe. Seats up to 8 people
- OPCONF2 supplied in 2 x 1700mm sections with 2 x 1320mm underframes. Seats up to 10 people
- OPCONF3 supplied in 2 x 1700mm sections and 1 x 1400mm centre section with 3 x 1320mm underframes. Seats up to 14 people

MADE TO ORDER MFC TOP FINISHES // FRAME FINISH



EXECUTIVE DESKING

// 08

Need something a little fancier? You'll find it here. This range is designed to add a touch of high end to your office without compromising on comfort or style.



CONTENTS

- 124 E-Space
- 128 Regent
- 130 Regent Bookcases & Cupboards

5YR
COMPONENT
GUARANTEE

36MM
TOP
THICKNESS

E SPACE



* Right hand desk shown



* Left hand desk shown



* Left hand desk shown

- Hard wearing MFC in cappuccino wood finish
- Left and right hand desk options
- 36mm top and 50mm wide leg panels
- Brushed aluminium handles
- Lockable drawers
- Pedestals include a pen tray drawer



DESK

		Dimensions			RRP
		W	D	H	
ES605CAP	R/H	2200	1190	750	£567.00
ES604CAP	L/H	2200	1190	750	£567.00

2 DRAWER PEDESTAL DESK

		Dimensions			RRP
		W	D	H	
ES600CAP	R/H	2200	1190	750	£764.00
ES602CAP	L/H	2200	1190	750	£764.00

3 DRAWER PEDESTAL DESK

		Dimensions			RRP
		W	D	H	
ES601CAP	R/H	2200	1190	750	£734.00
ES603CAP	L/H	2200	1190	750	£734.00

TOP FINISH // FRAME FINISH



Features Pallas executive chair, Milan skid chairs & Moonstone sofa

E SPACE

5 YR
COMPONENT
GUARANTEE

36 MM
TOP
THICKNESS



RETURN 2 DRAWER

	Dimensions			RRP
	W	D	H	
ES606CAP	1380	480	700	£469.00

RETURN 3 DRAWER

	Dimensions			RRP
	W	D	H	
ES607CAP	1380	480	700	£440.00



CIRCULAR MEETING TABLE

	Dimensions			RRP
	W	D	H	
ES609CAP	1200	1200	750	£441.00



BARREL SHAPED TABLE

	Dimensions			RRP
	W	D	H	
ES608CAP	2200	1000	750	£541.00



2 DRAWER MOBILE PEDESTAL

	Dimensions			RRP
	W	D	H	
ES622CAP	406	550	640	£256.00



3 DRAWER MOBILE PEDESTAL

	Dimensions			RRP
	W	D	H	
ES621CAP	406	550	640	£235.00



HIGH STORAGE CABINET

	Shelves	Dimensions			RRP
		W	D	H	
ES624CAP	3	806	425	1900	£571.00



HIGH STORAGE CABINET WITH GLASS DOORS

	Shelves	Dimensions			RRP
		W	D	H	
ES625CAP	3	806	425	1900	£809.00



LOW CABINET

	Shelves	Dimensions			RRP
		W	D	H	
ES626CAP	1	806	425	825	£283.00



- Hard wearing MFC in cappuccino wood finish
- Brushed aluminium handles
- Pedestals include a pen tray drawer
- Lockable

REGENT

5 YR
COMPONENT
GUARANTEE

36 MM
TOP
THICKNESS



BOW FRONTED EXECUTIVE DESK

TR2090	Dimensions			RRP
	W	D	H	
	2000	900	750	£553.00

RECTANGULAR EXECUTIVE DESK

TR1890	Dimensions			RRP
	W	D	H	
	1800	900	750	£503.00

SIDE RETURN

TR1060	Dimensions			RRP
	W	D	H	
	1000	600	750	£252.00

UNDER DESK PEDESTAL

TRUDP3	Dimensions			RRP
	W	D	H	
	435	565	700	£402.00

// NOTE: Fits both left & right sides of desk

FINISHES



MEETING TABLE

TR1200MT	Dimensions			RRP
	W	D	H	
	1200	1200	750	£377.00

BOARDROOM TABLE

TR1810BT	Dimensions			RRP
	W	D	H	
	1800	1150	750	£483.00
TR2410BT	2400	1250	750	£603.00

REGENT BOOKCASES & CUPBOARDS

5YR COMPONENT GUARANTEE

36MM TOP THICKNESS

FIXED SHELF



FINISHES

DW NO

DARK WALNUT NOVA OAK

- Part of our Regent range with premium wood finishes and chrome detailing
- Chrome glide feet for a stylish look

		Shelves	Dimensions			RRP
			W	D	H	
TR8040	Bookcase	1	1005	404	800	£302.00
TR1640	Bookcase	3	1005	404	1560	£503.00
TR8040CP	Cupboard	1	1005	404	800	£428.00
TR1640CP	Cupboard	3	1005	404	1560	£704.00



REGENT TALL GLASS CUPBOARD

5YR COMPONENT GUARANTEE

36MM TOP THICKNESS

RECTANGULAR



FINISHES

DW NO

DARK WALNUT NOVA OAK

- Part of our Regent range with premium wood finishes and chrome detailing
- A tall cupboard with split frosted glass doors in dark walnut or nova oak
- Chrome adjustable feet to avoid marking floors

	Shelves	Dimensions			RRP
		W	D	H	
TR1640GCP	3	1005	404	1560	£855.00



MEETING TABLES

// 09

While you're not always in control of the agenda at meetings, you can be in control of what you choose to sit at during them. The style needn't be compromised for comfort with this range of product, nor should space constrictions; as we've included products that make flexible meeting spaces easy.

CONTENTS

134	Plateau	148	Union Folding Tables
136	Plateau High	150	One Tables
138	Meeting Tables	151	Contract Blocks
140	Reflex	152	Picnic
141	Lux	154	Modular Tables
142	Windsor	155	Summit
143	Aerofoil	156	Start 18 Multipurpose
144	Fraction Infinity Tables	158	Contract Tables
146	Tilting Tables	160	Coffee Tables
147	Economy Tilting Tables		

PLATEAU

5YR COMPONENT GUARANTEE
25MM TOP THICKNESS
DELIVERY & INSTALLATION ONLY
28 DAYS



ROUND MEETING TABLE

	Dimensions			RRP
	W	D	H	
ZPLA1200D	1200	1200	740	£727.00
ZPLA1400D	1400	1400	740	£773.00



SQUARE MEETING TABLE

	Dimensions			RRP
	W	D	H	
ZPLA1414S	1400	1400	740	£952.00
ZPLA1616S	1600	1600	740	£1012.00



RECTANGULAR MEETING TABLE

	Dimensions			RRP
	W	D	H	
ZPLA1680R	1600	800	740	£881.00
ZPLA1890R	1800	900	740	£921.00
ZPLA2010R	2000	1000	740	£967.00
ZPLA2210R	2200	1000	740	£986.00
ZPLA2412R	2400	1200	740	£1088.00
ZPLA2814R	2800	1400	740	£1555.00



BARREL MEETING TABLE

	Dimensions			RRP
	W	D	H	
ZPLA2010B	2000	1000	740	£981.00
ZPLA2412B	2400	1200	740	£1102.00



LOW STOOL

		Dimensions			RRP
		W	D	H	
SPS-LSTL	Plain top	375	375	500	£408.00
SPS-LSTL-BTN	Button Top	375	375	500	£413.00



BENCH

		Dimensions			RRP
		W	D	H	
SP-SPS-N	Plain top	1180	375	500	£684.00
SP-BEN-N	Button top	1180	375	500	£721.00

TOP FINISHES // FRAME FINISH



FABRIC FINISH



// NOTE: Priced in Camira Rivet

E&EO. All items are subject to VAT, where applicable.



PLATEAU HIGH



5YR
COMPONENT
GUARANTEE

25MM
TOP
THICKNESS

DELIVERY &
INSTALLATION
ONLY
28 DAYS



HIGH TABLE

	Dimensions			RRP
	W	D	H	
ZPLAP1410R	1400	1000	830	£1206.00
ZPLAP1610R	1600	1000	830	£1257.00
ZPLAP1810R	1800	1000	830	£1307.00
ZPLAP2010R	2000	1000	830	£1357.00
ZPLAP2210R	2200	1000	830	£1407.00
ZPLAP2410R	2400	1000	830	£1458.00

HIGH STOOL

		Dimensions			RRP
		W	D	H	
SP-SPS-HSTL	Plain	375	375	830	£603.00
SP-SPS-HSTL-BTN	Button	375	375	830	£614.00

TOP FINISHES // FRAME FINISH



FABRIC FINISH



// NOTE: Priced in Camira Rivet



MEETING TABLES

5 YR
COMPONENT
GUARANTEE

MADE
TO
ORDER
25 DAYS



ALTO HIGH BENCH

	Dimensions			RRP
	W	D	H	
AB22/12	2200	1200	1050	£1323.00
AB24/12	2400	1200	1050	£1385.00
AB26/12	2600	1200	1050	£1449.00
AB28/12	2800	1200	1050	£1511.00
AB30/12	3000	1200	1050	£1574.00

HARMONY HIGH BENCH

	Dimensions			RRP
	W	D	H	
HB14/9	1400	900	1050	£685.00
HB16/9	1600	900	1050	£712.00
HB18/9	1800	900	1050	£739.00
HB20/9*	2000	900	1050	£767.00

* Model includes support frame



LOCO BENCH

	Dimensions			RRP
	W	D	H	
LB14/8	1400	800	740	£602.00
LB16/8	1600	800	740	£630.00
LB18/8	1800	800	740	£658.00
LB20/8	2000	800	740	£685.00

MFC TOP FINISHES



FRAME FINISHES



FABRIC FINISH



LOCO SEAT

	Dimensions			RRP
	W	D	H	
LBS13	1300	330	450	£455.00
LBS15	1500	330	450	£477.00
LBS17	1700	330	450	£499.00
LBS19	1900	330	450	£520.00

LOCO SEAT PADS

		Dimensions			RRP
		W	D	H	
FSP13	Full length seat pad	1300	330	450	£170.00
FSP15	Full length seat pad	1500	330	450	£188.00
FSP17	Full length seat pad	1700	330	450	£198.00
FSP19	Full length seat pad	1900	330	450	£212.00
ISP13	3 individual seat pads	1300	330	450	£177.00
ISP15	3 individual seat pads	1500	330	450	£195.00
ISP17	3 individual seat pads	1700	330	450	£209.00
ISP19	3 individual seat pads	1900	330	450	£219.00

• Refer to trade price list. E&EO. All items are subject to VAT, where applicable.



5 YR
COMPONENT
GUARANTEE

MADE
TO
ORDER
25 DAYS

REFLEX



ONE PIECE OCTAGONAL CONFERENCE TABLE

	Dimensions			RRP
	W	D	H	
ROCT2400	2400	1000	740	£1823.00
ROCT2600	2600	1200	740	£1882.00
ROCT2800	2800	1200	740	£1958.00
ROCT3000	3000	1400	740	£2824.00

• ROCT3000 features a shared cable tray

ONE PIECE RECTANGULAR MEETING TABLE

	Dimensions			RRP
	W	D	H	
RMT16/10	1600	1000	740	£1257.00
RMT18/10	1800	1000	740	£1380.00
RMT20/12	2000	1200	740	£1558.00
RMT22/12	2200	1200	740	£1684.00
RMT24/12	2400	1200	740	£1808.00
RMT26/14	2600	1400	740	£1925.00
RMT28/14	2800	1400	740	£1986.00



- Tapered angled legs with steel subframe
- Adjustable levelling feet
- Supplied with horizontal three channel cable management when ordered with a power module. See Page 143

TWO PIECE RECTANGULAR MEETING TABLE

	Dimensions			RRP
	W	D	H	
RMT30/14	3000	1400	740	£2659.00
RMT32/14	3200	1400	740	£2715.00
RMT36/14	3600	1400	740	£2826.00
RMT40/14	4000	1400	740	£2936.00
RMT44/14	4400	1400	740	£3047.00
RMT48/14	4800	1400	740	£3156.00

• Shared centre leg

MFC FINISHES



FRAME FINISHES



• Refer to trade price list. E&EO. All items are subject to VAT, where applicable.

5 YR
COMPONENT
GUARANTEE

MADE
TO
ORDER
25 DAYS

LUX



1000 DEEP RECTANGULAR MEETING TABLE

	Dimensions			RRP
	W	D	H	
LUXMT12/10	1200	1000	725	£1145.00
LUXMT14/10	1400	1000	725	£1201.00
LUXMT16/10	1600	1000	725	£1258.00
LUXMT18/10	1800	1000	725	£1380.00
LUXMT20/10	2000	1000	725	£1505.00
LUXMT22/10	2200	1000	725	£1628.00
LUXMT24/10	2400	1000	725	£1752.00
LUXMT26/10	2600	1000	725	£1814.00
LUXMT28/10	2800	1000	725	£1877.00

1200 DEEP OCTAGONAL CONFERENCE TABLE

	Dimensions			RRP
	W	D	H	
LUXOCT2600	2600	1200	725	£1882.00
LUXOCT2800	2800	1200	725	£1958.00



- Tapered oak angled legs as standard
- Steel sub frame
- Adjustable levelling feet
- Supplied with horizontal three channel cable management when ordered with a power module. See page 143

1400 DEEP RECTANGULAR MEETING TABLE

	Dimensions			RRP
	W	D	H	
LUXMT16/14	1600	1400	725	£1366.00
LUXMT18/14	1800	1400	725	£1490.00
LUXMT20/14	2000	1400	725	£1617.00
LUXMT22/14	2200	1400	725	£1738.00
LUXMT24/14	2400	1400	725	£1863.00
LUXMT26/14	2600	1400	725	£1925.00
LUXMT28/14	2800	1400	725	£1986.00

MFC FINISHES



FRAME FINISHES

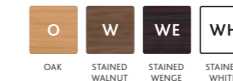

WINDSOR

- Gives a distinct and traditional appeal to any meeting or boardroom
- Hand finished
- MFC Finishes: Ash, Autumn Cherry, Beech, Chester Oak, English Walnut, Grey, Grey Nebraska Oak, Laurentii Wenge, Natural Nebraska Oak, White

5 YR
COMPONENT
GUARANTEE

**MADE
TO
ORDER**
25 DAYS



OVAL CONFERENCE TABLE

	Dimensions			RRP
	W	D	H	
OVT24	2400	1200	740	£1298.00

- Arrowhead leg base with modesty panel. Seating up to 8 people



DOUBLE D ENDED CONFERENCE TABLE

	Dimensions			RRP
	W	D	H	
DDT24	2400	1200	740	£1298.00

- Arrowhead leg base with modesty panel. Seating up to 8 people



BARREL CONFERENCE TABLE

	Dimensions			RRP
	W	D	H	
BST24	2400	1200	740	£1298.00

- Arrowhead leg base with modesty panel. Seating up to 8 people



DOUBLE D ENDED CONFERENCE TABLE

	Dimensions			RRP
	W	D	H	
CONF2AL	3400	1200	740	£1849.00

- Arrowhead leg base with modesty panel. Seating up to 10 people
- Supplied in 2 x 1700mm sections

MFC FINISHES



• Refer to trade price list. E&EO. All items are subject to VAT, where applicable.

AEROFOIL

- A beautiful yet practical solution to your meeting room
- Optional power modules can be incorporated
- MFC Finishes: Ash, Autumn Cherry, Beech, Chester Oak, English Walnut, Grey, Grey Nebraska Oak, Laurentii Wenge, Natural Nebraska Oak, White
- Metalwork Finishes: Silver, Black Graphite, White

5 YR
COMPONENT
GUARANTEE

1 YR
GUARANTEE
ON ELECTRICAL
ITEMS

**MADE
TO
ORDER**
25 DAYS



BARREL SHAPED BOARDROOM TABLE

	Dimensions			RRP
	W	D	H	
ABT26	2600	1300	740	£2111.00
ABT28	2800	1300	740	£2186.00

- Barrel shaped top with elliptical base with silver extruded upright
- Horizontal & vertical cable management. Seating up to 8 people



BARREL SHAPED BOARDROOM TABLE

	Dimensions			RRP
	W	D	H	
ABT40	4000	1300	740	£3229.00

- Barrel shaped top with elliptical base with silver extruded upright
- Horizontal & vertical cable management
- Seating up to 12 people. Supplied in 2 x 2000mm sections

MFC FINISHES // METAL FINISHES



POWER MODULE TYPE 1

	RRP
PPM2/S	£262.00
PPM2/B	£337.00
PPM2/W	£337.00

- 2 x Power sockets, 3.15 Amps individually fused
- Available in black, silver & white



POWER MODULE TYPE 2

	RRP
PPM4/S	£359.00
PPM4/B	£475.00
PPM4/W	£475.00

- 4 x Power sockets, 3.15 Amps individually fused
- Available in black, silver & white



POWER & DATA MODULE TYPE 1

	RRP
PPMD2/S	£352.00
PPMD2/B	£424.00
PPMD2/W	£428.00

- 2 x Power sockets, 3.15 Amps individually fused & 2 x Cat5e data sockets
- Includes 3 metre data cable
- Available in black, silver & white



POWER & DATA MODULE TYPE 2

	RRP
PPMD4/S	£432.00
PPMD4/B	£549.00
PPMD4/W	£549.00

- 4 x Power sockets, 3.15 Amps individually fused & 2 x Cat5e data sockets
- Includes 3 metre data cable
- Available in black, silver & white



POWER & DATA MODULE COLOURS



- Silver with Grey trim / S (Standard lead time)
- Black with Black trim / B (4 week lead time)
- White with Grey trim / W (4 week lead time)

MAINS CABLE - BLACK PLUG

	Length	RRP
3M	3000	£18.00
5M	5000	£22.00
7M	7000	£27.00



FRACTION INFINITY TABLES

5^{YR}
COMPONENT
GUARANTEE

25^{MM}
TOP
THICKNESS



- A modern twist on the traditional 4 leg table
- Intermediate legs facilitate larger tables to support teams working together or collaborative spaces
- There are an infinite amount of configurations and sizes, please speak to our sales team for further information

SQUARE MEETING TABLES

	Dimensions			RRP
	W	D	H	
ZFIMT1212	1200	1200	740	£404.00
ZFIMT1414	1400	1400	740	£449.00
ZFIMT1616	1600	1600	740	£510.00

RECTANGULAR MEETING TABLES

	Dimensions			RRP
	W	D	H	
ZFIMT1408	1400	800	740	£333.00
ZFIMT1608	1600	800	740	£354.00
ZFIMT1808	1800	800	740	£364.00
ZFIMT2010	2000	1000	740	£476.00
ZFIMT2412	2400	1200	740	£601.00

TOP FINISHES // FRAME FINISHES

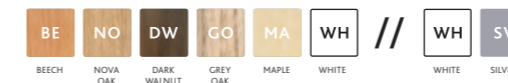

5^{YR}
COMPONENT
GUARANTEE

25^{MM}
TOP
THICKNESS

TILTING TABLES



D-END

	Dimensions			RRP
	W	D	H	
OTT1470DEND	1400	700	720	£573.00
OTT1680DEND	1600	800	720	£584.00

TRAPEZOIDAL

	Dimensions			RRP
	W	D	H	
OTT1470TRAP	1400	700	720	£573.00
OTT1680TRAP	1600	800	720	£584.00



- A mobile table with a user friendly quick release bar to tilt top
- Available with a silver frame
- Can be stacked or nested
- Ideal for multi-functional rooms where space is at a premium
- Lockable castors

RECTANGULAR

	Dimensions			RRP
	W	D	H	
OTT1270	1200	700	720	£563.00
OTT1280	1200	800	720	£565.00
OTT1470	1400	700	720	£573.00
OTT1480	1400	800	720	£575.00
OTT1670	1600	700	720	£584.00
OTT1680	1600	800	720	£587.00
OTT1880	1800	800	720	£598.00

TOP FINISHES // FRAME FINISH



5^{YR}
COMPONENT
GUARANTEE

25^{MM}
TOP
THICKNESS

ECONOMY TILTING TABLES



ECONOMY D-END

	Dimensions			RRP
	W	D	H	
OETT1470DEND	1400	700	720	£337.00
OETT1680DEND	1600	800	720	£362.00

ECONOMY TRAPEZOIDAL

	Dimensions			RRP
	W	D	H	
OETT1680TRAP	1600	800	720	£362.00

- Only order with 800 depth Rectangular



- A mobile table with manual adjustment thumb wheels to tilt top
- Available with a silver frame
- Can be stacked or nested
- Ideal for multi-functional rooms where space is at a premium
- Lockable castors

ECONOMY RECTANGULAR

	Dimensions			RRP
	W	D	H	
OETT1270	1200	700	720	£311.00
OETT1280	1200	800	720	£311.00
OETT1470	1400	700	720	£337.00
OETT1480	1400	800	720	£337.00
OETT1670	1600	700	720	£362.00
OETT1680	1600	800	720	£362.00

TOP FINISHES // FRAME FINISH



5^{YR}
COMPONENT
GUARANTEE

25^{MM}
TOP
THICKNESS

UNION FOLDING TABLES



RECTANGULAR

	Dimensions			RRP	
	W	D	H	SILVER	CHROME
OUFT1270	1200	700	725	£322.00	£332.00
OUFT1280	1200	800	725	£322.00	£332.00
OUFT1470	1400	700	725	£342.00	£352.00
OUFT1480	1400	800	725	£342.00	£352.00
OUFT1670	1600	700	725	£352.00	£362.00
OUFT1680	1600	800	725	£352.00	£362.00



TRAPEZOIDAL

	Dimensions			RRP	
	W	D	H	SILVER	CHROME
OUFT1680TRAP	1600	800	725	£382.00	£392.00



D-END

	Dimensions			RRP	
	W	D	H	SILVER	CHROME
OUFT1680DEND	1600	800	725	£382.00	£392.00

- Fold flat legs for easy storage
- Chrome and silver leg options
- Ideal for multifunctional rooms where space is at a premium

TOP FINISHES // FRAME FINISHES

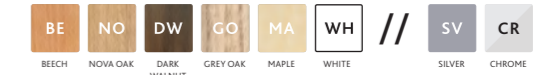

5^{YR}
COMPONENT
GUARANTEE

25^{MM}
TOP
THICKNESS

ONE TABLE



RECTANGULAR

	Dimensions			RRP
	W	D	H	
OFPMT1280	1200	800	730	£201.00
OFPMT1480	1400	800	730	£222.00
OFPMT1680	1600	800	730	£242.00
OFPMT1880	1800	800	730	£262.00

CIRCULAR

	Dimensions			RRP
	W	D	H	
OFPMT10D	1000	1000	730	£209.00
OFPMT12D	1200	1200	730	£229.00



BOARDROOM TABLE 1800

	Dimensions			RRP
	W	D	H	
OFPBD1800	1800	1200	730	£260.00

BOARDROOM TABLE 2400

	Dimensions			RRP
	W	D	H	
OFPBD2400	2400	1200	730	£337.00

TOP FINISHES // FRAME FINISH



ROUND MEETING TABLE

	Dimensions			RRP
	W	D	H	
TES1100D	1100	1100	730	£260.00

D-END MEETING TABLE

	Dimensions			RRP
	W	D	H	
TK1810DE	1800	1000	730	£549.00
TK2412DE	2400	1200	730	£658.00
OFPBT2400	2400	1200	730	£463.00

FINISHES



5^{YR}
COMPONENT
GUARANTEE

25^{MM}
TOP
THICKNESS

CONTRACT BLOCKS



CONTRACT BLOCK SQUARE

	Dimensions			RRP
	W	D	H	
CH2697	1000	1000	725	£347.00

CONTRACT BLOCK SEMI

	Dimensions			RRP
	W	D	H	
CH2696	1000	1000	725	£319.00

TOP FINISHES // FRAME FINISH

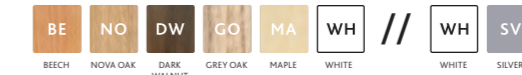

PICNIC

5 YR
COMPONENT
GUARANTEE

25^{MM}
TOP
THICKNESS

MADE
TO
ORDER
28 DAYS



- 25mm top thickness
- Heavy duty frame (KD)
- Two table height options available

BENCH

	Dimensions			RRP
	W	D	H	
PCB1435 (FITS 1600 LOW TABLE)	1400	350	410	£429.00
PCB1635 (FITS 1800 LOW TABLE)	1600	350	410	£450.00
PCB1835 (FITS 2000 LOW TABLE)	1800	350	410	£462.00

LOW TABLE

	Dimensions			RRP
	W	D	H	
PCTL1680	1600	800	740	£592.00
PCTL1880	1800	800	740	£603.00
PCTL2000	2000	800	740	£691.00

HIGH TABLE

	Dimensions			RRP
	W	D	H	
PCTH1680	1600	800	1100	£647.00
PCTH1880	1800	800	1100	£658.00
PCTH2000	2000	800	1100	£734.00

TOP FINISHES // FRAME FINISHES



MODULAR TABLES

5YR COMPONENT GUARANTEE
25MM TOP THICKNESS
MADE TO ORDER
25 DAYS



RECTANGULAR

	Dimensions			RRP MFC
	W	D	H	
TR8	800	800	740	£267.00
TR10	1000	800	740	£278.00
TR12	1200	800	740	£292.00
TR14	1400	800	740	£317.00
TR16	1600	800	740	£340.00
TR18	1800	800	740	£366.00

SEMI CIRCULAR

	Dimensions			RRP MFC
	W	D	H	
TSC16	1600	690	740	£552.00



TRAPEZOIDAL

	Dimensions			RRP MFC
	W	D	H	
TT14	1400	690	740	£506.00
TT16	1600	690	740	£552.00

- Configurable training and conference room furniture
- MFC top with welded underframe
- 40mm diameter tubular legs

Edging Finishes	RRP
White with Black	POA
White with Laurenti Wegne	POA
White with Plywood Effect	POA

MFC FINISHES

A	C	B	O	W	G	GNO	WE	NNO	WH
ASH	AUTUMN CHERRY	BEECH	CHESTER OAK	ENGLISH WALNUT	GREY	GREY NEBRASKA OAK	LAURENTI WENGE	NATURAL NEBRASKA OAK	WHITE

FRAME FINISHES

SF	BGF	WF
SILVER	BLACK GRAPHITE	WHITE



SUMMIT

5YR COMPONENT GUARANTEE
25MM TOP THICKNESS



RECTANGULAR DESK

	Dimensions			RRP
	W	D	H	
TSMT1680REC	1600	800	730	£315.00

SEMI-CIRCULAR DESK

	Dimensions			RRP
	W	D	H	
TSMT80DSEM	1600	800	730	£343.00

TOP FINISHES // FRAME FINISH

BE	NO	DW	GO	MA	WH	//	CR
BEECH	NOVA OAK	DARK WALNUT	GREY OAK	MAPLE	WHITE		CHROME



START 18 MULTIPURPOSE

5YR
COMPONENT
GUARANTEE

18MM
TOP
THICKNESS



- A range of tables in four different shapes to enable you to make the best use of your space
- Flatpack frame construction
- Ideal for constructing meeting or boardroom tables of different shapes

RECTANGULAR DESK

	Dimensions			RRP
	W	D	H	
OMPT1280REC	1200	800	730	£134.00
OMPT1680REC	1600	800	730	£144.00
OMPT1880REC	1800	800	730	£150.00

SEMI-CIRCULAR DESK

	Dimensions			RRP
	W	D	H	
OMPT1680SEMI	1600	800	730	£254.00

TRAPEZOIDAL DESK

	Dimensions			RRP
	W	D	H	
OMPT1680TRAP	1600	692	730	£254.00

TOP FINISHES // FRAME FINISHES

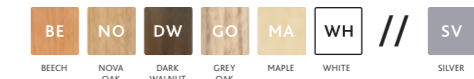

CONTRACT TABLES

5^{YR}
COMPONENT
GUARANTEE

25^{MM}
TOP
THICKNESS



LOW TABLE

	Dimensions			RRP
	W	D	H	
CH2683	600	600	430	£276.00
CH2693	800	800	430	£330.00

MEDIUM TABLE

	Dimensions			RRP
	W	D	H	
CH2684	600	600	725	£309.00
CH2694	800	800	725	£363.00



HIGH TABLE

	Dimensions			RRP
	W	D	H	
CH2685	600	600	1105	£395.00
CH2695	800	800	1105	£435.00

TOP FINISHES // FRAME FINISHES

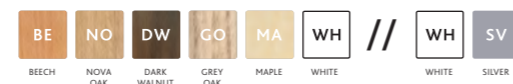

E&EO. All items are subject to VAT, where applicable.



COFFEE TABLES

5 YR
COMPONENT
GUARANTEE

MADE
TO
ORDER
30 DAYS

5 YR
COMPONENT
GUARANTEE



WOODEN SQUARE TABLE

	Dimensions			RRP
	W	D	H	
MMIT-1	555	555	400	£472.00

FINISH

WH

WOODEN RECTANGULAR TABLE

	Dimensions			RRP
	W	D	H	
MMIT-2	1295	555	400	£726.00

- Four leg wooden frame
- White top and a natural finish for the legs

ICEBERG SQUARE TABLE

	Dimensions			RRP
	W	D	H	
OF0303	635	635	460	£270.00

FINISH

BE

ICEBERG RECTANGULAR TABLE

	Dimensions			RRP
	W	D	H	
OF0302	1220	635	460	£393.00

- Ideal for reception areas



SPIRIT FROSTED GLASS TOP TABLE

	Dimensions			RRP
	W	D	H	
ST10C Chrome Wire Base	680	680	420	£365.00

FINISHES



SPIRIT WOODEN TOP TABLE

	Dimensions			RRP
	W	D	H	
ST11C Chrome Wire Base	680	680	420	£275.00

- Perfect for breakout and reception areas



ASTRAL LOW

	Dimensions			RRP
	W	D	H	
CH2677	600	600	420	£205.00

TOP FINISHES // FRAME FINISH



- FR: Low
- Material: Wood veneer or high gloss lacquer



TRIPOD COFFEE TABLE

	Dimensions			RRP
	W	D	H	
CH2670	500	500	410	£117.00
CH2671	500	500	455	£128.00
CH2672	750	750	520	£188.00

FINISH

WH



CIRCULAR COFFEE TABLE

	Dimensions			RRP
	W	D	H	
CT11/CIR08	800	800	425	£485.00

FINISH



- Stylish 25mm circular MFC top
- Chrome 4 star base with protective feet

RECEPTION

// 10

Great first impressions are essential, and nothing says welcome more than a new open space featuring a contemporary reception unit and a big smile. With our modular units, space needn't ever be an issue - create your own.

CONTENTS

- 164 Invite Reception
- 168 Modular Reception
- 170 Reception

INVITE RECEPTION

5 YR COMPONENT GUARANTEE
MADE TO ORDER
30 DAYS



CONVEX 90° BASE UNITS

	Dimensions			RRP
	R	D	H	
PRUTR9-8P	900	800	727	£642.00
PRUTR12-8P	1200	800	727	£913.00

// NOTE: Please specify if pre-drilling to accept shelf is required (included in price)



CONCAVE 90° BASE UNIT

	Dimensions			RRP
	R	D	H	
PRUTCR12-8P	1200	800	727	£813.00

// NOTE: Please specify if pre-drilling to accept shelf is required (included in price)



CONVEX 45° BASE UNITS

	Dimensions			RRP
	R	D	H	
PRUTS9-8P	900	800	727	£642.00
PRUTS12-8P	1200	800	727	£813.00
PRUTS18-8P	1800	800	727	£933.00

// NOTE: Please specify if pre-drilling to accept shelf is required (included in price)



CONCAVE 45° BASE UNIT

	Dimensions			RRP
	R	D	H	
PRUTCS12-8P	1200	800	727	£813.00

// NOTE: Please specify if pre-drilling to accept shelf is required (included in price)



CONVEX 90° BASE UNITS WITH COUNTER TOPS

	Dimensions			RRP
	R	D	H	
PRUTR9-8C	900	800	1192	£1029.00
PRUTR12-8C	1200	800	1192	£1300.00



CONCAVE 90° BASE UNIT WITH COUNTER TOP

	Dimensions			RRP
	R	D	H	
PRUTCR12-8C	1200	800	1192	£1200.00



CONVEX 45° BASE UNIT WITH COUNTER TOPS

	Dimensions			RRP
	R	D	H	
PRUTS9-8C	900	800	727	£1029.00
PRUTS12-8C	1200	800	727	£1300.00
PRUTS18-8C	1800	800	727	£1495.00



CONCAVE 45° BASE UNIT WITH COUNTER TOP

	Dimensions			RRP
	R	D	H	
PRUTCS12-8C	1200	800	1192	£1200.00



RECTANGULAR BASE UNITS

	Dimensions			RRP
	W	D	H	
PRUT08-8P	800	727	800	£368.00
PRUT10-8P	1000	727	800	£415.00
PRUT12-8P	1200	727	800	£430.00
PRUT14-8P	1400	727	800	£435.00
PRUT16-8P	1600	727	800	£454.00
PRUT18-8P	1800	727	800	£485.00
PRUT20-8P	2000	727	800	£513.00

// NOTE: Please specify if pre-drilling to accept shelf is required (included in price)



WHEELCHAIR ACCESS BASE UNITS

	Dimensions			RRP
	W	D	H	
PRUT16-8W	1600	800	727	£454.00
PRUT18-8W	1800	800	727	£485.00



RIPPLE BASE UNIT

	Dimensions			RRP
	W	D	H	
PRUTRP12-8P	1200	1050	727	£813.00

// NOTE: Please specify if pre-drilling to accept shelf is required (included in price)



RIPPLE BASE UNIT WITH COUNTER TOP

	Dimensions			RRP
	W	D	H	
PRUTRP12-8C	1200	1050	1192	£1299.00

MFC FINISHES



INVITE RECEPTION

5 YR COMPONENT GUARANTEE
MADE TO ORDER
30 DAYS



PEDESTALS

	Drawers	Dimensions			RRP
		W	D	H	
PDHP82	2	434	800	727	£373.00
PDHP83	3	434	800	727	£373.00
PDHP84	4	434	800	727	£373.00

SINGLE DOOR CUPBOARD

	Dimensions			RRP
	W	D	H	
PSD04-8	434	800	727	£395.00

- Shelf included
- Available in RH or LH



DOUBLE DOOR CUPBOARDS

	Dimensions			RRP
	W	D	H	
PSD08-8	800	800	727	£468.00
PSD10-8	1000	800	727	£505.00

HATCH MODULE

	Dimensions			RRP
	W	D	H	
PRHM-8	1000	800	727	£500.00

- Available in RH or LH
- Hatch module must be attached to either a wall or an adjacent desk
- Fixings not included

• Shelf included

MFC FINISHES



// NOTE 1: These Receptions are delivered built-up. Therefore customers must complete a questionnaire about access.

// NOTE 2: When situated against a wall, the Lift-up Hatch and Gate unit must be firmly secured to wall. This is the customers responsibility and instructions will be left with the unit.



Lift-Up Hatch and Gate (See Note 2)



Cut-Back Leg



Pigeon Hole Option



STRAIGHT RECEPTION SHELVES

	Dimensions			RRP	
	W	D	H	MFC	GLASS
PRS08	800	325	245	£197.00	£355.00
PRS10	1000	325	245	£206.00	£375.00
PRS12	1200	325	245	£214.00	£420.00
PRS14	1400	325	245	£226.00	£461.00
PRS16	1600	325	245	£239.00	£511.00
PRS18	1800	325	245	£248.00	£555.00
PRS20	2000	325	245	£258.00	£611.00



RIPPLE RECEPTION SHELVES

	Dimensions			RRP	
	W	D	H	MFC	GLASS
PRSRP12	1200	325	245	£249.00	£1371.00

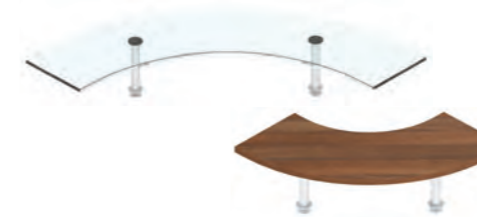

90° RECEPTION SHELVES

		Dimensions			RRP	
		W	D	H	MFC	GLASS
PRSR9	Convex	900	325	245	£216.00	£934.00
PRSR12	Convex	1200	325	245	£247.00	£1371.00
PRSR18	Convex	1800	325	245	£310.00	£1681.00
PRSCR12	Concave	1200	325	245	£217.00	£934.00



45° RECEPTION SHELVES

		Dimensions			RRP	
		W	D	H	MFC	GLASS
PRSS9	Convex	900	325	245	£218.00	£934.00
PRSS12	Convex	1200	325	245	£249.00	£1371.00
PRSCS12	Concave	1200	325	245	£217.00	£934.00



COUNTER TOP UNITS

	Dimensions			RRP
	W	D	H	
PRCT08	800	325	465	£207.00
PRCT10	1000	325	465	£223.00
PRCT12	1200	325	465	£238.00
PRCT14	1400	325	465	£250.00
PRCT16	1600	325	465	£266.00
PRCT18	1800	325	465	£278.00
PRCT20	2000	325	465	£288.00



PIGEON HOLE UNIT

	Dimensions			RRP
	W	D	H	
PRPHU	560	300	439	£224.00

• Unit can be sited under any rectangular counter top unit

MODULAR RECEPTION

5^{YR}
COMPONENT
GUARANTEE

25^{MM}
TOP
THICKNESS



STRAIGHT UNITS

	Dimensions			RRP
	W	D	H	
RCM800SBU	800	800	742	£270.00
RCM1200SBU	1200	800	742	£332.00
RCM1600SBU	1600	800	742	£373.00

CORNER UNIT

	Dimensions			RRP
	W	D	H	
RCMCB	800	800	742	£337.00

STRAIGHT TOPS

	Dimensions			RRP
	W	D	H	
RCM800SHU	800	315	400	£172.00
RCM1200SHU	1200	315	400	£182.00
RCM1600SHU	1600	315	400	£234.00

CORNER TOP

	Dimensions			RRP
	W	D	H	
RCMCH	800	800	400	£239.00

FINISHES



- Combine base units and optional counter tops to create your ideal solution
- 25mm top thickness
- Reception units are offered in 6 wood finishes to compliment your office



RECEPTION

5^{YR}
COMPONENT
GUARANTEE

25^{MM}
TOP
THICKNESS



UNITS

	Dimensions			RRP
	W	D	H	
RCA1400	1460	890	1165	£575.00
RCA1600	1660	890	1165	£631.00

UNIT WITH EXTENSIONS

	Dimensions			RRP
	W	D	H	
RCA1400EX	2400	890	1165	£746.00
RCA1600EX	2600	890	1165	£800.00



- A self-contained reception unit with a high shelf and private desk with cable port
- Extension unit available for extra space or to allow access for wheelchair users
- A light is also available to illuminate the back of the unit

LIGHTING PACK

	RRP
RCALIGHT	£167.00

TOP & SIDE FINISHES // EXTENTION LEG FINISHES

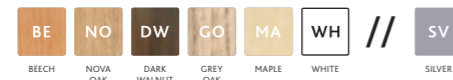

RECEPTION MIX & MATCH

The reception desk has the option to separately pick the finish of the tops and sides, enabling you to mix finishes and create a reception unit that fits in with the office decor.

When ordering, select the finish for **Box A** to choose the desk and reception tops and select the finish for **Box B** to choose the front and side panel finish.

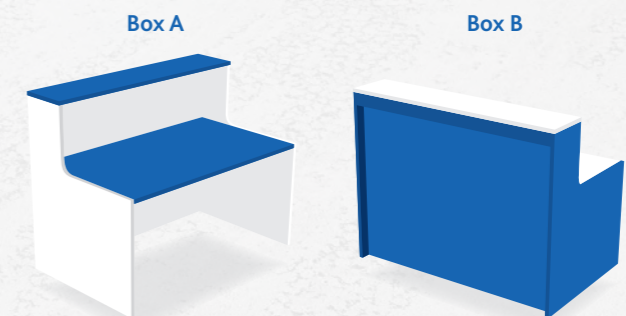

THINGS TO CONSIDER

The correct office chair is a very important decision to make. The right chair promotes good posture and comfort, which enhances productivity and ensures a happy, competent workforce. The average office chair can be in use for 1900 hours over the course of a year. Our selection of office seating ranges from operator, through to executive and posture seating.

IMPORTANT THINGS TO CONSIDER:



MECHANISM USER GUIDE

	<p>FIXED BACK</p> <ul style="list-style-type: none"> • Seat moves up and down • Back can be raised or lowered • The backrest angle is fixed 		<p>PERMANENT CONTACT (PCB)</p> <ul style="list-style-type: none"> • Seat moves up and down • Back can be raised or lowered • Backrest angle can be fixed or set to free float - i.e. in 'permanent contact' with your back is fixed
	<p>ASYNCHRO / ASYNCHRO TORSION</p> <ul style="list-style-type: none"> • Seat moves up and down • Back can be raised or lowered • Backrest angle can be fixed or set to free float • Seat angle can be fixed to desired angle • Torsion control knob can be adjusted to match body weight 		<p>LOCK TILT</p> <ul style="list-style-type: none"> • Seat moves up and down • Tilt of chair can be locked or set to free float • Torsion control knob can be adjusted to match body weight
	<p>SYNCHRO</p> <ul style="list-style-type: none"> • Seat moves up and down • Backrest and seat angle can be fixed or set to free float (2:1 ratio) • Synchro chairs can be fixed in either 3, 4 or 5 positions • Torsion control knob can be adjusted to match body weight 		<p>KNEE - TILT</p> <ul style="list-style-type: none"> • Seat moves up and down • Backrest and seat angle can be fixed or set to free float (2:1 ratio) • Knee tilt chairs can be fixed in either 3, 4 or 5 positions • Torsion control knob can be adjusted to match body weight
	<p>RATCHET BACK</p> <ul style="list-style-type: none"> • Back can be raised or lowered independently of chair functions 		<p>LUMBAR SUPPORT</p> <ul style="list-style-type: none"> • Backrest provides support for the natural 'S' shape of the spine • Prevents slumping and reduces stress on the spine and pelvis
	<p>SEAT SLIDE</p> <ul style="list-style-type: none"> • Seat depth can be increased or decreased independently of chair functions 		<p>STACKING CHAIR</p> <ul style="list-style-type: none"> • Designed to be safely stacked • Recommended number of chairs per stack is stated in product details if relevant

Want to match your own décor? We offer an exciting unlimited fabrics service which allows you to choose your own fabric, and we'll do the rest. Look out for our unlimited fabrics icon on all products included in this service. Please see pages 414 - 419 for fabric options on seating.



SEATING FAMILIES

// 11

There's nothing quite like family, and we understand this. Just like family, you might share the same name, but everybody has unique qualities. Our seating family section showcases a range of seating family ranges that allow for consistency without compromising on tailoring for individual uses.



CONTENTS

- 176 Rome
- 180 Vogue
- 182 Denali
- 184 Air Task
- 186 Milan

ROME MESH HB

5 YR COMPONENT GUARANTEE

2 YR UPHOLSTERY GUARANTEE

115 KG WEIGHT TOLERANCE

8 H HOURS USAGE



	Seat Dimensions	Back Dimensions	RRP
CH7000 // ROME MESH HB	D475 W500 H435 - 540	W465 H580	£302.00
AC7008 // 1D ADJUSTABLE ARMS			£58.00
AC7009 // 3D ADJUSTABLE ARMS			£68.00
AC7010 // FIXED ARMS			£47.00

FR: Med
Fabric: 100% Man-made
Mechanism: Synchro / torsion

FABRIC FINISHES // FRAME FINISHES



// NOTE: Model shown is CH7000 + AC7008

ROME MESH HB + HEADREST

5 YR COMPONENT GUARANTEE

2 YR UPHOLSTERY GUARANTEE

115 KG WEIGHT TOLERANCE

8 H HOURS USAGE



	Seat Dimensions	Back Dimensions	RRP
CH7001 // ROME MESH HB + HEADREST	D490 W500 H450 - 580	W460 H560	£352.00
AC7008 // 1D ADJUSTABLE ARMS			£58.00
AC7009 // 3D ADJUSTABLE ARMS			£68.00
AC7010 // FIXED ARMS			£47.00

FR: Med
Fabric: 100% Man-made
Mechanism: Synchro / torsion

FABRIC FINISHES // FRAME FINISHES



// NOTE: Model shown is CH7001 + AC7009



- High back with lumbar support in breathable mesh for comfort all day
 - A range of arms are available, either fixed, height-adjustable or 3D
- //NOTE:** Only black frame is stocked with blue & black fabric

ROME HB + HEADREST

5 YR COMPONENT GUARANTEE
2 YR UPHOLSTERY GUARANTEE
115 KG WEIGHT TOLERANCE
8 H HOURS USAGE



- Featuring a synchro mechanism to enable the user to adjust both height and tilt level
- Only available in Mirage fabric

// NOTE: Only black frame is stocked with blue & black fabric

	Seat Dimensions	Back Dimensions	RRP
CH7011 // ROME HB + HEADREST	D495 W500 H430 - 560	W440 H520	£372.00
AC7008 // 1D ADJUSTABLE ARMS			£58.00
AC7009 // 3D ADJUSTABLE ARMS			£68.00
AC7010 // FIXED ARMS			£47.00

FR: Med
Fabric: 100% Man-made
Mechanism: Synchro / torsion / ratchet back



// NOTE: Model shown is CH7011 + AC7009

ROME MB

5 YR COMPONENT GUARANTEE
2 YR UPHOLSTERY GUARANTEE
115 KG WEIGHT TOLERANCE
8 H HOURS USAGE



- Featuring a synchro mechanism to enable the user to adjust both height and tilt level
- Only available in Mirage fabric

// NOTE: Only black frame is stocked with blue & black fabric

	Seat Dimensions	Back Dimensions	RRP
CH7012 // ROME MB	D495 W500 H430 - 560	W440 H450	£342.00
AC7008 // 1D ADJUSTABLE ARMS			£58.00
AC7009 // 3D ADJUSTABLE ARMS			£68.00
AC7010 // FIXED ARMS			£47.00

FR: Med
Fabric: 100% Man-made
Mechanism: Synchro / torsion / ratchet back



// NOTE: Model shown is CH7012 + AC7008

ROME HB

5 YR COMPONENT GUARANTEE
2 YR UPHOLSTERY GUARANTEE
115 KG WEIGHT TOLERANCE
8 H HOURS USAGE



- Featuring a synchro mechanism to enable the user to adjust both height and tilt level
- Only available in Mirage fabric

// NOTE: Only black frame is stocked with blue & black fabric

	Seat Dimensions	Back Dimensions	RRP
CH7010 // ROME HB	D495 W500 H430 - 560	W440 H520	£352.00
AC7008 // 1D ADJUSTABLE ARMS			£58.00
AC7009 // 3D ADJUSTABLE ARMS			£68.00
AC7010 // FIXED ARMS			£47.00

FR: Med
Fabric: 100% Man-made
Mechanism: Synchro / torsion / ratchet back



// NOTE: Model shown is CH7010 + AC7008

ROME VISITOR

5 YR COMPONENT GUARANTEE
2 YR UPHOLSTERY GUARANTEE
115 KG WEIGHT TOLERANCE
8 H HOURS USAGE



- Supplied with a chrome cantilever base
- Only available in Mirage fabric

// NOTE: Only black frame is stocked with blue & black fabric

	Seat Dimensions	Back Dimensions	RRP
CH7013 // ROME VISITOR	D490 W500 H480	W440 H450	£342.00
AC7010 // FIXED ARMS			£47.00

FR: Med
Fabric: 100% Man-made



// NOTE: Model shown is CH7013 + AC7010

VOGUE HB + HEADREST

5 YR COMPONENT GUARANTEE
2 YR UPHOLSTERY GUARANTEE
115 KG WEIGHT TOLERANCE
8 H HOURS USAGE



- A black high back executive mesh chair with a built-in headrest
- Supplied with 2D adjustable arms
- Synchro mechanism to adjust height and tilt

	Seat Dimensions	Back Dimensions	RRP
CH2621 // VOGUE HB + HEADREST	D500 W500 H450 - 540	W465 H725	£374.00

FR: Low
Fabric: Mesh / 100% Man-made
Mechanism: Synchro 4
Arms: 2D adjustable

FABRIC FINISH

BK

VOGUE VISITOR

5 YR COMPONENT GUARANTEE
2 YR UPHOLSTERY GUARANTEE
115 KG WEIGHT TOLERANCE
8 H HOURS USAGE



- A black mid back mesh visitor chair with cantilever base
- Supplied with fixed arms
- Black cantilever base

	Seat Dimensions	Back Dimensions	RRP
CH2623 // VOGUE VISITOR	D500 W500 H435	W465 H555	£276.00

FR: Low
Fabric: Mesh / 100% Man-made
Arms: Fixed

FABRIC FINISH

BK

VOGUE HB

5 YR COMPONENT GUARANTEE
2 YR FABRIC GUARANTEE
115 KG WEIGHT TOLERANCE
8 H HOURS USAGE



- A black high back mesh office chair with a chrome base
- Supplied with 2D adjustable arms
- Synchro mechanism to adjust height and tilt

	Seat Dimensions	Back Dimensions	RRP
CH2622 // VOGUE HB	D500 W500 H480 - 560	W465 H555	£341.00

FR: Low
Fabric: Mesh / 100% Man-made
Mechanism: Synchro 4
Arms: 2D adjustable

FABRIC FINISH

BK



DENALI HB



- A contemporary high back mesh chair with swivel base & built-in mesh headrest
- Supplied with height adjustable arms and in-built adjustable lumbar support

5YR
COMPONENT
GUARANTEE

2YR
UPHOLSTERY
GUARANTEE

115KG
WEIGHT
TOLERANCE

8H
HOURS
USAGE

	Seat Dimensions	Back Dimensions	RRP
CH3300BK // DENALI HB + HEADREST	D500 W490 H450 - 525	W475 H650	£188.00

FR: Low
Fabric: Mesh / 100% Man-made
Mechanism: Lock tilt / lumbar support / torsion
Arms: 1D adjustable arms

FABRIC FINISH

BK

DENALI VISITOR



- A contemporary mid back mesh chair with a chrome cantilever base
- Supplied with black fixed arms
- Chrome cantilever base and skid feet

5YR
COMPONENT
GUARANTEE

2YR
UPHOLSTERY
GUARANTEE

115KG
WEIGHT
TOLERANCE

8H
HOURS
USAGE

	Seat Dimensions	Back Dimensions	RRP
CH3302BK // DENALI VISITOR	D490 W470 H450	W475 H575	£155.00

FR: Low
Fabric: Mesh / 100% Man-made
Arms: Fixed

FABRIC FINISH

BK

DENALI MB



- A contemporary mid back mesh chair with black swivel base
- Supplied with black fixed arms

5YR
COMPONENT
GUARANTEE

2YR
UPHOLSTERY
GUARANTEE

115KG
WEIGHT
TOLERANCE

8H
HOURS
USAGE

	Seat Dimensions	Back Dimensions	RRP
CH3301BK // DENALI MB	D490 W470 H430 - 530	W475 H575	£155.00

FR: Low
Fabric: Mesh / 100% Man-made
Mechanism: Lock tilt / torsion
Arms: Fixed

FABRIC FINISH

BK



AIR TASK MESH BACK



- Breathable, height adjustable double membrane mesh back
- Mechanical back rake mechanism
- Seat height adjustment
- Moulded base
- Priced in Camira Advantage
- For options, see page 185

	Seat Dimensions	Back Dimensions	RRP
AIR01B // WITH NO ARMS	D450 W480 H450 - 570	W420 H500 - 560	£186.00
AIR02B // WITH FIXED "T" ARMS	D450 W480 H450 - 570	W420 H500 - 560	£231.00
AIR03B // WITH 1D ARMS	D450 W480 H450 - 570	W420 H500 - 560	£247.00

FR: Low
Fabric: Mesh / 100% Man-made
Mechanism: Back rake

FABRIC FINISH



// NOTE: Model shown is AIR03B

5YR COMPONENT GUARANTEE	2YR UPHOLSTERY GUARANTEE	150KG WEIGHT TOLERANCE	8H HOURS USAGE	MADE TO ORDER 20 DAYS
--------------------------------------	---------------------------------------	-------------------------------------	-----------------------------	---

AIR VISITOR MESH BACK



- A contemporary mid back mesh chair with a black cantilever base
- Supplied with black fixed arms
- Black cantilever base and skid feet
- Priced in Camira Advantage

	Seat Dimensions	Back Dimensions	RRP
AIRC1B // WITH NO ARMS	D450 W480 H460	W420 H520	£150.00
AIRC2B // WITH FIXED "T" ARMS	D450 W480 H460	W420 H520	£194.00

FR: Low
Fabric: Mesh / 100% Man-made
Mechanism: Back rake

FABRIC FINISH



// NOTE: Model shown is AIRC2B

5YR COMPONENT GUARANTEE	2YR UPHOLSTERY GUARANTEE	150KG WEIGHT TOLERANCE	8H HOURS USAGE	MADE TO ORDER 20 DAYS
--------------------------------------	---------------------------------------	-------------------------------------	-----------------------------	---

AIR TASK RIBBED BACK



- Stylish, height adjustable ribbed upholstered back
- Mechanical back rake mechanism
- Seat height adjustment
- Moulded base
- Priced in Camira Advantage
- For options, see page 185

	Seat Dimensions	Back Dimensions	RRP
AIR04B // WITH NO ARMS	D450 W480 H450 - 570	W420 H500 - 560	£193.00
AIR05B // WITH FIXED "T" ARMS	D450 W480 H450 - 570	W420 H500 - 560	£238.00
AIR06B // WITH 1D ARMS	D450 W480 H450 - 570	W420 H500 - 560	£256.00

FR: Low
Fabric: Mesh / 100% Man-made
Mechanism: Back rake

FABRIC FINISH



// NOTE: Model shown is AIR04B

5YR COMPONENT GUARANTEE	2YR UPHOLSTERY GUARANTEE	150KG WEIGHT TOLERANCE	8H HOURS USAGE	MADE TO ORDER 20 DAYS
--------------------------------------	---------------------------------------	-------------------------------------	-----------------------------	---



Options	RRP
AIRFA FOLDAWAY HEIGHT ADJUSTABLE ARMS	£75.00
AIRPBS SILVER BASE	£47.00
AIRPBC CHROME BASE	£47.00
AIRSS SEAT SLIDE	£30.00
AIRSY SYNCHRO MECHANISM	£45.00
AIRIM INDEPENDENT MECHANISM	£15.00

* COLOURED MESH BACKS AVAILABLE - ASK SALES

MILAN SWIVEL

5 YR COMPONENT GUARANTEE	2 YR UPHOLSTERY GUARANTEE	115 KG WEIGHT TOLERANCE	8 H HOURS USAGE
---------------------------------------	--	--------------------------------------	------------------------------



- Swivel chair on a chrome base with black castors
- Available in a wide range of seat colours

// **NOTE:** Stocked in PU, unlimited in Mirage fabric

	Seat Dimensions	Back Dimensions	RRP
CH7005 // MILAN SWIVEL	D420 W475 H395 - 525	W430 H400	£382.00

FR: Med
Fabric: Leather look / 100% Man-made
Mechanism: Lock tilt
Arms: Fixed

PU FINISH // FABRIC FINISH



MILAN CONFERENCE

5 YR COMPONENT GUARANTEE	2 YR UPHOLSTERY GUARANTEE	115 KG WEIGHT TOLERANCE	8 H HOURS USAGE
---------------------------------------	--	--------------------------------------	------------------------------



- Swivel chair on a chrome base
- Available in a wide range of seat colours

// **NOTE:** Stocked in PU, unlimited in Mirage fabric

	Seat Dimensions	Back Dimensions	RRP
CH7008 // MILAN 4 STAR	D420 W470 H470	W435 H400	£402.00

FR: Med
Fabric: Leather look / 100% Man-made

PU FINISH // FABRIC FINISH



MILAN 4-LEG

5 YR
COMPONENT
GUARANTEE

2 YR
UPHOLSTERY
GUARANTEE

115 KG
WEIGHT
TOLERANCE

8 H
HOURS
USAGE



- Chrome 4 leg frame
 - Available in a wide range of seat colours
- // NOTE:** Stocked in PU, unlimited in Mirage fabric

	Seat Dimensions	Back Dimensions	RRP
CH7007 // MILAN 4-LEG	D425 W480 H460	W435 H365	£262.00

FR: Med
Fabric: Leather look / 100% Man-made

PU FINISH // FABRIC FINISH



MILAN BAR STOOL

5 YR
COMPONENT
GUARANTEE

2 YR
UPHOLSTERY
GUARANTEE

115 KG
WEIGHT
TOLERANCE

8 H
HOURS
USAGE



- High bar stool with skid feet
 - Available in a wide range of seat colours
- // NOTE:** Stocked in PU, unlimited in Mirage fabric

	Seat Dimensions	Back Dimensions	RRP
CH7004 // MILAN BAR STOOL	D370 W410 H760	W390 H210	£262.00

FR: Med
Fabric: Leather look / 100% Man-made

PU FINISH // FABRIC FINISH



MILAN SKID

5 YR
COMPONENT
GUARANTEE

2 YR
UPHOLSTERY
GUARANTEE

115 KG
WEIGHT
TOLERANCE

8 H
HOURS
USAGE



- Visitor chair frame with skid frame
 - Available in a wide range of seat colours
- // NOTE:** Stocked in PU, unlimited in Mirage fabric

	Seat Dimensions	Back Dimensions	RRP
CH7006 // MILAN SKID BASE	D425 W475 H465	W435 H390	£277.00

FR: Med
Fabric: Leather look / 100% Man-made

PU FINISH // FABRIC FINISH



TASK SEATING

// 12

There's nothing worse than an uncomfortable chair, especially uncomfortable task chairs, as they're designed to offer full support in all areas to those who use them. Our task chairs are designed to make every day easy.



CONTENTS

192	Willow	201	Carbon
193	Ash	202	Spark
194	Kind	202	Vida
196	Kind Mesh	203	Air Task
198	Maldini	203	Start Mesh
199	Zico		
199	Scuba		
200	Kempes		
200	Fonseca 2		
201	Marlos		

WILLOW

10^{YR}
COMPONENT
GUARANTEE

2^{YR}
UPHOLSTERY
GUARANTEE

136^{KG}
WEIGHT
TOLERANCE

8^H
HOURS
USAGE



- High back with lumbar support and breathable mesh for comfort all day
- 2D adjustable arms
- Fully ergonomic and stylish design

	Seat Dimensions	Back Dimensions	RRP
CH0736 // WILLOW	D510 W505 H470 - 585	W540 H730	£703.00

FR: Med
Fabric: 100% Man-made
Mechanism: 2 lever synchro / torsion / seat slide / height adjustable lumbar
Arms: 2D adjustable

FABRIC FINISH



ASH

10^{YR}
COMPONENT
GUARANTEE

2^{YR}
UPHOLSTERY
GUARANTEE

136^{KG}
WEIGHT
TOLERANCE

8^H
HOURS
USAGE



- Ratchet back height lumbar adjustment
- Weight balanced synchro mechanism with back angle adjustment
- Moulded foam back over mesh suspension

	Seat Dimensions	Back Dimensions	RRP
CH0737 // ASH	D515 W500 H425 - 540	W450 H605	£599.00

FR: Med
Fabric: 100% Man-made
Mechanism: Weight adjusted synchro / ratchet back
Arms: 3D adjustable

FABRIC FINISH



KIND FULL BACK TASK CHAIR

5YR COMPONENT GUARANTEE	2YR UPHOLSTERY GUARANTEE	150KG WEIGHT TOLERANCE	8-10^H HOURS USAGE	MADE TO ORDER 20 DAYS
--------------------------------------	---------------------------------------	-------------------------------------	---	---



- Fixed aluminium arms
- Upholstered seat & back
- Height adjustable back
- Chrome gas lift
- Polished base with 60mm hard castors
- Priced in Camira Advantage

// NOTE: See page 196 for options

	Seat Dimensions	Back Dimensions	RRP
KDT32C // FIXED ALUMINIUM ARMS	D440 W460 H460-580	W450 H600-760	£544.00

FR: Low
Fabric: 100% Man-made
Mechanism: Synchronised mechanism with seat slide
Arms: Fixed



// NOTE: Shown with optional Chrome Base

KIND HB TASK CHAIR

5YR COMPONENT GUARANTEE	2YR UPHOLSTERY GUARANTEE	150KG WEIGHT TOLERANCE	8-10^H HOURS USAGE	MADE TO ORDER 20 DAYS
--------------------------------------	---------------------------------------	-------------------------------------	---	---



- Upholstered seat & back
- Height adjustable back
- 60mm hard castors
- Body weight responsive mechanism
- Black nylon base
- Priced in Camira Advantage

// NOTE: See page 196 for options

	Seat Dimensions	Back Dimensions	RRP
KDT21B // WITH NO ARMS	D440 W460 H440-560	W450 H620-680	£296.00
KDT23B // WITH 2D ARMS	D440 W460 H440-560	W450 H620-680	£368.00

FR: Low
Fabric: 100% Man-made
Mechanism: Body weight responsive



// NOTE: Model shown KDT23B

KIND FULL BACK WITH HEADREST

5YR COMPONENT GUARANTEE	2YR UPHOLSTERY GUARANTEE	150KG WEIGHT TOLERANCE	8-10^H HOURS USAGE	MADE TO ORDER 20 DAYS
--------------------------------------	---------------------------------------	-------------------------------------	---	---



- Headrest is standard and not adjustable
- Upholstered seat & back
- Height adjustable back
- Polished base with 60mm hard castors
- Chrome gas lift
- Priced in Camira Advantage

// NOTE: See page 196 for options

	Seat Dimensions	Back Dimensions	RRP
KDT42C // FIXED ALUMINIUM ARMS	D440 W460 H460-580	W450 H770-830	£634.00

FR: Low
Fabric: 100% Man-made
Mechanism: Synchronised mechanism with seat slide
Arms: Fixed



// NOTE: Shown with optional Chrome Base

KIND MB TASK CHAIR

5YR COMPONENT GUARANTEE	2YR UPHOLSTERY GUARANTEE	150KG WEIGHT TOLERANCE	8-10^H HOURS USAGE	MADE TO ORDER 20 DAYS
--------------------------------------	---------------------------------------	-------------------------------------	---	---



- Upholstered seat & back
- Height adjustable back
- 60mm hard castors
- Body weight responsive mechanism
- Black nylon base
- Priced in Camira Advantage

// NOTE: See page 196 for options

	Seat Dimensions	Back Dimensions	RRP
KDT11B // WITH NO ARMS	D440 W460 H440-560	W450 H520-580	£288.00
KDT13B // WITH 2D ARMS	D440 W460 H440-560	W450 H520-580	£362.00

FR: Low
Fabric: 100% Man-made
Mechanism: Body weight responsive



// NOTE: Model shown is KDT11B

KIND MESH HIGH BACK CHAIR

5 YR COMPONENT GUARANTEE	2 YR UPHOLSTERY GUARANTEE	150 KG WEIGHT TOLERANCE	8-10^H HOURS USAGE	MADE TO ORDER 20 DAYS
---------------------------------------	--	--------------------------------------	---	---



- Dual mesh back with upholstered seat
- Mesh priced is Gabriel Omega, from which 9 colours are available
- Black nylon base with 60mm hard castors as standard
- Priced in Camira Advantage

	Seat Dimensions	Back Dimensions	RRP
KDT01B // NO ARMS	D440 W450 H440-560	W450 H620	£316.00 •
KDT02B // WITH FIXED ARMS	D440 W450 H440-560	W450 H620	£367.00 •
KDT03B // WITH 2D ARMS	D440 W450 H440-560	W450 H620	£389.00 •



FR: Low
Fabric: Mesh / 100% Man-made
Mechanism: Body weight responsive mechanism with adjustable lumbar support

FABRIC FINISH



// NOTE: Model shown is KDT03B with Chrome Base (C)

KIND CHAIR OPTIONS

Options	RRP
KDSY // SYNCHRO MECHANISM	£45.00 •
KDSYT // SYNCHRO WITH SEAT TILT	£55.00 •
KDSS // SEAT SLIDE	£30.00 •
KDC // CHROME BASE	£101.00 •
KDCG // CHROME GAS LIFT	£8.00 •
KDHR // ADJUSTABLE HEAD REST (KDT21B & KDT23B & MESH ONLY)	£75.00 •
KDIL // INFLATABLE LUMBAR - NOT AVAILABLE FOR MESH	£38.00 •



MALDINI

5 YR COMPONENT GUARANTEE
 2 YR UPHOLSTERY GUARANTEE
 115 KG WEIGHT TOLERANCE
 8 H HOURS USAGE



- Supplied with white height adjustable arms
- Aluminium base
- Height adjustable headrest
- Seat slide and adjustable lumbar support

	Seat Dimensions	Back Dimensions	RRP
CH0782WH // MALDINI BLACK	D500 W520 H460 - 555	W480 H560	£311.00
CH0782WHBL // MALDINI BLUE	D500 W520 H460 - 555	W480 H560	£311.00

FR: Low
 Fabric: Mesh / 100% Man-made
 Mechanism: Asynchro / seat slide / torsion
 Arms: 1D adjustable

MESH FINISHES // FRAME FINISH
 BK BL // WH



ZICO

2 YR COMPONENT GUARANTEE
 2 YR UPHOLSTERY GUARANTEE
 115 KG WEIGHT TOLERANCE
 8 H HOURS USAGE



- Supplied with fixed arms to match the frame
- Discreet PCB mechanism with small levers, for a stylish and functional look
- Aluminium base

	Seat Dimensions	Back Dimensions	RRP
CH0799 // ZICO	D470 W470 H460 - 550	W440 H495	£238.00

FR: Low
 Fabric: Mesh
 Mechanism: PCB
 Arms: Fixed

MESH FINISH // FRAME FINISH
 BK // WH

SCUBA

5 YR COMPONENT GUARANTEE
 2 YR UPHOLSTERY GUARANTEE
 115 KG WEIGHT TOLERANCE
 8 H HOURS USAGE



- Supplied with fixed arms to match the frame
- Contemporary mesh chair with chrome base
- Black seat and grey mesh back

	Seat Dimensions	Back Dimensions	RRP
CH0792GR // SCUBA	D500 W510 H420 - 520	W465 H570	£311.00

FR: Low
 Fabric: Mesh / 100% Man-made
 Mechanism: Lock-tilt / torsion
 Arms: Fixed

FABRIC FINISH // FRAME FINISH
 BK // GR

KEMPES



- A modern, stylish black mesh-backed office chair with a built-in headrest
- Supplied with height adjustable arms
- Padded foam seat with textured covering

	Seat Dimensions	Back Dimensions	RRP
CH0780 // KEMPES	D500 W490 H410 - 510	W400 H490	£270.00

FR: Low
Fabric: Mesh / 100% Man-made
Mechanism: Lock tilt / torsion
Arms: 1D adjustable

FABRIC FINISH

BK

5 YR COMPONENT GUARANTEE
2 YR UPHOLSTERY GUARANTEE
115 KG WEIGHT TOLERANCE
8 H HOURS USAGE

MARLOS



- Folding flip-up arms
- Modern, stylish mesh-backed office chair
- Available in five colours

	Seat Dimensions	Back Dimensions	RRP
CH0790 // MARLOS	D500 W520 H450 - 545	W490 H580	£184.00

FR: Low
Fabric: Mesh / 100% Man-made
Mechanism: Lock tilt / torsion
Arms: Folding

FABRIC FINISHES

BK BL RD GN OR

5 YR COMPONENT GUARANTEE
2 YR UPHOLSTERY GUARANTEE
115 KG WEIGHT TOLERANCE
8 H HOURS USAGE

FONSECA 2



- A high back executive chair with a plush padded headrest and sides to hug the body
- Ample padding in seat to provide all-day comfort
- Supplied with black fixed arms and chrome base

	Seat Dimensions	Back Dimensions	RRP
CH2404 // FONSECA 2	D500 W490 H470 - 565	W490 H740	£211.00

FR: Medium
Fabric: Mesh / Leather look
Mechanism: Lock tilt / torsion
Arms: Fixed

FABRIC FINISH

BK

2 YR COMPONENT GUARANTEE
2 YR UPHOLSTERY GUARANTEE
115 KG WEIGHT TOLERANCE
8 H HOURS USAGE

CARBON



- A low back office chair with unique folding arms
- Mesh back keeps you cool all day
- Black and silver base as standard

	Seat Dimensions	Back Dimensions	RRP
CH1730 // CARBON	D505 W490 H470 - 570	W475 H500	£232.00

FR: Low
Fabric: Mesh / 100% Man-made
Mechanism: Lock tilt / torsion
Arms: Folding

FABRIC FINISH

BK

2 YR COMPONENT GUARANTEE
2 YR UPHOLSTERY GUARANTEE
115 KG WEIGHT TOLERANCE
8 H HOURS USAGE

SPARK



- Sliding seat as standard
- Modern design with a synchronous mechanism, a mesh back and 1D adjustable arms

	Seat Dimensions	Back Dimensions	RRP
CH0781 // SPARK	D470 W480 H430 - 550	W450 H540	£277.00

Unlimited Fabric Available
Please call for pricing

FR: Low
Fabric: Mesh / 100% Man-made
Mechanism: Synchronous
Arms: 1D adjustable



5 YR COMPONENT GUARANTEE	2 YR UPHOLSTERY GUARANTEE	115 KG WEIGHT TOLERANCE	8 H HOURS USAGE
---------------------------------------	--	--------------------------------------	------------------------------

AIR TASK MESH BACK



- Breathable, height adjustable double membrane mesh back
- PCB mechanism
- Seat height adjustment
- Priced in Camira Advantage

// NOTE: See page 185 for accessory options

	Seat Dimensions	Back Dimensions	RRP
AIRO1B // WITH NO ARMS	D450 W490 H450 - 570	W420 H500 - 560	£186.00 •
AIRO2B // WITH FIXED "T" ARMS	D450 W490 H450 - 570	W420 H500 - 560	£231.00 •
AIRO3B // WITH 1D ARMS	D450 W490 H450 - 570	W420 H500 - 560	£247.00 •

FR: Low
Fabric: Mesh / 100% Man-made
Mechanism: PCB

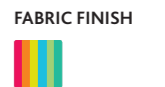

// NOTE: Model shown is AIRO3B

5 YR COMPONENT GUARANTEE	2 YR UPHOLSTERY GUARANTEE	150 KG WEIGHT TOLERANCE	8 H HOURS USAGE	MADE TO ORDER 20 DAYS
---------------------------------------	--	--------------------------------------	------------------------------	---------------------------------

VIDA



- Sliding seat as standard
- Modern design with a synchronous mechanism, a mesh back and adjustable arms
- Priced in Camira Advantage

	Seat Dimensions	Back Dimensions	RRP
VID // VIDA MESH	D475 W480 H480 - 600	W425 H495	£352.00 •

FR: Low
Fabric: Mesh / 100% Man-made
Mechanism: Synchronous
Arms: Adjustable



5 YR COMPONENT GUARANTEE	2 YR UPHOLSTERY GUARANTEE	150 KG WEIGHT TOLERANCE	8 H HOURS USAGE	MADE TO ORDER 20 DAYS
---------------------------------------	--	--------------------------------------	------------------------------	---------------------------------

START MESH



- A mesh-backed office chair with a chrome base, ideal for home offices
- Supplied with height adjustable arms
- Padded foam seat with textured covering

	Seat Dimensions	Back Dimensions	RRP
CH1743 // START MESH	D490 W490 H455 - 545	W460 H580	£139.00

FR: Low
Fabric: Mesh / 100% Man-made
Mechanism: Lock tilt / torsion
Arms: 1D adjustable

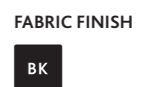

// NOTE: Shown with chrome base at additional cost

E&EO. All items are subject to VAT, where applicable.

STRATA

10 YR
COMPONENT
GUARANTEE

2 YR
UPHOLSTERY
GUARANTEE

152 KG
WEIGHT
TOLERANCE

24 H
HOURS
USAGE

PHYSIO APPROVED

ERGONOMIC FEATURES TESTED AND APPROVED FOR OFFICE USE BY A QUALIFIED PHYSIOTHERAPIST

24 HOUR 24 STONE

SUITABLE FOR CONTINUOUS USE IN DEMANDING WORKING ENVIRONMENTS



	Seat Dimensions	Back Dimensions	RRP
CH0735 // STRATA MESH HIGH BACK	D530 W520 H500 - 565	W545 H660	£658.00

FR: Low
Fabric: Mesh / 100% Man-made
Mechanism: Synchro 5 / seat slide
Arms: 1D adjustable

FABRIC FINISH

BK



E&EO. All items are subject to VAT, where applicable.

FONZ

5 YR
COMPONENT
GUARANTEE

2 YR
UPHOLSTERY
GUARANTEE

152 KG
WEIGHT
TOLERANCE

24 H
HOURS
USAGE

PHYSIO APPROVED

ERGONOMIC FEATURES TESTED AND APPROVED FOR OFFICE USE BY A QUALIFIED PHYSIOTHERAPIST

24 HOUR 24 STONE

SUITABLE FOR CONTINUOUS USE IN DEMANDING WORKING ENVIRONMENTS



	Seat Dimensions	Back Dimensions	RRP
CH0730 // FONZ	D460 W490 H495 - 575	W495 H660	£440.00

FR: Low
Fabric: Mesh / 100% Man-made
Mechanism: Synchro / torsion
Arms: 2D adjustable

FABRIC FINISH

BK BL



ALTO

5 YR COMPONENT GUARANTEE	2 YR FABRIC GUARANTEE	115 KG WEIGHT TOLERANCE	8 H HOURS USAGE
---------------------------------------	------------------------------------	--------------------------------------	------------------------------



	Seat Dimensions	Back Dimensions	RRP
CH1914 // ALTO	D490 W520 H470 - 565	W480 H570	£317.00

FR: Medium
Fabric: Mesh
Mechanism: Synchro / torsion / seat slide
Arms: 1D adjustable

FABRIC FINISH
BK



CHACHI

5 YR COMPONENT GUARANTEE	2 YR FABRIC GUARANTEE	115 KG WEIGHT TOLERANCE	8 H HOURS USAGE
---------------------------------------	------------------------------------	--------------------------------------	------------------------------

PHYSIO APPROVED

ERGONOMIC FEATURES TESTED AND APPROVED FOR OFFICE USE BY A QUALIFIED PHYSIOTHERAPIST



	Seat Dimensions	Back Dimensions	RRP
CH1910 // CHACHI	D510 W500 H450 - 540	W515 H750	£374.00

FR: Medium
Fabric: Mesh
Mechanism: Lock-tilt / torsion
Arms: 3D Adjustable

FABRIC FINISH
BK



CHEETAH

5 YR COMPONENT GUARANTEE

2 YR UPHOLSTERY GUARANTEE

152^{KG} WEIGHT TOLERANCE

24^H HOURS USAGE

PHYSIO APPROVED

ERGONOMIC FEATURES TESTED AND APPROVED FOR OFFICE USE BY A QUALIFIED PHYSIOTHERAPIST

24 HOUR 24 STONE

SUITABLE FOR CONTINUOUS USE IN DEMANDING WORKING ENVIRONMENTS



	Seat Dimensions	Back Dimensions	RRP
CH1110 // LEATHER CHEETAH	D490 W530 H490 - 550	W530 H735	£516.00
CH1111 // FABRIC CHEETAH	D490 W530 H490 - 550	W530 H735	£494.00

CH1110
FR: Low
Fabric: Leather faced
Mechanism: Asynchro / torsion / ratchet back / seat slide
Arms: 2D adjustable

CH1111
FR: Med
Fabric: Wool mix
Mechanism: Asynchro / torsion / ratchet back / seat slide
Arms: 2D adjustable

LEATHER FINISH // FABRIC FINISHES



E&EO. All items are subject to VAT, where applicable.

PANTHER

5 YR COMPONENT GUARANTEE

2 YR UPHOLSTERY GUARANTEE

152^{KG} WEIGHT TOLERANCE

24^H HOURS USAGE

PHYSIO APPROVED

ERGONOMIC FEATURES TESTED AND APPROVED FOR OFFICE USE BY A QUALIFIED PHYSIOTHERAPIST

24 HOUR 24 STONE

SUITABLE FOR CONTINUOUS USE IN DEMANDING WORKING ENVIRONMENTS



	Seat Dimensions	Back Dimensions	RRP
CH1101 // LEATHER PANTHER	D525 W515 H490 - 580	W525 H645	£483.00
CH1108 // FABRIC PANTHER	D525 W515 H490 - 580	W525 H645	£462.00

CH1101
FR: Low
Fabric: Leather faced
Mechanism: Asynchro / torsion / ratchet
Arms: 2D adjustable

CH1108
FR: Med
Fabric: Wool mix
Mechanism: Asynchro / torsion / ratchet
Arms: 2D adjustable

LEATHER FINISH // FABRIC FINISHES



VISTA

5^{YR} COMPONENT GUARANTEE	2^{YR} UPHOLSTERY GUARANTEE	152^{KG} WEIGHT TOLERANCE	24^H HOURS USAGE	UNLIMITED FABRICS
---	--	--	---	----------------------

PHYSIO APPROVED

ERGONOMIC FEATURES TESTED AND APPROVED FOR OFFICE USE BY A QUALIFIED PHYSIOTHERAPIST

24 HOUR 24 STONE

SUITABLE FOR CONTINUOUS USE IN DEMANDING WORKING ENVIRONMENTS



	Seat Dimensions	Back Dimensions	RRP
CH0903PU // VISTA HB BLACK PU	D510 W510 H485 - 585	W490 H580	£466.00
CH0903 // VISTA HB FABRIC	D510 W510 H485 - 585	W490 H580	£395.00

Unlimited Fabric Available

Please call for pricing

FR: Med
Fabric: 100% Man-made
Mechanism: Asynchro / torsion / seat slide / lumbar / ratchet back
Arms: 2D adjustable

PU FINISH // FABRIC FINISHES



E&EO. All items are subject to VAT, where applicable.

MARATHON

5^{YR} COMPONENT GUARANTEE	2^{YR} UPHOLSTERY GUARANTEE	152^{KG} WEIGHT TOLERANCE	24^H HOURS USAGE
---	--	--	---

PHYSIO APPROVED

ERGONOMIC FEATURES TESTED AND APPROVED FOR OFFICE USE BY A QUALIFIED PHYSIOTHERAPIST

24 HOUR 24 STONE

SUITABLE FOR CONTINUOUS USE IN DEMANDING WORKING ENVIRONMENTS



	Seat Dimensions	Back Dimensions	RRP
CH1105 // LEATHER MARATHON	D540 W530 H470 - 560	W490 H640	£429.00
CH1106 // FABRIC MARATHON	D540 W530 H470 - 560	W490 H640	£407.00

CH1105
FR: Low
Fabric: Leather faced
Mechanism: Asynchro / torsion / ratchet back
Arms: 2D adjustable

CH1106
FR: Med
Fabric: Wool mix
Mechanism: Asynchro / torsion / ratchet back
Arms: 2D adjustable

LEATHER FINISH // FABRIC FINISHES



CALL CENTRE

5 YR
COMPONENT
GUARANTEE

2 YR
UPHOLSTERY
GUARANTEE

152 KG
WEIGHT
TOLERANCE

24 H
HOURS
USAGE

PHYSIO APPROVED

ERGONOMIC FEATURES
TESTED AND APPROVED FOR
OFFICE USE BY A QUALIFIED
PHYSIOTHERAPIST

24 HOUR 24 STONE

SUITABLE FOR CONTINUOUS
USE IN DEMANDING WORKING
ENVIRONMENTS



	Seat Dimensions	Back Dimensions	RRP
CH0905 // CALL CENTRE	D460 W510 H480 - 570	W495 H650	£298.00

FR: Med
Fabric: 100% Man-made
Mechanism: Asynchro / torsion / ratchet back
Arms: 2D adjustable

FABRIC FINISH



CARACAL

5 YR
COMPONENT
GUARANTEE

2 YR
UPHOLSTERY
GUARANTEE

115 KG
WEIGHT
TOLERANCE

8 H
HOURS
USAGE

PHYSIO APPROVED

ERGONOMIC FEATURES
TESTED AND APPROVED FOR
OFFICE USE BY A QUALIFIED
PHYSIOTHERAPIST



	Seat Dimensions	Back Dimensions	RRP
CH0906 // CARACAL	D510 W515 H480 - 560	W500 H790	£326.00

FR: Med
Fabric: 100% Man-made
Mechanism: Asynchro & seat slide / ratchet back / lumbar
Arms: 1D adjustable

FABRIC FINISH



MAXI ERGO

5 YR COMPONENT GUARANTEE

2 YR UPHOLSTERY GUARANTEE

115 KG WEIGHT TOLERANCE

8 H HOURS USAGE

PHYSIO APPROVED

ERGONOMIC FEATURES TESTED AND APPROVED FOR OFFICE USE BY A QUALIFIED PHYSIOTHERAPIST

// NOTE: This chair is only physio approved when used with the 1D arm

STOCKED IN ADVANTAGE FABRIC



	Seat Dimensions	Back Dimensions	RRP
CH0808 + AC1040 // MAXI ERGO + 1D ARMS	D500 W520 H490 - 620	W500 H600	£352.00
CH0808 + AC1082 // MAXI ERGO + FOLDING ARMS	D500 W520 H490 - 620	W500 H600	£373.00

Unlimited Fabric Available
Please call for pricing

FR: Med
Fabric: 100% Man-made
Mechanism: Asynchro / torsion / seat slide / lumbar pump / ratchet back

FABRIC FINISH



CALYPSO ERGO

2 YR COMPONENT GUARANTEE

2 YR UPHOLSTERY GUARANTEE

115 KG WEIGHT TOLERANCE

8 H HOURS USAGE

PHYSIO APPROVED

ERGONOMIC FEATURES TESTED AND APPROVED FOR OFFICE USE BY A QUALIFIED PHYSIOTHERAPIST

// NOTE: This chair is only physio approved when used with the 1D arm



	Seat Dimensions	Back Dimensions	RRP
CH2810 + AC1040 // CALYPSO ERGO + 1D ARMS	D470 W470 H470 - 600	W450 H500	£243.00
CH2810 + AC1082 // CALYPSO ERGO + FOLDING ARMS	D470 W470 H470 - 600	W450 H500	£260.00

Unlimited Fabric Available
Please call for pricing

FR: Med
Fabric: 100% Man-made
Mechanism: PCB / lumbar pump

FABRIC FINISHES // PU FINISH



EXECUTIVE SEATING

// 14

Need something a little fancier? You'll find it here with designs to add a touch of high end to your office without compromising on comfort or style.

CONTENTS

221	Pallas	228	Keno
221	Zeus	229	Ares
222	Cronos	229	Casino II
222	Montana	230	Canasta II
223	Whist	231	Jack II
224	Milan		
225	Flex		
226	Sosa		
227	Puma		
227	Baresi		



PALLAS

5YR
COMPONENT
GUARANTEE

2YR
UPHOLSTERY
GUARANTEE

115KG
WEIGHT
TOLERANCE

8H
HOURS
USAGE



- Contemporary executive style chair in bonded leather
- Lock-tilt mechanism with torsion control which is lockable in the upright position

	Seat Dimensions	Back Dimensions	RRP
CH3201 // PALLAS	D520 W490 H440 - 520	W490 H910	£398.00

FR: Low
Fabric: Bonded leather
Mechanism: Lock tilt
Arms: Fixed

FINISH
BK

ZEUS

5YR
COMPONENT
GUARANTEE

2YR
UPHOLSTERY
GUARANTEE

115KG
WEIGHT
TOLERANCE

8H
HOURS
USAGE



- Contemporary executive chair
- Asyncho mechanism with torsion control which is lockable in the upright position
- Large seat dimensions

	Seat Dimensions	Back Dimensions	RRP
CH3200 // ZEUS	D580 W570 H515 - 590	W620 H870	£450.00

FR: Med
Fabric: Leather look
Mechanism: Asyncho
Arms: Fixed

FINISH
BK

CRONOS

5 YR COMPONENT GUARANTEE | 2 YR UPHOLSTERY GUARANTEE | 115 KG WEIGHT TOLERANCE | 8 H HOURS USAGE



- Generously upholstered leather executive chair with silver detailing
- Sturdy fixed arms with comfy padding

	Seat Dimensions	Back Dimensions	RRP
CH3208 // CRONOS	D530 W560 H485 - 560	W530 H780	£330.00

FR: Med
Fabric: Leather faced
Mechanism: Lock-tilt / torsion
Arms: Fixed

FINISH
BK

WHIST

5 YR COMPONENT GUARANTEE | 2 YR UPHOLSTERY GUARANTEE | 115 KG WEIGHT TOLERANCE | 8 H HOURS USAGE



- Modern executive office chair
- Generously cushioned seat and back with distinctive stitching detail
- Lock tilt mechanism which is lockable in the upright position

	Seat Dimensions	Back Dimensions	RRP
CH0206 // LEATHER WHIST	D550 W570 H450 - 550	W530 H730	£429.00
CH3206 // FABRIC WHIST	D550 W570 H450 - 550	W530 H730	£298.00

CH0206
FR: Low
Fabric: Leather faced
Mechanism: Lock tilt / torsion
Arms: Fixed

CH3206
FR: Med
Fabric: 100% Man-made
Mechanism: Lock tilt / torsion
Arms: Fixed

LEATHER FINISH // FABRIC FINISHES
BK // RB BK

MONTANA

5 YR COMPONENT GUARANTEE | 2 YR UPHOLSTERY GUARANTEE | 115 KG WEIGHT TOLERANCE | 8 H HOURS USAGE



- Premium grade, leather faced, executive office chair
- Generously cushioned seat & back with a pronounced headrest & padded armrests
- Knee-tilt mechanism can be fixed in 5 different positions

	Seat Dimensions	Back Dimensions	RRP
CH0240 // MONTANA	D550 W540 H475 - 555	W520 H820	£450.00

FR: Low
Fabric: Leather faced
Mechanism: Knee-tilt 5 / torsion
Arms: Fixed

FINISH
BK

MILAN SWIVEL

5 YR COMPONENT GUARANTEE	2 YR UPHOLSTERY GUARANTEE	115 KG WEIGHT TOLERANCE	8 H HOURS USAGE
---------------------------------------	--	--------------------------------------	------------------------------



- Swivel chair on a chrome base with black castors
 - Available in a wide range of colours
- // NOTE: Stocked in black PU, made to order in unlimited Mirage fabric

	Seat Dimensions	Back Dimensions	RRP
CH7005 // MILAN SWIVEL	D420 W475 H395 - 525	W430 H395	£382.00

FR: Med
Fabric: Leather look / 100% Man-made
Mechanism: Lock tilt
Arms: Fixed

PU FINISH // FABRIC FINISH

BK //



FLEX MID BACK

5 YR COMPONENT GUARANTEE	2 YR UPHOLSTERY GUARANTEE	115 KG WEIGHT TOLERANCE	8 H HOURS USAGE
---------------------------------------	--	--------------------------------------	------------------------------



- Swivel chair on a polished aluminium base with black castors
- Breathable mesh back and polished fixed arms

	Seat Dimensions	Back Dimensions	RRP
CH1248 // FLEX MID BACK	D450 W490 H470 - 540	W470 H465	£463.00

FR: Low
Fabric: Mesh
Mechanism: Fixed
Arms: Fixed

FINISH

BK

FLEX HIGH BACK

5 YR COMPONENT GUARANTEE	2 YR UPHOLSTERY GUARANTEE	115 KG WEIGHT TOLERANCE	8 H HOURS USAGE
---------------------------------------	--	--------------------------------------	------------------------------



- High back swivel chair on a polished aluminium base with black castors
- Breathable mesh back and polished fixed arms

	Seat Dimensions	Back Dimensions	RRP
CH1247BK // FLEX HIGH BACK	D450 W490 H470 - 540	W470 H630	£483.00

FR: Low
Fabric: Mesh
Mechanism: Fixed
Arms: Fixed

FINISH

BK

SOSA

5 YR
COMPONENT
GUARANTEE

2 YR
UPHOLSTERY
GUARANTEE

115 KG
WEIGHT
TOLERANCE

8 H
HOURS
USAGE



- Soft-touch PU seat with chrome frame for style as well as comfort
- Lock tilt mechanism which is lockable in the upright position
- Tension control knob which can be adjusted to match the user's body weight

	Seat Dimensions	Back Dimensions	RRP
CH1249 // SOSA	D490 W530 H485 - 575	W465 H420	£191.00

FR: Med
Fabric: Leather look
Mechanism: Lock-tilt / torsion
Arms: Fixed

FINISH
BK



PUMA

5 YR
COMPONENT
GUARANTEE

2 YR
UPHOLSTERY
GUARANTEE

115 KG
WEIGHT
TOLERANCE

8 H
HOURS
USAGE



- Generously padded seat and back with a chrome base & height-adjustable arms
- Curved back to promote good posture and hug the user
- Asynchro mechanism enables complete customisation

	Seat Dimensions	Back Dimensions	RRP
CH1003 // PUMA	D470 W505 H490 - 610	W470 H525	£286.00

FR: Med
Fabric: Leather look
Mechanism: Asynchro
Arms: 1D adjustable

FINISH
BK

BARESI

5 YR
COMPONENT
GUARANTEE

2 YR
UPHOLSTERY
GUARANTEE

115 KG
WEIGHT
TOLERANCE

8 H
HOURS
USAGE



- Soft-touch PU seat with chrome frame for style as well as comfort
- Lock tilt mechanism which is lockable in the upright position
- Tension control knob which can be adjusted to match the user's body weight

	Seat Dimensions	Back Dimensions	RRP
CH0789 // BARESI	D450 W460 H450 - 540	W440 H560	286.00

FR: Med
Fabric: Leather look
Mechanism: Lock tilt / torsion
Arms: Fixed

FINISHES
BK WH

KENO LEATHER

5^{YR} COMPONENT GUARANTEE
 2^{YR} UPHOLSTERY GUARANTEE
 115^{KG} WEIGHT TOLERANCE
 8^H HOURS USAGE



- Generously upholstered executive style chair in a soft touch, leather
- Black nylon base with twin wheel hooded castors
- Lock tilt mechanism with torsion control which is lockable in the upright position

	Seat Dimensions	Back Dimensions	RRP
CH0237 // KENO LEATHER	D540 W550 H485 - 580	W550 H770	£254.00

FR: Med
 Fabric: Leather
 Mechanism: Lock tilt / torsion
 Arms: Fixed

FINISH
 BK

KENO FABRIC

5^{YR} COMPONENT GUARANTEE
 2^{YR} UPHOLSTERY GUARANTEE
 115^{KG} WEIGHT TOLERANCE
 8^H HOURS USAGE



- Generously upholstered executive style chair in tough wearing fabric
- Black nylon base with twin wheel hooded castors
- Lock tilt mechanism which is lockable in the upright position

	Seat Dimensions	Back Dimensions	RRP
CH0137 // KENO FABRIC	D540 W550 H485 - 580	W550 H770	£211.00

FR: Med
 Fabric: 100% Man-made
 Mechanism: Lock tilt / torsion
 Arms: Fixed

FABRIC FINISHES
 RB CH

ARES

5^{YR} COMPONENT GUARANTEE
 2^{YR} UPHOLSTERY GUARANTEE
 115^{KG} WEIGHT TOLERANCE
 8^H HOURS USAGE



- High back leather faced back for added comfort
- Chrome base and arm for modern, stylish appearance
- Detailed stitch line on seat/back

	Seat Dimensions	Back Dimensions	RRP
CH0270 // ARES	D530 W530 H495 - 550	W530 H770	£242.00

FR: Med
 Fabric: Leather look
 Mechanism: Knee-tilt 4 / torsion
 Arms: Fixed

FINISH
 BK

CASINO II

5^{YR} COMPONENT GUARANTEE
 2^{YR} UPHOLSTERY GUARANTEE
 115^{KG} WEIGHT TOLERANCE
 8^H HOURS USAGE



- Chrome base for stylish appearance
- Lock-tilt allows locking in upright position
- High back for added comfort and posture

	Seat Dimensions	Back Dimensions	RRP
CH0211 // CASINO II	D520 W530 H510 - 610	W520 H750	£201.00

FR: Med
 Fabric: Leather look
 Mechanism: Lock-tilt
 Arms: Fixed

FINISH
 BK

CANASTA II

2^{YR} COMPONENT GUARANTEE 2^{YR} UPHOLSTERY GUARANTEE 115^{KG} WEIGHT TOLERANCE 8^H HOURS USAGE



- High back leather look executive chair with a swivel base and fixed arms
- Stylish stitching detail
- Tension control knob which can be adjusted to match the user's body weight

	Seat Dimensions	Back Dimensions	RRP
CH0768 // CANASTA II LEATHER	D510 W520 H475 - 570	W520 H710	£167.00

FR: Med
Fabric: Leather look
Mechanism: Lock tilt / torsion
Arms: Fixed

FINISH
BK

CANASTA II FABRIC

2^{YR} COMPONENT GUARANTEE 2^{YR} UPHOLSTERY GUARANTEE 115^{KG} WEIGHT TOLERANCE 8^H HOURS USAGE



- High back fabric executive chair with a swivel base and fixed arms
- Stylish stitching detail
- Tension control knob which can be adjusted to match the user's body weight

	Seat Dimensions	Back Dimensions	RRP
CH0769 // CANASTA II FABRIC	D510 W520 H475 - 570	W520 H710	£167.00

FR: Med
Fabric: 100% Man-made
Mechanism: Lock tilt / torsion
Arms: Fixed

FABRIC FINISH
RB CH

JACK II

2^{YR} COMPONENT GUARANTEE 2^{YR} UPHOLSTERY GUARANTEE 115^{KG} WEIGHT TOLERANCE 8^H HOURS USAGE



- Professional looking PU executive chair with fixed arms
- Black nylon swivel base with twin wheel hooded castors
- Lock tilt mechanism which is lockable in the upright position

	Seat Dimensions	Back Dimensions	RRP
CH1765 // JACK II	D490 W480 H425 - 540	W480 H620	£144.00

FR: Med
Fabric: Leather look
Mechanism: Lock tilt
Arms: Fixed

FINISH
BK

JACK II FABRIC

2^{YR} COMPONENT GUARANTEE 2^{YR} UPHOLSTERY GUARANTEE 115^{KG} WEIGHT TOLERANCE 8^H HOURS USAGE



- Professional looking fabric executive chair with fixed arms
- Black nylon swivel base with twin wheel hooded castors
- Lock tilt mechanism which is lockable in the upright position

	Seat Dimensions	Back Dimensions	RRP
CH1765 // JACK II FABRIC	D490 W480 H425 - 540	W480 H620	£144.00

FR: Med
Fabric: 100% Man-made
Mechanism: Lock tilt
Arms: Fixed

FABRIC FINISH
RB CH

MEETING & CONFERENCE

// 15

Don't want to stray too far away from the classic meeting chair, but in need of something a bit 'more'? You'll find it here. With a range of meeting and conference chairs that take the mundane out of meetings. From a chrome cantilever frame, leather look finish, or even upholstered in your own choice of fabric- your conference room needn't conform ever again!

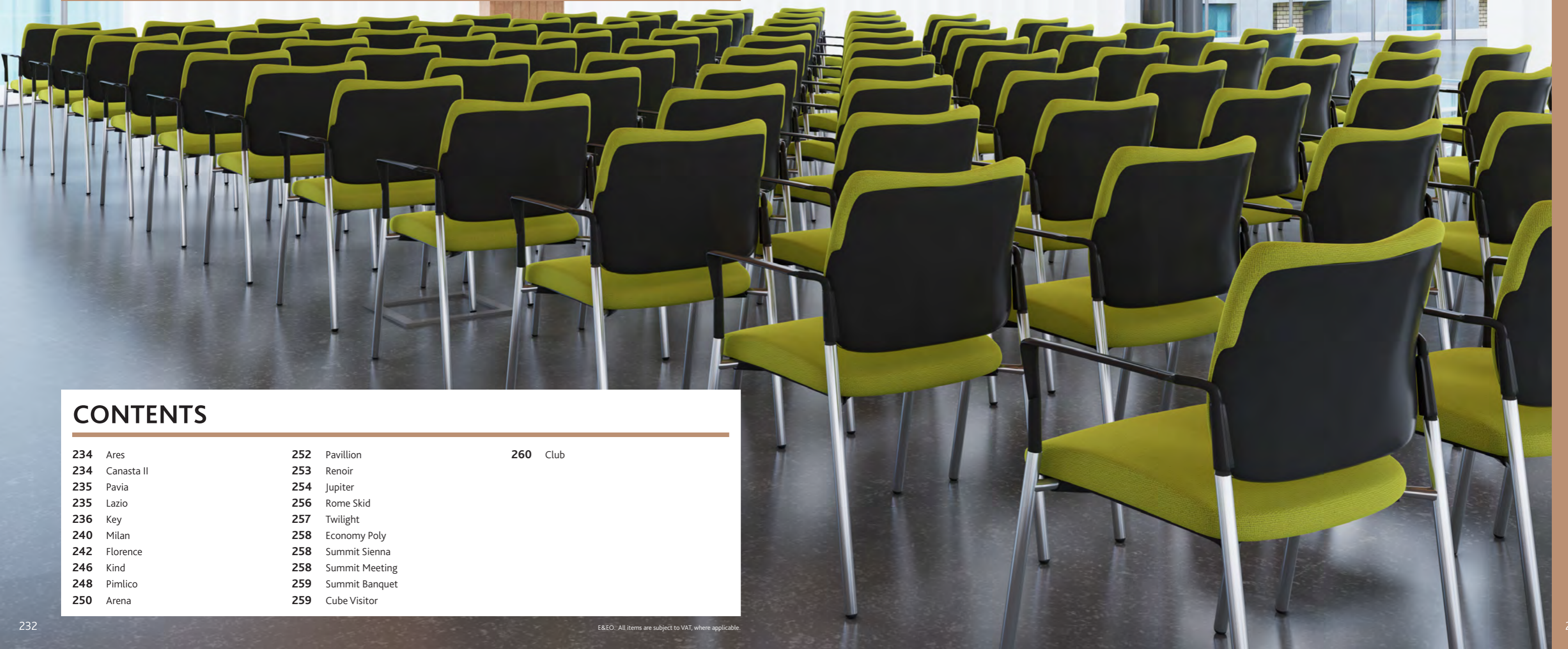

CONTENTS

234	Ares	252	Pavillion	260	Club
234	Canasta II	253	Renoir		
235	Pavia	254	Jupiter		
235	Lazio	256	Rome Skid		
236	Key	257	Twilight		
240	Milan	258	Economy Poly		
242	Florence	258	Summit Sienna		
246	Kind	258	Summit Meeting		
248	Pimlico	259	Summit Banquet		
250	Arena	259	Cube Visitor		

ARES CANTILEVER



- Leather look arm pad on chrome arm for modern, stylish appearance
- Visitor frame to suit any office space
- Detailed stitch line on seat/base

	Seat Dimensions	Back Dimensions	RRP
CH0271 // HIGH BACK VISITOR	D520 W510 H465	W530 H660	£201.00

Unlimited Fabric Available
Please call for pricing

FR: Medium
Fabric: Leather look
Arms: Fixed

FINISH

BK

2YR COMPONENT GUARANTEE	2YR UPHOLSTERY GUARANTEE	115 ^{KG} WEIGHT TOLERANCE	8 ^H HOURS USAGE
-------------------------------	--------------------------------	--	----------------------------------

PAVIA



- Professional looking visitor chairs to suit any office space
- Stylish chrome cantilever base with skid feet

	Seat Dimensions	Back Dimensions	RRP
CH2235 // PAVIA LEATHER	D460 W480 H455	W485 H470	£193.00
CH3235 // PAVIA FABRIC	D460 W480 H455	W485 H470	£193.00

FR: Med
Fabric: 100% Man-made / Leather look
Arms: Fixed

LEATHER FINISH // FABRIC FINISHES

BK // RB CH

5YR COMPONENT GUARANTEE	2YR UPHOLSTERY GUARANTEE	115 ^{KG} WEIGHT TOLERANCE	8 ^H HOURS USAGE
-------------------------------	--------------------------------	--	----------------------------------

CANASTA II



- Great value fabric or leather look visitor's chair with fixed arms
- Sturdy black powder-coated cantilever base
- Stylish stitching detail

	Seat Dimensions	Back Dimensions	RRP
CH0766 // CANASTA II LEATHER	D510 W510 H455	W510 H590	£177.00
CH0767 // CANASTA II FABRIC	D510 W510 H455	W510 H590	£177.00

FR: Med
Fabric: 100% Man-made / Leather look
Arms: Fixed

LEATHER FINISH // FABRIC FINISHES

BK // RB CH

2YR COMPONENT GUARANTEE	2YR UPHOLSTERY GUARANTEE	115 ^{KG} WEIGHT TOLERANCE	8 ^H HOURS USAGE
-------------------------------	--------------------------------	--	----------------------------------

LAZIO



- Generously cushioned meeting room chair
- Upholstered in soft touch, leather look, material
- Stackable up to 4 high for easy storage

	Seat Dimensions	Back Dimensions	RRP
CH0234 // LAZIO	D480 W460 H490	W450 H360	£134.00

FR: Med
Fabric: Leather look
Storage: Stack 4

FINISH

BK

5YR COMPONENT GUARANTEE	2YR UPHOLSTERY GUARANTEE	115 ^{KG} WEIGHT TOLERANCE	8 ^H HOURS USAGE
-------------------------------	--------------------------------	--	----------------------------------

KEY LOW BACK CANTILEVER

5^{YR} COMPONENT GUARANTEE	2^{YR} UPHOLSTERY GUARANTEE	115^{KG} WEIGHT TOLERANCE	8^H HOURS USAGE	MADE TO ORDER 25 DAYS
---	--	--	--	---



- Upholstered floating low back
- An ideal solution for conference, meeting and training environments
- Priced in Camira Advantage

	Seat Dimensions	Back Dimensions	RRP
KEY20B // LOW BACK BLACK FRAME	D450 W510 H450	W490 H430	£207.00 •
KEY20P // LOW BACK SILVER FRAME	D450 W510 H450	W490 H430	£207.00 •
KEY20C // LOW BACK CHROME FRAME	D450 W510 H450	W490 H430	POA •

FR: Low
Fabric: 100% Man-made
Arms: Fixed



// NOTE: Model Shown is KEY20C with Chrome Base. Product in Black Leather, price on application

KEY FULL BACK CANTILEVER

5^{YR} COMPONENT GUARANTEE	2^{YR} UPHOLSTERY GUARANTEE	115^{KG} WEIGHT TOLERANCE	8^H HOURS USAGE	MADE TO ORDER 25 DAYS
---	--	--	--	---



- Available in 3 frame colours
- Upholstered high back
- An ideal solution for conference, meeting and training environments
- Priced in Camira Advantage

	Seat Dimensions	Back Dimensions	RRP
KEY32B // FULL BACK BLACK FRAME	D450 W510 H450	W490 H430	£241.00 •
KEY32P // FULL BACK SILVER FRAME	D450 W510 H450	W490 H430	£241.00 •
KEY32C // FULL BACK CHROME FRAME	D450 W510 H450	W490 H430	POA •

FR: Low
Fabric: 100% Man-made
Stacks: 4
Arms: Fixed



// NOTE: Model Shown is KEY32C with Chrome Base

KEY LOW BACK STACKING CANTILEVER

5^{YR} COMPONENT GUARANTEE	2^{YR} UPHOLSTERY GUARANTEE	115^{KG} WEIGHT TOLERANCE	8^H HOURS USAGE	MADE TO ORDER 25 DAYS
---	--	--	--	---



- Upholstered floating low back
- An ideal solution for conference, meeting and training environments
- Stackable up to 4 high for easy storage
- Priced in Camira Advantage

	Seat Dimensions	Back Dimensions	RRP
KEY22B // STACKING BLACK FRAME	D450 W510 H450	W490 H430	£229.00 •
KEY22P // STACKING SILVER FRAME	D450 W510 H450	W490 H430	£229.00 •
KEY22C // STACKING CHROME FRAME	D450 W510 H450	W490 H430	POA •

FR: Low
Fabric: 100% Man-made
Stacks: 4
Arms: Fixed



// NOTE: Model Shown is KEY22C with Chrome Base



KEY LOW BACK 4 LEG ARMCHAIR

5YR COMPONENT GUARANTEE	2YR UPHOLSTERY GUARANTEE	115KG WEIGHT TOLERANCE	8H HOURS USAGE	MADE TO ORDER 25 DAYS
--------------------------------------	---------------------------------------	-------------------------------------	-----------------------------	---



- Upholstered floating low back
- An ideal solution for conference, meeting and training environments
- Priced in Camira Advantage

	Seat Dimensions	Back Dimensions	RRP
KEY21B // ARMCHAIR BLACK FRAME	D450 W510 H450	W490 H430	£213.00 •
KEY21P // ARMCHAIR SILVER FRAME	D450 W510 H450	W490 H430	£213.00 •
KEY21C // ARMCHAIR CHROME FRAME	D450 W510 H450	W490 H430	POA •

FR: Low
Fabric: 100% Man-made
Arms: Fixed



// NOTE: Model Shown is KEY21C with Chrome Base (C) Option

KEY LOW BACK SWIVEL CHAIR

5YR COMPONENT GUARANTEE	2YR UPHOLSTERY GUARANTEE	115KG WEIGHT TOLERANCE	8H HOURS USAGE	MADE TO ORDER 25 DAYS
--------------------------------------	---------------------------------------	-------------------------------------	-----------------------------	---



- Upholstered floating low back
- Polished 4 star aluminium base with black nylon glides
- An ideal solution for conference, meeting and training environments
- Priced in Camira Advantage

	Seat Dimensions	Back Dimensions	RRP
KEY23C // LOW BACK SWIVEL CHAIR	D450 W510 H460	W490 H430	£366.00 •
KEY23C + 5S // BASE WITH CASTORS & GAS LIFT	D450 W510 H460	W490 H430	POA •
KEY23C + AT // AUTO RETURN SEAT, GAS LIFT & GLIDE	D450 W510 H460	W490 H430	POA •

FR: Low
Fabric: 100% Man-made
Arms: Fixed



// NOTE: Model shown is KEY23C

KEY FULL BACK 4 LEG ARMCHAIR

5YR COMPONENT GUARANTEE	2YR UPHOLSTERY GUARANTEE	115KG WEIGHT TOLERANCE	8H HOURS USAGE	MADE TO ORDER 25 DAYS
--------------------------------------	---------------------------------------	-------------------------------------	-----------------------------	---



- Upholstered low back
- An ideal solution for conference, meeting and training environments
- Priced in Camira Advantage

	Seat Dimensions	Back Dimensions	RRP
KEY31B // ARMCHAIR BLACK FRAME	D450 W510 H450	W490 H430	£226.00 •
KEY31P // ARMCHAIR SILVER FRAME	D450 W510 H450	W490 H430	£226.00 •
KEY31C // ARMCHAIR CHROME FRAME	D450 W510 H450	W490 H430	POA •

FR: Low
Fabric: 100% Man-made
Arms: Fixed



// NOTE: Model Shown is KEY31C with Chrome Base (C) Option

KEY FULL BACK SWIVEL CHAIR

5YR COMPONENT GUARANTEE	2YR UPHOLSTERY GUARANTEE	115KG WEIGHT TOLERANCE	8H HOURS USAGE	MADE TO ORDER 25 DAYS
--------------------------------------	---------------------------------------	-------------------------------------	-----------------------------	---



- Upholstered full back
- Polished 4 star aluminium base with black nylon glides
- An ideal solution for conference, meeting and training environments
- Priced in Camira Advantage

	Seat Dimensions	Back Dimensions	RRP
KEY33C // FULL BACK SWIVEL CHAIR	D450 W510 H460	W490 H430	£432.00 •
KEY33C + 5S // BASE WITH CASTORS & GAS LIFT	D450 W510 H460	W490 H430	POA •
KEY33C + AT // AUTO RETURN SEAT, GAS LIFT & GLIDE	D450 W510 H460	W490 H430	POA •

FR: Low
Fabric: 100% Man-made
Arms: Fixed



// NOTE: Model shown is KEY33C

MILAN CONFERENCE

5^{YR} COMPONENT GUARANTEE
 2^{YR} UPHOLSTERY GUARANTEE
 115^{KG} WEIGHT TOLERANCE
 8^H HOURS USAGE



- Swivel chair on a chrome base
- Available in a wide range of seat colours

// NOTE: Stocked in PU, unlimited in Mirage fabric

	Seat Dimensions	Back Dimensions	RRP
CH7008 // MILAN 4 STAR	D420 W470 H470	W435 H400	£402.00

Unlimited Fabric Available
 Please call for pricing

FR: Med
 Fabric: Leather look / 100% Man-made

PU FINISH // FABRIC FINISH
 BK //

MILAN SKID

5^{YR} COMPONENT GUARANTEE
 2^{YR} UPHOLSTERY GUARANTEE
 115^{KG} WEIGHT TOLERANCE
 8^H HOURS USAGE



- Visitor chair frame with skid feet
- Available in a wide range of seat colours

// NOTE: Stocked in PU, unlimited in Mirage fabric

	Seat Dimensions	Back Dimensions	RRP
CH7006 // MILAN SKID BASE	D425 W475 H465	W435 H385	£277.00

Unlimited Fabric Available
 Please call for pricing

FR: Med
 Fabric: Leather look / 100% Man-made

PU FINISH // FABRIC FINISH
 BK //

MILAN 4-LEG

5^{YR} COMPONENT GUARANTEE
 2^{YR} UPHOLSTERY GUARANTEE
 115^{KG} WEIGHT TOLERANCE
 8^H HOURS USAGE



- Chrome 4 leg frame
- Available in a wide range of seat colours

// NOTE: Stocked in PU, unlimited in Mirage fabric

	Seat Dimensions	Back Dimensions	RRP
CH7007 // MILAN 4-LEG	D425 W480 H460	W435 H365	£262.00

Unlimited Fabric Available
 Please call for pricing

FR: Med
 Fabric: Leather look / 100% Man-made

PU FINISH // FABRIC FINISH
 BK //

MILAN BAR STOOL

5^{YR} COMPONENT GUARANTEE
 2^{YR} UPHOLSTERY GUARANTEE
 115^{KG} WEIGHT TOLERANCE
 8^H HOURS USAGE



- High bar stool with skid feet
- Available in a wide range of seat colours

// NOTE: Stocked in PU, unlimited in Mirage fabric

	Seat Dimensions	Back Dimensions	RRP
CH7004 // MILAN BAR STOOL	D370 W410 H760	W390 H205	£262.00

Unlimited Fabric Available
 Please call for pricing

FR: Med
 Fabric: Leather look / 100% Man-made

PU FINISH // FABRIC FINISH
 BK //

FLORENCE CHROME SIDE CHAIR

5 YR COMPONENT GUARANTEE	2 YR UPHOLSTERY GUARANTEE	115 KG WEIGHT TOLERANCE	8 H HOURS USAGE
---------------------------------------	--	--------------------------------------	------------------------------



- Conference seating range available in a huge selection of colours and fabrics
- Stylish chrome frames ensure these chairs look good through heavy usage
- Plastic skid feet for stability and to avoid floor marking

// **NOTE:** Stocked in black fabric

	Seat Dimensions	Back Dimensions	RRP
CH3511 // CHROME SIDE CHAIR	D470 W460 H450	W440 H300	£198.00

Unlimited Fabric Available
Please call for pricing

FR: Med
Fabric: 100% Man-made
Storage: Stacks 4

FABRIC FINISH
BK

FLORENCE CHROME ARMCHAIR

5 YR COMPONENT GUARANTEE	2 YR UPHOLSTERY GUARANTEE	115 KG WEIGHT TOLERANCE	8 H HOURS USAGE
---------------------------------------	--	--------------------------------------	------------------------------



- Conference seating range available in a huge selection of colours and fabrics
- Stylish chrome frames ensure these chairs look good through heavy usage
- Plastic skid feet for stability and to avoid floor marking

// **NOTE:** Stocked in black fabric

	Seat Dimensions	Back Dimensions	RRP
CH3509 // CHROME ARMCHAIR	D470 W460 H450	W440 H300	£222.00

Unlimited Fabric Available
Please call for pricing

FR: Med
Fabric: 100% Man-made
Storage: Stacks 4
Arms: Fixed

FABRIC FINISH
BK



KIND VISITOR CHAIR

5YR COMPONENT GUARANTEE	2YR UPHOLSTERY GUARANTEE	115KG WEIGHT TOLERANCE	8-10^H HOURS USAGE	MADE TO ORDER 25 DAYS
--------------------------------------	---------------------------------------	-------------------------------------	---	---



- Upholstered seat & back
- Black plastic outer back & under shroud
- Perfect solution for all boardroom, training and conference applications

	Seat Dimensions	Back Dimensions	RRP
KDMC01B // VISITOR WITH BLACK FRAME	D470 W450 H500	W450 H350	£187.00 •
KDMC01P // VISITOR WITH SILVER FRAME	D470 W450 H500	W450 H350	£187.00 •
KDMC01C // VISITOR WITH CHROME FRAME	D470 W450 H500	W450 H350	POA •
KDCS // CASTORS			£26.00 •

FR: Low
Fabric: 100% Man-made
Storage: Stacks 4



// NOTE: Model Shown is KDMC01C with Chrome Base (C) Option

KIND MESH BACK CHAIR

5YR COMPONENT GUARANTEE	2YR UPHOLSTERY GUARANTEE	115KG WEIGHT TOLERANCE	8-10^H HOURS USAGE	MADE TO ORDER 25 DAYS
--------------------------------------	---------------------------------------	-------------------------------------	---	---



- Upholstered seat & mesh back
- Perfect solution for all boardroom, training and conference applications

	Seat Dimensions	Back Dimensions	RRP
KDMC21B // VISITOR WITH BLACK FRAME	D470 W450 H500	W450 H350	£180.00 •
KDMC21P // VISITOR WITH SILVER FRAME	D470 W450 H500	W450 H350	£180.00 •
KDMC21C // VISITOR WITH CHROME FRAME	D470 W450 H500	W450 H350	POA •
KDCS // CASTORS			£26.00 •

FR: Low
Fabric: Mesh / 100% Man-made
Storage: Stacks 4



// NOTE: Model Shown is KDMC21C with Chrome Base (C) Option

KIND VISITOR ARMCHAIR

5YR COMPONENT GUARANTEE	2YR UPHOLSTERY GUARANTEE	115KG WEIGHT TOLERANCE	8-10^H HOURS USAGE	MADE TO ORDER 25 DAYS
--------------------------------------	---------------------------------------	-------------------------------------	---	---



- Upholstered seat & back
- Black plastic outer back & under shroud
- Perfect solution for all boardroom, training and conference applications

	Seat Dimensions	Back Dimensions	RRP
KDMC02B // ARMCHAIR WITH BLACK FRAME	D470 W450 H500	W450 H350	£223.00 •
KDMC02P // ARMCHAIR WITH SILVER FRAME	D470 W450 H500	W450 H350	£223.00 •
KDMC02C // ARMCHAIR WITH CHROME FRAME	D470 W450 H500	W450 H350	POA •
KDCS // CASTORS			£26.00 •

FR: Low
Fabric: 100% Man-made
Arms: Fixed
Storage: Stacks 4



// NOTE: Model Shown is KDMC02C with Chrome Base (C) Option

KIND MESH BACK ARMCHAIR

5YR COMPONENT GUARANTEE	2YR UPHOLSTERY GUARANTEE	115KG WEIGHT TOLERANCE	8^H HOURS USAGE	MADE TO ORDER 25 DAYS
--------------------------------------	---------------------------------------	-------------------------------------	--	---



- Upholstered seat & mesh back
- Black plastic outer back & under shroud
- Perfect solution for all boardroom, training and conference applications

	Seat Dimensions	Back Dimensions	RRP
KDMC22B // ARMCHAIR WITH BLACK FRAME	D470 W450 H500	W450 H350	£215.00 •
KDMC22P // ARMCHAIR WITH SILVER FRAME	D470 W450 H500	W450 H350	£215.00 •
KDMC22C // ARMCHAIR WITH CHROME FRAME	D470 W450 H500	W450 H350	POA •
KDCS // CASTORS			£26.00 •

FR: Low
Fabric: Mesh / 100% Man-made
Arms: Fixed
Storage: Stacks 4



// NOTE: Model Shown is KDMC22C with Chrome Base (C) Option

PIMLICO 4 LEG

5 YR COMPONENT GUARANTEE	115 KG WEIGHT TOLERANCE	8 H HOURS USAGE	MADE TO ORDER 25 DAYS
---------------------------------------	--------------------------------------	------------------------------	--------------------------------



- One piece shell
- Extreme comfort and durability
- Stacks up to 6 high
- Available in graphite, blue, white, yellow or orange shells

	Seat Dimensions	Back Dimensions	RRP
PM-01 // PLASTIC SEAT & NO ARMS	D530 W530 H470	W430 H340	£167.00 •
PM-02 // PLASTIC SEAT & FIXED ARMS	D530 W530 H470	W430 H340	£173.00 •

FR: Low
Arms: Fixed

SHELL FINISHES

GP	BL	WH	YL	OR
----	----	----	----	----

PIMLICO SLED

5 YR COMPONENT GUARANTEE	115 KG WEIGHT TOLERANCE	8 H HOURS USAGE	MADE TO ORDER 25 DAYS
---------------------------------------	--------------------------------------	------------------------------	--------------------------------



- One piece shell
- Extreme comfort and durability
- Stacks up to 6 high
- Available in graphite, blue, white, yellow or orange shells

	Seat Dimensions	Back Dimensions	RRP
PM-05 // PLASTIC SEAT & NO ARMS	D530 W530 H470	W430 H340	£172.00 •
PM-06 // PLASTIC SEAT & FIXED ARMS	D530 W530 H470	W430 H340	£179.00 •

FR: Low

SHELL FINISHES

GP	BL	WH	YL	OR
----	----	----	----	----

PIMLICO UPHOLSTERED 4 LEG

5 YR COMPONENT GUARANTEE	2 YR UPHOLSTERY GUARANTEE	115 KG WEIGHT TOLERANCE	8 H HOURS USAGE	MADE TO ORDER 25 DAYS
---------------------------------------	--	--------------------------------------	------------------------------	--------------------------------



- One piece shell
- Extreme comfort and durability
- Stacks up to 6 high
- Available in graphite, blue, white, yellow or orange shells

	Seat Dimensions	Back Dimensions	RRP
PM-03 // UPHOLSTERED & NO ARMS	D530 W530 H470	W430 H340	£193.00 •
PM-04 // UPHOLSTERED & FIXED ARMS	D530 W530 H470	W430 H340	£200.00 •

FR: Low
Fabric: 100% Man-made

SHELL FINISHES // SEAT FINISH

GP	BL	WH	YL	OR	//	
----	----	----	----	----	----	--

PIMLICO UPHOLSTERED SLED

5 YR COMPONENT GUARANTEE	2 YR UPHOLSTERY GUARANTEE	115 KG WEIGHT TOLERANCE	8 H HOURS USAGE	MADE TO ORDER 25 DAYS
---------------------------------------	--	--------------------------------------	------------------------------	--------------------------------



- One piece shell
- Extreme comfort and durability
- Stacks up to 6 high
- Available in graphite, blue, white, yellow or orange shells

	Seat Dimensions	Back Dimensions	RRP
PM-07 // UPHOLSTERED & NO ARMS	D530 W530 H470	W430 H340	£198.00 •
PM-08 // UPHOLSTERED & FIXED ARMS	D530 W530 H470	W430 H340	£207.00 •

FR: Low
Fabric: 100% Man-made
Arms: Fixed

SHELL FINISHES // SEAT FINISH

GP	BL	WH	YL	OR	//	
----	----	----	----	----	----	--

• Refer to trade price list. E&EO. All items are subject to VAT, where applicable.

ARENA CANTILEVER

5^{YR} COMPONENT GUARANTEE	2^{YR} UPHOLSTERY GUARANTEE	115^{KG} WEIGHT TOLERANCE	8^H HOURS USAGE	MADE TO ORDER 25 DAYS
---	--	--	--	---



- Designed for conference rooms, meeting areas and offices

	Seat Dimensions	Back Dimensions	RRP
AR3B // CANTILEVER WITH BLACK FRAME	D450 W460 H450	W520 H420	£126.00 •
AR3P // CANTILEVER WITH SILVER FRAME	D450 W460 H450	W520 H420	£126.00 •
AR3C // CANTILEVER WITH CHROME FRAME	D450 W460 H450	W520 H420	POA •
WTR // RIGHT HAND WRITING TABLET			£83.00 •
WTL // LEFT HAND WRITING TABLET			£83.00 •

FR: Low
Fabric: 100% Man-made



// NOTE: Model Shown is AR3C with Chrome Base

ARENA 4 LEG

5^{YR} COMPONENT GUARANTEE	2^{YR} UPHOLSTERY GUARANTEE	115^{KG} WEIGHT TOLERANCE	8^H HOURS USAGE	MADE TO ORDER 25 DAYS
---	--	--	--	---



- Designed for conference rooms, meeting areas and offices

	Seat Dimensions	Back Dimensions	RRP
AR1B // 4-LEG WITH BLACK FRAME	D450 W460 H450	W460 H420	£126.00 •
AR1P // 4-LEG WITH SILVER FRAME	D450 W460 H450	W460 H420	£126.00 •
AR1C // 4-LEG WITH CHROME FRAME	D450 W460 H450	W460 H420	POA •
CS // CASTORS			POA •
WTR // RIGHT HAND WRITING TABLET			£83.00 •
WTL // LEFT HAND WRITING TABLET			£83.00 •

FR: Low
Fabric: 100% Man-made
Storage: Stacks 4 (cannot be stacked with writing tablet option)



// NOTE: Model Shown is AR1B with Chrome Base (C) Option

ARENA CANTILEVER ARMCHAIR

5^{YR} COMPONENT GUARANTEE	2^{YR} UPHOLSTERY GUARANTEE	115^{KG} WEIGHT TOLERANCE	8^H HOURS USAGE	MADE TO ORDER 25 DAYS
---	--	--	--	---



- Designed for conference rooms, meeting areas and offices

	Seat Dimensions	Back Dimensions	RRP
AR4B // CANTILEVER WITH BLACK FRAME	D450 W460 H450	W460 H420	£171.00 •
AR4P // CANTILEVER WITH SILVER FRAME	D450 W460 H450	W460 H420	£171.00 •
AR4C // CANTILEVER WITH CHROME FRAME	D450 W460 H450	W460 H420	POA •
WTR // RIGHT HAND WRITING TABLET			£83.00 •
WTL // LEFT HAND WRITING TABLET			£83.00 •

FR: Low
Fabric: 100% Man-made
Arms: Fixed



// NOTE: Model Shown is AR4C with Chrome Base

ARENA 4 LEG ARMCHAIR

5^{YR} COMPONENT GUARANTEE	2^{YR} UPHOLSTERY GUARANTEE	115^{KG} WEIGHT TOLERANCE	8^H HOURS USAGE	MADE TO ORDER 25 DAYS
---	--	--	--	---



- Designed for conference rooms, meeting areas and offices

	Seat Dimensions	Back Dimensions	RRP
AR2B // 4-LEG WITH BLACK FRAME	D450 W460 H450	W460 H420	£171.00 •
AR2P // 4-LEG WITH SILVER FRAME	D450 W460 H450	W460 H420	£171.00 •
AR2C // 4-LEG WITH CHROME FRAME	D450 W460 H450	W460 H420	POA •
CS // CASTORS			POA •
WTR // RIGHT HAND WRITING TABLET			£83.00 •
WTL // LEFT HAND WRITING TABLET			£83.00 •

FR: Low
Fabric: 100% Man-made
Arms: Fixed
Storage: Stacks 4 (cannot be stacked with writing tablet option)



// NOTE: Model Shown is AR2B with Chrome Base (C) Option

PAVILION ARMCHAIR

5^{YR} COMPONENT GUARANTEE
 2^{YR} UPHOLSTERY GUARANTEE
 115^{KG} WEIGHT TOLERANCE
 8^H HOURS USAGE



- Sturdy chrome frame
- Plastic skid feet for stability and to avoid floor marking
- Leather look

	Seat Dimensions	Back Dimensions	RRP
CH0529 // PU ARMCHAIR	D450 W470 H470	W470 H365	£222.00

FR: Med
 Fabric: Leather look
 Storage: Stacks 3
 Arms: Fixed

FINISH



PAVILION SIDE CHAIR

5^{YR} COMPONENT GUARANTEE
 2^{YR} UPHOLSTERY GUARANTEE
 115^{KG} WEIGHT TOLERANCE
 8^H HOURS USAGE



- Sturdy chrome frame
- Plastic skid feet for stability and to avoid floor marking

	Seat Dimensions	Back Dimensions	RRP
CH0528 // PU SIDE CHAIR	D450 W470 H470	W470 H365	£186.00
CH0527 // FABRIC SIDE CHAIR	D450 W470 H470	W470 H365	£186.00

FR: Med
 Fabric: Leather look / 100% Man-made
 Storage: Stacks 3

PU FINISH // FABRIC FINISHES



RENOIR SIDE CHAIR

2^{YR} COMPONENT GUARANTEE
 2^{YR} UPHOLSTERY GUARANTEE
 115^{KG} WEIGHT TOLERANCE
 8^H HOURS USAGE



- Stylish wood framed chair suitable for conference rooms, reception areas and waiting rooms
- Generously upholstered seat and back
- Polished wood frame

	Seat Dimensions	Back Dimensions	RRP
CH0705 // SIDE CHAIR	D500 W410 H470	W400 H300	£139.00

Unlimited Fabric Available

Please call for pricing

FR: Med
 Fabric: 100% Man-made
 Storage: Stacks 4

FABRIC FINISHES



RENOIR ARMCHAIR

2^{YR} COMPONENT GUARANTEE
 2^{YR} UPHOLSTERY GUARANTEE
 115^{KG} WEIGHT TOLERANCE
 8^H HOURS USAGE



- Stylish wood framed armchair suitable for conference rooms, reception areas and waiting rooms
- Generously upholstered seat and back
- Polished wood frame

	Seat Dimensions	Back Dimensions	RRP
CH0706 // ARMCHAIR	D505 W465 H470	W400 H290	£139.00

Unlimited Fabric Available

Please call for pricing

FR: Med
 Fabric: 100% Man-made
 Storage: Stacks 4

FABRIC FINISH



JUPITER CHROME SIDE CHAIR

5 YR COMPONENT GUARANTEE
2 YR UPHOLSTERY GUARANTEE
115 KG WEIGHT TOLERANCE
8 H HOURS USAGE



- A stylish family of mesh-backed conference seating
- Curved mesh back for comfort
- Plastic skid feet for stability and to avoid floor marking

	Seat Dimensions	Back Dimensions	RRP
CH0785 // CHROME SIDE CHAIR	D460 W465 H485	W450 H300	£101.00

Unlimited Fabric Available
Please call for pricing

FR: Low
Fabric: Mesh / 100% Man-made
Storage: Stacks 4



JUPITER SIDE CHAIR

5 YR COMPONENT GUARANTEE
2 YR UPHOLSTERY GUARANTEE
115 KG WEIGHT TOLERANCE
8 H HOURS USAGE



- A stylish family of mesh-backed conference seating with a black frame
- Curved mesh back for comfort
- Plastic skid feet for stability and to avoid floor marking

	Seat Dimensions	Back Dimensions	RRP
CH0787 // SIDE CHAIR	D460 W465 H485	W450 H300	£90.00

Unlimited Fabric Available
Please call for pricing

FR: Low
Fabric: Mesh / 100% Man-made
Storage: Stacks 4



JUPITER CHROME ARMCHAIR

5 YR COMPONENT GUARANTEE
2 YR UPHOLSTERY GUARANTEE
115 KG WEIGHT TOLERANCE
8 H HOURS USAGE



- A stylish family of mesh-backed conference seating
- Curved mesh back for comfort
- Plastic skid feet for stability and to avoid floor marking

	Seat Dimensions	Back Dimensions	RRP
CH0784 // CHROME ARMCHAIR	D460 W465 H485	W450 H300	£112.00

Unlimited Fabric Available
Please call for pricing

FR: Low
Fabric: Mesh / 100% Man-made
Storage: Stacks 4
Arms: Fixed



JUPITER ARMCHAIR

5 YR COMPONENT GUARANTEE
2 YR UPHOLSTERY GUARANTEE
115 KG WEIGHT TOLERANCE
8 H HOURS USAGE



- A stylish family of mesh-backed conference seating with a black frame
- Curved mesh back for comfort
- Plastic skid feet for stability and to avoid floor marking

	Seat Dimensions	Back Dimensions	RRP
CH0786 // ARMCHAIR	D460 W465 H485	W450 H300	£101.00

Unlimited Fabric Available
Please call for pricing

FR: Low
Fabric: Mesh / 100% Man-made
Storage: Stacks 4
Arms: Fixed



ROME SKID ARMCHAIR

5^{YR}
COMPONENT
GUARANTEE

115^{KG}
WEIGHT
TOLERANCE

8^H
HOURS
USAGE



- An armchair with clean angular styling and built-in arms
- Hard-wearing polypropylene seat and back with a chrome skid frame
- Clear plastic feet to avoid floor marking

	Seat Dimensions	Back Dimensions	RRP
CH7002 // ROME SKID ARMCHAIR	D455 W465 H460	W460 H325	£111.00

FR: Low
Material: Polypropylene
Arms: Fixed
Storage: Stacks 5

FINISHES



ROME SKID SIDE CHAIR

5^{YR}
COMPONENT
GUARANTEE

115^{KG}
WEIGHT
TOLERANCE

8^H
HOURS
USAGE



- A side chair with clean angular styling and a skid base
- Hard-wearing polypropylene seat and back with a chrome skid frame
- Clear plastic feet to avoid floor marking

	Seat Dimensions	Back Dimensions	RRP
CH7003 // ROME SKID SIDE CHAIR	D455 W465 H460	W460 H325	£91.00

FR: Low
Material: Polypropylene
Storage: Stacks 5

FINISHES



TWILIGHT

2^{YR}
COMPONENT
GUARANTEE

115^{KG}
WEIGHT
TOLERANCE

5^H
HOURS
USAGE



- Wipe clean, polypropylene seat and back
- Supplied with integrated linking feet as standard
- Stackable up to 4 high or 25 high on a trolley

	Seat Dimensions	Back Dimensions	RRP
CH0507 // TWILIGHT	D440 W425 H440	W460 H245	£122.00
AC0508 // TWILIGHT TROLLEY	25 chairs		£303.00

FR: Low
Materials: Polypropylene
Storage: Stacks 25

FINISH



TWILIGHT + WRITING TABLET

2^{YR}
COMPONENT
GUARANTEE

115^{KG}
WEIGHT
TOLERANCE

5^H
HOURS
USAGE



- Wipe clean, polypropylene seat and back
- Supplied with integrated linking feet as standard
- Folding, adjustable arm tablet

	Seat Dimensions	RRP
CH0507 + AC0507 // TWILIGHT + WRITING TABLET	D250 W290	£181.00

FR: Low
Materials: Polypropylene

FINISH



ECONOMY POLY



- High fabric back with handle to aid easy setup and movement
- Powder-coated black metal frame

	Seat Dimensions	Back Dimensions	RRP
ECOPLY // ECONOMY POLY	D365 W440 H460	W440 H240	£34.00

FR: Med
Fabric:
Storage: Stacks 4

FINISHES



5^{YR}
COMPONENT
GUARANTEE

115^{KG}
WEIGHT
TOLERANCE

5^H
HOURS
USAGE

SUMMIT SIENNA



- Robust folding chairs ideal for schools, private and public sectors
- Upholstered back and seat
- Sturdy black metal frame with easy carrying handle

	Seat Dimensions	Back Dimensions	RRP
CH1519 // SUMMIT SIENNA	D420 W420 H480	W420 H230	£117.00

FR: Med
Fabric: 100% Man-made

FABRIC FINISH



2^{YR}
COMPONENT
GUARANTEE

2^{YR}
UPHOLSTERY
GUARANTEE

115^{KG}
WEIGHT
TOLERANCE

8^H
HOURS
USAGE

SUMMIT MEETING



- Cushioned seat and back for added comfort
- Chrome cantilever frame

	Seat Dimensions	Back Dimensions	RRP
CH0501 // SUMMIT MEETING	D460 W490 H510	W480 H325	£155.00

FR: Med
Fabric: 100% Man-made
Storage: Stacks 4

FABRIC FINISH



2^{YR}
COMPONENT
GUARANTEE

2^{YR}
UPHOLSTERY
GUARANTEE

115^{KG}
WEIGHT
TOLERANCE

8^H
HOURS
USAGE

SUMMIT BANQUET



- High fabric back with handle to aid easy setup and movement
- Powder-coated black metal frame

	Seat Dimensions	Back Dimensions	RRP
CH0519 // SUMMIT BANQUET	D390 W405 H475	W330 H310	£71.00

FR: Med
Fabric: 100% Man-made
Storage: Stacks 4

FABRIC FINISH



2^{YR}
COMPONENT
GUARANTEE

2^{YR}
UPHOLSTERY
GUARANTEE

115^{KG}
WEIGHT
TOLERANCE

8^H
HOURS
USAGE

CUBE VISITOR



- Robust chairs ideal for schools, private and public sectors
- Upholstered back and seat
- Sturdy black metal frame

	Seat Dimensions	Back Dimensions	RRP
CH0541 // CUBE VISITOR	D415 W410 H480	W410 H185	£91.00

FR: Med
Fabric: 100% Man-made

FABRIC FINISH



2^{YR}
COMPONENT
GUARANTEE

2^{YR}
UPHOLSTERY
GUARANTEE

115^{KG}
WEIGHT
TOLERANCE

5^H
HOURS
USAGE

CUBE HIGH



- Cushioned seat and back for added comfort
- Black frame

	Seat Dimensions	Back Dimensions	RRP
CH0540 // CUBE HIGH	D410 W410 H700	W410 H185	£191.00

FR: Med
Fabric: 100% Man-made

FABRIC FINISH // PU FINISH



2^{YR}
COMPONENT
GUARANTEE

2^{YR}
UPHOLSTERY
GUARANTEE

115^{KG}
WEIGHT
TOLERANCE

5^H
HOURS
USAGE

CLUB

5^{YR} COMPONENT GUARANTEE | 2^{YR} UPHOLSTERY GUARANTEE | 115^{KG} WEIGHT TOLERANCE | 8^H HOURS USAGE



- Cushioned seat and back for added comfort
- Robust black frame
- Available in 8 stocked finishes & unlimited fabrics

	Seat Dimensions	Back Dimensions	RRP
CH0500 // CLUB	D420 W480 H485	W485 H350	£71.00
CH0500PU // CLUB PU	D420 W480 H485	W485 H350	£77.00

Unlimited Fabric Available
Please call for pricing

FR: Med
Fabric: 100%
Man-made
Storage: Stacks 4

FABRIC FINISHES // PU FINISHES

RB CH CL BK GN RD // BL BK

CLUB WOOD

5^{YR} COMPONENT GUARANTEE | 115^{KG} WEIGHT TOLERANCE | 8^H HOURS USAGE



- Light wooden back and seat
- Robust chrome frame
- Plastic skid feet for stability and to avoid floor marking

	Seat Dimensions	Back Dimensions	RRP
CH1505 // CLUB WOOD	D420 W465 H445	W465 H340	£96.00

FR: Low
Material: Wood veneer
Storage: Stacks 8

FINISH

BE

CLUB CHROME

5^{YR} COMPONENT GUARANTEE | 2^{YR} UPHOLSTERY GUARANTEE | 115^{KG} WEIGHT TOLERANCE | 8^H HOURS USAGE



- Cushioned seat and back for added comfort
- Robust chrome frame
- Available in 8 stocked finishes & unlimited fabrics

	Seat Dimensions	Back Dimensions	RRP
CH0503 // CLUB CHROME	D420 W480 H485	W485 H350	£73.00
CH0503PU // CLUB CHROME PU	D420 W480 H485	W485 H350	£79.00

Unlimited Fabric Available
Please call for pricing

FR: Med
Fabric: 100%
Man-made
Storage: Stacks 4

FABRIC FINISHES // PU FINISHES

RB CH CL BK GN RD // BL BK

CLUB CANTEEN

5^{YR} COMPONENT GUARANTEE | 115^{KG} WEIGHT TOLERANCE | 8^H HOURS USAGE



- Wipe clean, polypropylene seat and back
- Robust, powder coated, black frame

	Seat Dimensions	Back Dimensions	RRP
CH0506 // CLUB CANTEEN	D390 W460 H450	W470 H320	£71.00

FR: Low
Material: Polypropylene
Storage: Stacks 8

FINISHES

BL BK

OPERATOR SEATING

// 16

This range of chairs allows you to operate to your fullest ability. Designed with practicality in mind, they are easy to use and support operational workers while maintaining a level of style and comfort.



CONTENTS

- 264 Topaz
- 268 Concept
- 270 Calypso
- 272 Typist
- 272 Zoom
- 274 Lapis Perch
- 274 Sway
- 276 Factory
- 278 Factory Fabric
- 280 Accessories

TOPAZ 24 MB DRAUGHTING

5^{YR} COMPONENT GUARANTEE	2^{YR} UPHOLSTERY GUARANTEE	150^{KG} WEIGHT TOLERANCE	24^H HOURS USAGE	MADE TO ORDER 20 DAYS
---	--	--	---	---



- PCB mechanism
- Medium back
- Fully contoured seat pad and back rest
- Priced in Camira Advantage

// NOTE: See page 267 for options

	Seat Dimensions	Back Dimensions	RRP
TPD21B // DRAUGHTING CHAIR	D440 W490 H590-830	W410 H410-480	£315.00

FR: Low
Fabric: 100% Man-made
Mechanism: PCB



TOPAZ 24 HB TASK

5^{YR} COMPONENT GUARANTEE	2^{YR} UPHOLSTERY GUARANTEE	150^{KG} WEIGHT TOLERANCE	24^H HOURS USAGE	MADE TO ORDER 20 DAYS
---	--	--	---	---



- PCB mechanism
- High back
- Fully contoured seat pad and back rest
- Priced in Camira Advantage

// NOTE: See page 267 for options

	Seat Dimensions	Back Dimensions	RRP
TP5B // NO ARMS	D450 W490 H420-530	W410 H490-560	£244.00
TP6B // WITH FIXED ARMS	D450 W490 H420-530	W410 H490-560	£284.00
TP7B // WITH ADJUSTABLE ARMS	D450 W490 H420-530	W410 H490-560	£308.00

FR: Low
Fabric: 100% Man-made
Mechanism: PCB



// NOTE: Model Shown is TP5B

TOPAZ 24 FULL BACK TASK

5^{YR} COMPONENT GUARANTEE	2^{YR} UPHOLSTERY GUARANTEE	150^{KG} WEIGHT TOLERANCE	24^H HOURS USAGE	MADE TO ORDER 20 DAYS
---	--	--	---	---



- PCB mechanism
- Full back
- Fully contoured seat pad and back rest
- Priced in Camira Advantage

// NOTE: See page 267 for options

	Seat Dimensions	Back Dimensions	RRP
TP11B // NO ARMS	D480 W490 H420-530	W480 H620-690	£281.00
TP12B // WITH FIXED ARMS	D480 W490 H420-530	W480 H620-690	£322.00
TP13B // WITH ADJUSTABLE ARMS	D480 W490 H420-530	W480 H620-690	£346.00

FR: Low
Fabric: 100% Man-made
Mechanism: PCB



// NOTE: Model Shown is TP13B

TOPAZ 24 MB TASK

5^{YR} COMPONENT GUARANTEE	2^{YR} UPHOLSTERY GUARANTEE	150^{KG} WEIGHT TOLERANCE	24^H HOURS USAGE	MADE TO ORDER 20 DAYS
---	--	--	---	---



- PCB mechanism
- Medium back
- Fully contoured seat pad and back rest
- Priced in Camira Advantage

// NOTE: See page 267 for options

	Seat Dimensions	Back Dimensions	RRP
TP21B // NO ARMS	D450 W490 H420-530	W410 H410-480	£235.00
TP22B // WITH FIXED ARMS	D450 W490 H420-530	W410 H410-480	£276.00
TP23B // WITH ADJUSTABLE ARMS	D450 W490 H420-530	W410 H410-480	£300.00

FR: Low
Fabric: 100% Man-made
Mechanism: PCB



// NOTE: Model Shown is TP22B

TOPAZ LITE MB TASK



- PCB mechanism
- Height adjustable back
- Topaz Lite stands for flexibility, quality & comfort
- Priced in Camira Advantage

// NOTE: See next page for options

	Seat Dimensions	Back Dimensions	RRP
TPL01B // NO ARMS	D430 W420 H420-530	W420 H450-500	£146.00
TPL02B // WITH FIXED ARMS	D430 W420 H420-530	W420 H450-500	£181.00
TPL03B // WITH ADJUSTABLE ARMS	D430 W420 H420-530	W420 H450-500	£214.00

FR: Low
Fabric: 100% Man-made
Mechanism: PCB

FABRIC FINISH



// NOTE: Model Shown is TPL01B

5 YR COMPONENT GUARANTEE	2 YR UPHOLSTERY GUARANTEE	150 KG WEIGHT TOLERANCE	8 H HOURS USAGE	MADE TO ORDER 20 DAYS
---------------------------------------	--	--------------------------------------	------------------------------	--------------------------------

TOPAZ LITE HB TASK



- PCB mechanism
- Height adjustable back
- Topaz Lite stands for flexibility, quality & comfort
- Priced in Camira Advantage

// NOTE: See next page for options

	Seat Dimensions	Back Dimensions	RRP
TPL24B // NO ARMS	D430 W420 H420-530	W420 H450-500	£158.00
TPL25B // WITH FIXED ARMS	D430 W420 H420-530	W420 H450-500	£194.00
TPL26B // WITH ADJUSTABLE ARMS	D430 W420 H420-530	W420 H450-500	£226.00

FR: Low
Fabric: 100% Man-made
Mechanism: PCB

FABRIC FINISH



// NOTE: Model Shown is TP13B

Options	RRP
TOPAZSS // SEAT SLIDE	£36.00
TOPAZC // POLISHED BASE	£42.00
TOPAZFA // FOLD AWAY HEIGHT ADJUSTABLE ARMS	£72.00
TOPAZSY // SYNCHRO MECHANISM	£60.00
TOPAZIL // INFLATABLE LUMBAR	£36.00



CONCEPT MB



- Deep cushioned seat and back upholstered in a tough wearing fabric
 - Permanent contact back (PCB) ensures user comfort for up to 8 hours
 - Backrest angle can be fixed or set to free float with the user
- // NOTE: see page 280 for arm options

	Seat Dimensions	Back Dimensions	RRP
CH0803 // CONCEPT MB	D470 W490 H460 - 585	W420 H410	£183.00

Unlimited Fabric Available
Please call for pricing

FR: Med
Fabric: 100% Man-made
Mechanism: PCB

FABRIC FINISH



5 YR COMPONENT GUARANTEE	2 YR UPHOLSTERY GUARANTEE	115 KG WEIGHT TOLERANCE	8 H HOURS USAGE
--------------------------------	---------------------------------	-------------------------------	-----------------------

CONCEPT DELUXE



- Deep cushioned seat and back upholstered in a tough wearing fabric
 - Asynchro mechanism allows each user to adapt the chair to their needs
- // NOTE: see page 280 for arm options

	Seat Dimensions	Back Dimensions	RRP
CH0801 // CONCEPT DELUXE	D460 W490 H460 - 585	W445 H510	£198.00

Unlimited Fabric Available
Please call for pricing

FR: Med
Fabric: 100% Man-made
Mechanism: Asynchro

FABRIC FINISH



5 YR COMPONENT GUARANTEE	2 YR UPHOLSTERY GUARANTEE	115 KG WEIGHT TOLERANCE	8 H HOURS USAGE
--------------------------------	---------------------------------	-------------------------------	-----------------------

CONCEPT HB



- Deep cushioned seat and back upholstered in a tough wearing fabric
 - Permanent contact back (PCB) ensures user comfort for up to 8 hours
 - Backrest angle can be fixed or set to free float with the user
- // NOTE: see page 280 for arm options

	Seat Dimensions	Back Dimensions	RRP
CH0802 // CONCEPT HB	D460 W490 H460 - 585	W445 H510	£188.00

Unlimited Fabric Available
Please call for pricing

FR: Med
Fabric: 100% Man-made
Mechanism: PCB

FABRIC FINISH



5 YR COMPONENT GUARANTEE	2 YR UPHOLSTERY GUARANTEE	115 KG WEIGHT TOLERANCE	8 H HOURS USAGE
--------------------------------	---------------------------------	-------------------------------	-----------------------

CONCEPT MAXI



- Largest of the Concept chairs
 - Deep cushioned seat and back upholstered in a tough wearing fabric
 - Asynchro mechanism with torsion control allows each user to adapt the chair to their needs
- // NOTE: see page 280 for arm options

	Seat Dimensions	Back Dimensions	RRP
CH0805 // CONCEPT MAXI	D500 W520 H500 - 630	W500 H600	£254.00

Unlimited Fabric Available
Please call for pricing

FR: Med
Fabric: 100% Man-made
Mechanism: Asynchro / torsion / ratchet back

FABRIC FINISH



5 YR COMPONENT GUARANTEE	2 YR UPHOLSTERY GUARANTEE	115 KG WEIGHT TOLERANCE	8 H HOURS USAGE
--------------------------------	---------------------------------	-------------------------------	-----------------------

CALYPSO SINGLE LEVER



2^{YR} COMPONENT GUARANTEE
 2^{YR} UPHOLSTERY GUARANTEE
 115^{KG} WEIGHT TOLERANCE
 8^H HOURS USAGE

- Deep cushioned seat and back upholstered in a tough wearing fabric
- Fixed back with solid steel support bar for maximum strength

// NOTE: see page 280 for arm options

	Seat Dimensions	Back Dimensions	RRP
CH2804PU // CALYPSO SINGLE LEVER	D440 W460 H485 - 615	W450 H490	£141.00
CH2804 // CALYPSO SINGLE LEVER	D440 W460 H485 - 615	W450 H490	£122.00

Unlimited Fabric Available
 Please call for pricing

FR: Med
 Fabric: 100% Man-made
 Mechanism: Fixed



CALYPSO HB



2^{YR} COMPONENT GUARANTEE
 2^{YR} UPHOLSTERY GUARANTEE
 115^{KG} WEIGHT TOLERANCE
 8^H HOURS USAGE

- Deep cushioned seat and back upholstered in a tough wearing fabric
- Permanent contact back (PCB) ensures user comfort for up to 8 hours
- Backrest angle can be fixed or set to free float with the user

// NOTE: see page 280 for arm options

	Seat Dimensions	Back Dimensions	RRP
CH2800PU // CALYPSO HB	D470 W470 H470 - 600	W450 H500	£146.00
CH2800 // CALYPSO HB	D470 W470 H470 - 600	W450 H500	£134.00

Unlimited Fabric Available
 Please call for pricing

FR: Med
 Fabric: 100% Man-made
 Mechanism: PCB



CALYPSO HB DELUXE



2^{YR} COMPONENT GUARANTEE
 2^{YR} UPHOLSTERY GUARANTEE
 115^{KG} WEIGHT TOLERANCE
 8^H HOURS USAGE

- Asynchro mechanism allows independent adjustment of height, back and seat angle
- Backrest angle can be fixed or set to free float with the user

// NOTE: see page 280 for arm options

	Seat Dimensions	Back Dimensions	RRP
CH2801PU // CALYPSO HB DELUXE	D470 W470 H470 - 600	W450 H500	£162.00
CH2801 // CALYPSO HB DELUXE	D470 W470 H470 - 600	W450 H500	£155.00

Unlimited Fabric Available
 Please call for pricing

FR: Med
 Fabric: 100% Man-made
 Mechanism: Asynchro



CALYPSO MESH



2^{YR} COMPONENT GUARANTEE
 2^{YR} UPHOLSTERY GUARANTEE
 115^{KG} WEIGHT TOLERANCE
 8^H HOURS USAGE

- Permanent contact back (PCB) ensures user comfort for up to 8 hours

// NOTE: see page 280 for arm options

	Seat Dimensions	Back Dimensions	RRP
CH2803 // CALYPSO MESH	D460 W480 H475 - 590	W420 H540	£222.00

Unlimited Fabric Available
 Please call for pricing

FR: Low
 Fabric: Mesh / 100% Man-made
 Mechanism: PCB



TYPIST CHAIR

2 ^{YR} COMPONENT GUARANTEE	2 ^{YR} UPHOLSTERY GUARANTEE	100 ^{KG} WEIGHT TOLERANCE	5 ^H HOURS USAGE
---	--	--	----------------------------------



- An entry level typist chair, meeting the needs of economical office applications
- Small and light, allowing easy movement

	Seat Dimensions	Back Dimensions	RRP
CH0712 // TYPIST CHAIR	D445 W460 H480 - 570	W390 H340	£96.00

FR: Med
Fabric: 100% Man-made
Mechanism: Fixed

FABRIC FINISH



ZOOM MB

2 ^{YR} COMPONENT GUARANTEE	2 ^{YR} UPHOLSTERY GUARANTEE	100 ^{KG} WEIGHT TOLERANCE	5 ^H HOURS USAGE
---	--	--	----------------------------------



- Deep cushioned seat and back upholstered in a tough wearing fabric
- Zoom Anti Tamper option features solid steel support bar for maximum strength
- Height adjustable seat

// NOTE: see page 280 for arm options

	Seat Dimensions	Back Dimensions	RRP
CH0709 // ZOOM MB	D450 W460 H485 - 615	W430 H415	£122.00
CH0702 // ZOOM ANTI TAMPER MB	D450 W460 H485 - 615	W430 H415	£142.00

FR: Med
Fabric: 100% Man-made
Mechanism: Fixed

FABRIC FINISH



ZOOM HB

2 ^{YR} COMPONENT GUARANTEE	2 ^{YR} UPHOLSTERY GUARANTEE	100 ^{KG} WEIGHT TOLERANCE	5 ^H HOURS USAGE
---	--	--	----------------------------------



- Deep cushioned seat and back upholstered in a tough wearing fabric
- Fixed back mechanism
- Height adjustable seat

// NOTE: see page 280 for arm options

	Seat Dimensions	Back Dimensions	RRP
CH0707 // ZOOM HB	D450 W460 H485 - 615	W430 H500	£122.00

FR: Med
Fabric: 100% Man-made
Mechanism: Fixed

FABRIC FINISHES



ZOOM VISITOR

2 ^{YR} COMPONENT GUARANTEE	2 ^{YR} UPHOLSTERY GUARANTEE	100 ^{KG} WEIGHT TOLERANCE	5 ^H HOURS USAGE
---	--	--	----------------------------------



- Sturdy powder coated black metal base
- Fixed back with solid steel support bar for maximum strength
- Plastic skid feet on base to avoid floor marking

// NOTE: see page 280 for arm options

	Seat Dimensions	Back Dimensions	RRP
CH0710 // ZOOM VISITOR	D445 W460 H480	W430 H410	£175.00

FR: Med
Fabric: 100% Man-made

FABRIC FINISH



LAPIS PERCH



5^{YR}
COMPONENT
GUARANTEE

115^{KG}
WEIGHT
TOLERANCE

8^H
HOURS
USAGE

- Seat angle adjustment from sitting to perch
- D-kit footrest as standard
- Ideal for use with sit stand desking

	Seat Dimensions	Back Dimensions	RRP
CH0510 // LAPIS	D340 W475 H580 - 780	W410 H450	£415.00

FR: Low
Fabric: Polyurethane
Mechanism: Fixed back

FABRIC FINISH



SWAY



2^{YR}
COMPONENT
GUARANTEE

2^{YR}
UPHOLSTERY
GUARANTEE

115^{KG}
WEIGHT
TOLERANCE

5^H
HOURS
USAGE

- Ideal for use with sit stand desking
- Height adjustable and can be used as a perch chair when at standing height
- Assists with core strengthening and stability

	Seat Dimensions	RRP
CH1257 // SWAY	D330 W330 H640 - 820	£151.00

FR: Med
Fabric: 100% Man-made
Mechanism: Fixed

FABRIC FINISH



FACTORY

5^{YR}
COMPONENT
GUARANTEE

115^{KG}
WEIGHT
TOLERANCE

8^H
HOURS
USAGE



- Versatile chair designed for assembly lines, science labs, factories and workshops
- Hard wearing, wipe clean, polyurethane seat and back
- Height adjustable seat

	Seat Dimensions	Back Dimensions	RRP
CH0504 // FACTORY	D440 W470 H465 - 590	W410 H310	£161.00

FR: Low
Fabric: Polyurethane
Mechanism: Fixed

FINISH

BK

FACTORY HIGH

5^{YR}
COMPONENT
GUARANTEE

115^{KG}
WEIGHT
TOLERANCE

8^H
HOURS
USAGE



- Versatile chair designed for assembly lines, science labs, factories and workshops
- Hard wearing, wipe clean, polyurethane seat and back
- Static or adjustable high rise draughtsman kit increases seat height to a maximum 845 mm

	Seat Dimensions	Back Dimensions	RRP
CH0504 + AC1014 // FACTORY HIGH STATIC	D440 W470 H715 - 830	W410 H310	£242.00
CH0504 + AC1042 // FACTORY HIGH ADJUSTABLE	D440 W470 H595 - 845	W410 H310	£262.00

FR: Low
Fabric: Polyurethane
Mechanism: Fixed
D-kit: Static / adjustable

FINISH

BK

// NOTE: Model Shown has static D-kit

FACTORY II

5^{YR}
COMPONENT
GUARANTEE

115^{KG}
WEIGHT
TOLERANCE

8^H
HOURS
USAGE



- Versatile chair designed for assembly lines, science labs, factories and workshops
- Hard wearing, wipe clean, polyurethane seat and back
- Height adjustable seat and backrest with PCB mechanism

	Seat Dimensions	Back Dimensions	RRP
CH0505 // FACTORY II	D430 W465 H445 - 575	W420 H310	£222.00

FR: Low
Fabric: Polyurethane
Mechanism: PCB

FINISH

BK

FACTORY II HIGH

5^{YR}
COMPONENT
GUARANTEE

115^{KG}
WEIGHT
TOLERANCE

8^H
HOURS
USAGE



- Versatile chair designed for assembly lines, science labs, factories and workshops
- Hard wearing, wipe clean, polyurethane seat and back with PCB mechanism
- Static or adjustable high rise draughtsman kit increases seat height to a maximum 835 mm

	Seat Dimensions	Back Dimensions	RRP
CH0505 + AC1014 // FACTORY II HIGH STATIC	D430 W465 H705 - 835	W420 H310	£302.00
CH0505 + AC1042 // FACTORY II HIGH ADJUSTABLE	D430 W465 H565 - 820	W420 H310	£322.00

FR: Low
Fabric: Polyurethane
Mechanism: PCB
D-kit: Static / adjustable

FINISH

BK

// NOTE: Model Shown has adjustable D-kit

ZOOM MB FIXED D-KIT

2^{YR} COMPONENT GUARANTEE 2^{YR} UPHOLSTERY GUARANTEE 110^{KG} WEIGHT TOLERANCE 5^H HOURS USAGE



- Static high rise draughtsman kit increases seat height to a maximum 870 mm
- Fixed foot-ring
- Supplied with glides

	Seat Dimensions	Back Dimensions	RRP
CH0709 + AC1014 // ZOOM MB FIXED D-KIT	D445 W460 H730 - 870	W435 H410	£205.00

FR: Med
Fabric: 100% Man-made
Mechanism: Fixed

FABRIC FINISH



ZOOM MB ADJUSTABLE D-KIT

2^{YR} COMPONENT GUARANTEE 2^{YR} UPHOLSTERY GUARANTEE 110^{KG} WEIGHT TOLERANCE 5^H HOURS USAGE



- Adjustable high rise draughtsman kit increases seat height to a maximum 865 mm
- Adjustable foot-ring
- Supplied with glides

	Seat Dimensions	Back Dimensions	RRP
CH0709 + AC1042 // ZOOM MB ADJUSTABLE D-KIT	D445 W460 H610 - 865	W435 H410	£248.00

FR: Med
Fabric: 100% Man-made
Mechanism: Fixed

FABRIC FINISH



CONCEPT MB FIXED D-KIT

5^{YR} COMPONENT GUARANTEE 2^{YR} UPHOLSTERY GUARANTEE 115^{KG} WEIGHT TOLERANCE 8^H HOURS USAGE



- Static high rise draughtsman kit increases seat height to a maximum 835 mm
- Fixed foot-ring
- Supplied with glides

	Seat Dimensions	Back Dimensions	RRP
CH0803 + AC1014 // CONCEPT MB FIXED D-KIT	D475 W470 H705 - 835	W420 H400	£270.00

Unlimited Fabric Available

Please call for pricing

FR: Med
Fabric: 100% Man-made
Mechanism: PCB

FABRIC FINISHES



CONCEPT MB ADJUSTABLE D-KIT

5^{YR} COMPONENT GUARANTEE 2^{YR} UPHOLSTERY GUARANTEE 115^{KG} WEIGHT TOLERANCE 8^H HOURS USAGE



- Adjustable high rise draughtsman kit increases seat height to a maximum 830 mm
- Adjustable foot-ring
- Supplied with glides

	Seat Dimensions	Back Dimensions	RRP
CH0803 + AC1042 // CONCEPT MB ADJUSTABLE D-KIT	D475 W470 H585 - 830	W420 H400	£314.00

Unlimited Fabric Available

Please call for pricing

FR: Med
Fabric: 100% Man-made
Mechanism: PCB

FABRIC FINISHES



OPERATOR CHAIR ARMS

ZOOM ARMS



2YR
COMPONENT
GUARANTEE

Description	RRP
AC1041 FIXED ARMS	£31.00

BK



2YR
COMPONENT
GUARANTEE

Description	RRP
AC1046 1D ADJUSTABLE ARMS	£52.00

BK

CALYPSO II & CONCEPT ARMS



5YR
COMPONENT
GUARANTEE

Description	RRP
AC1034 CHROME ADJUSTABLE ARMS	£80.00

BK



5YR
COMPONENT
GUARANTEE

Description	RRP
AC1002 FIXED ARMS	£35.00

BK



5YR
COMPONENT
GUARANTEE

Description	RRP
AC1040 1D ADJUSTABLE ARMS	£58.00

BK



5YR
COMPONENT
GUARANTEE

Description	RRP
AC1082 FOLDING ARMS	£73.00

BK

ACCESSORIES

5 STAR BASES



Description	RRP
AC1024 CHROME BASE	£73.00



Description	RRP
AC1068 POLISHED ALUMINIUM BASE	£90.00

TECHNICAL



Description	RRP
AC1042 HI-RISE ADJUSTABLE KIT	£101.00



Description	RRP
AC1014 STATIC KIT	£81.00

// FACTORY CHAIRS

Your comfort and safety is our primary concern. We advise never to use the Factory range D-kits on any chair with a tilting seat, or to use anything other than the glides provided. Castors are not recommended with any draughtsman kit.

CASTORS / GLIDES



Description	RRP
AC1030 11mm ONION GLIDES	£25.00



Description	RRP
AC1031 11mm FLAT GLIDES	£25.00



Description	RRP
AC1050 ANTI-STATIC CASTORS	£44.00



Description	RRP
AC1047 BRAKE LOADED CASTORS	£58.00



Description	RRP
AC1048 BRAKE UNLOADED CASTORS	£40.00



Description	RRP
AC1058 CHROME CASTORS	£52.00



Description	RRP
AC1051 SOFT TYRE CASTORS	£41.00

CAFE & DINING

// 17

A stylish and alternative café and dining area can completely transform a working environment; we've carefully selected these contemporary products with this in mind.

CONTENTS

284	Adapt	297	Ramiro	310	Folding Chair
286	Ariel	297	Milano	310	Folding Chair Trolley
288	Chester	298	Picasso		
290	Fjord	300	Picasso Lite		
291	Benny	300	Ellipse		
292	Bjorn	302	Picnic		
294	Lunar	304	Stork		
295	Sena	304	Astral High		
296	Orlando	306	Plaza		
296	Forza	308	Morph		

ADAPT SIDE CHAIR

5^{YR}
COMPONENT
GUARANTEE

115^{KG}
WEIGHT
TOLERANCE

8^H
HOURS
USAGE



- A colourful, modern chair with a chrome 4 leg base
- Easy clean, durable plastic seat
- Stacks 4 high

	Seat Dimensions	Back Dimensions	RRP
CH2101 // ADAPT SIDE CHAIR	D400 W415 H470	W385 H370	£134.00

FR: Low
Material: Polypropylene
Storage: Stacks 4

FINISHES



ADAPT HIGH CHAIR

5^{YR}
COMPONENT
GUARANTEE

115^{KG}
WEIGHT
TOLERANCE

8^H
HOURS
USAGE



- A colourful, modern high chair with chrome legs
- Easy clean, durable plastic seat
- Stacks 3 high

	Seat Dimensions	Back Dimensions	RRP
CH2103 // ADAPT HIGH CHAIR	D400 W415 H775	W385 H370	£188.00

FR: Low
Material: Polypropylene
Storage: Stacks 3

FINISHES



ADAPT SKID

5^{YR}
COMPONENT
GUARANTEE

115^{KG}
WEIGHT
TOLERANCE

8^H
HOURS
USAGE



- A colourful, modern chair with a skid base
- Easy clean, durable plastic seat
- Stacks 4 high

	Seat Dimensions	Back Dimensions	RRP
CH2102 // ADAPT SKID	D400 W415 H470	W385 H370	£134.00

FR: Low
Material: Polypropylene
Storage: Stacks 4

FINISHES



ARIEL II CHROME LEG

5^{YR}
COMPONENT
GUARANTEE

115^{KG}
WEIGHT
TOLERANCE

8^H
HOURS
USAGE



- Easy clean seat and chrome 4 leg base
- Revised seat shell to aid posture and comfort
- Stacks 4 high

	Seat Dimensions	Back Dimensions	RRP
CH2507 // CHROME 4-LEG	D370 W380 H440	W430 H470	£150.00

FR: Low
Material: Polypropylene
Storage: Stacks 4

FINISHES



ARIEL II SPIDER BASE

5^{YR}
COMPONENT
GUARANTEE

115^{KG}
WEIGHT
TOLERANCE

8^H
HOURS
USAGE



- Easy clean seat and white spider base with castors
- Revised seat shell to aid posture and comfort

	Seat Dimensions	Back Dimensions	RRP
CH2509 // SPIDER BASE	D370 W380 H430 - 490	W430 H470	£160.00

FR: Low
Material: Polypropylene
Mechanism: Fixed

FINISHES



ARIEL II WOODEN LEG

5^{YR}
COMPONENT
GUARANTEE

115^{KG}
WEIGHT
TOLERANCE

8^H
HOURS
USAGE



- Easy clean seat and round wooden 4 leg base
- Revised seat shell to aid posture and comfort

	Seat Dimensions	Back Dimensions	RRP
CH2508 // WOODEN LEG	D370 W380 H440	W430 H470	£160.00

FR: Low
Material: Polypropylene

FINISHES



// NOTE: Shade matching of wooden leg cannot be guaranteed

ARIEL II WIRE BASE

5^{YR}
COMPONENT
GUARANTEE

115^{KG}
WEIGHT
TOLERANCE

8^H
HOURS
USAGE



- Easy clean seat and round wooden 4 leg base with black wire detailing
- Revised seat shell to aid posture and comfort

	Seat Dimensions	Back Dimensions	RRP
CH2510 // WIRE BASE	D370 W380 H440	W430 H470	£160.00

FR: Low
Material: Polypropylene

FINISHES



// NOTE: Shade matching of wooden leg cannot be guaranteed

CHESTER WOODEN LEG

5^{YR}
COMPONENT
GUARANTEE

115^{KG}
WEIGHT
TOLERANCE

8^H
HOURS
USAGE



- Easy clean seat
- Round wooden 4 leg base

	Seat Dimensions	Back Dimensions	RRP
CH2511 // WOODEN LEG	D410 W470 H420	W430 H380	£95.00

FR: Low
Material: Polypropylene

FINISHES



CHESTER WIRE BASE

5^{YR}
COMPONENT
GUARANTEE

115^{KG}
WEIGHT
TOLERANCE

8^H
HOURS
USAGE



- Easy clean seat
- 4 leg wire base

	Seat Dimensions	Back Dimensions	RRP
CH2512 // WIRE BASE	D410 W470 H420	W430 H380	£105.00

FR: Low
Material: Polypropylene

FINISHES



CHESTER SPIDER BASE

5^{YR}
COMPONENT
GUARANTEE

115^{KG}
WEIGHT
TOLERANCE

8^H
HOURS
USAGE



- Easy clean seat
- Chrome spider base with castors

	Seat Dimensions	Back Dimensions	RRP
CH2513 // SPIDER BASE	D410 W470 H460 - 520	W430 H380	£105.00

FR: Low
Material: Polypropylene
Mechanism: Fixed

FINISHES



FJORD 4-LEG

5 YR COMPONENT GUARANTEE	115 KG WEIGHT TOLERANCE	8 H HOURS USAGE	MADE TO ORDER 25 DAYS
---------------------------------------	--------------------------------------	------------------------------	--------------------------------



- One piece polypropylene shell
- Upholstered seat pad option, priced in Camira Advantage
- Ideal for dining and meeting areas
- Black (BK) or silver (P) frame as standard with chrome (C) frame available at an extra cost. Call for details

	Seat Dimensions	Back Dimensions	RRP
FJO20 // 4-LEG	D520 W450 H450	W400 H390	£152.00 •
FJO30 // 4-LEG UPHOLSTERED	D520 W450 H450	W400 H380	£186.00 •

SHELL FINISH // METAL FRAME FINISH // SEAT PAD FINISH



FJORD WOODEN 4-LEG

5 YR COMPONENT GUARANTEE	115 KG WEIGHT TOLERANCE	8 H HOURS USAGE	MADE TO ORDER 25 DAYS
---------------------------------------	--------------------------------------	------------------------------	--------------------------------



- Wooden oak frame
- One piece polypropylene shell
- Upholstered seat pad option, priced in Camira Advantage
- Ideal for dining and meeting areas
- Frame available in walnut (WL), oak (OA) or black (BK) wood

	Seat Dimensions	Back Dimensions	RRP
FJO21 // WOODEN 4-LEG	D520 W450 H450	W400 H390	£272.00 •
FJO31 // WOODEN 4-LEG UPHOLSTERED	D520 W450 H450	W400 H380	£305.00 •

SHELL FINISH // WOODEN FRAME FINISH // SEAT PAD FINISH



• Refer to trade price list. E&EO. All items are subject to VAT, where applicable.

BENNY TABLE

5 YR COMPONENT GUARANTEE	MADE TO ORDER 25 DAYS
---------------------------------------	--------------------------------



- The top can be specified in walnut (WL), maple (MP) or white (WH)
- Available in a chrome round base or a polished aluminium 4 star base

	Dimension	RRP
BN2 // POLISHED ALUMINIUM 4 STAR BASE	D800 W800 H730	£354.00 •
BN12 // CHROME ROUND BASE	D800 W800 H730	£432.00 •

FINISHES



// NOTE: Model Bistro Meeting Table BN2/WH/C shown

BENNY HIGH TABLE

5 YR COMPONENT GUARANTEE	MADE TO ORDER 25 DAYS
---------------------------------------	--------------------------------



- The top can be specified in walnut (WL), maple (MP) or white (WH)
- Available in a chrome round base or a polished aluminium 4 star base

	Dimension	RRP
BN5 // POLISHED ALUMINIUM 4 STAR BASE	D600 W600 H1050	£377.00 •
BN15 // CHROME ROUND BASE	D600 W600 H1050	£407.00 •

FINISHES



// NOTE: Model Meeting Table BN15/WH/C shown

BJÖRN 4-LEG

5YR COMPONENT GUARANTEE
2YR UPHOLSTERY GUARANTEE
MADE TO ORDER 25 DAYS



- Brings a fresh look to your dining or breakout areas
- Chrome frame
- Extremely comfortable ribbed upholstered seat and back shell or one piece wooden shell

	Seat Dimensions	Back Dimensions	RRP
BJN21 // UPHOLSTERED SEAT 4-LEG CHAIR	D510 W460 H450	W380 H450	£155.00 •
BJN11 // WOODEN SEAT 4-LEG CHAIR	D510 W460 H450	W380 H430	£170.00 •

FABRIC FINISHES // WOODEN FINISHES



BJÖRN WOODEN 4-LEG

5YR COMPONENT GUARANTEE
2YR UPHOLSTERY GUARANTEE
MADE TO ORDER 25 DAYS



- Brings a fresh look to your dining or breakout areas
- Wooden beech frame and legs
- Extremely comfortable ribbed upholstered seat and back shell or one piece wooden shell

	Seat Dimensions	Back Dimensions	RRP
BJN23 // UPHOLSTERED SEAT 4-LEG CHAIR	D510 W460 H450	W380 H450	£263.00 •
BJN13 // WOODEN SEAT 4-LEG CHAIR	D510 W460 H450	W380 H430	£278.00 •

FABRIC FINISHES // WOODEN FINISHES

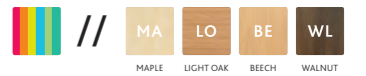

BJÖRN SLED

5YR COMPONENT GUARANTEE
2YR UPHOLSTERY GUARANTEE
MADE TO ORDER 25 DAYS



- Brings a fresh look to your dining or breakout areas
- Chrome frame
- Extremely comfortable ribbed upholstered seat and back shell or one piece wooden shell

	Seat Dimensions	Back Dimensions	RRP
BJN22 // UPHOLSTERED SEAT SLED BASE CHAIR	D510 W460 H450	W380 H450	£155.00 •
BJN12 // WOODEN SEAT SLED BASE CHAIR	D510 W460 H450	W380 H430	£170.00 •

FABRIC FINISHES // WOODEN FINISHES



BJÖRN STOOL

5YR COMPONENT GUARANTEE
2YR UPHOLSTERY GUARANTEE
MADE TO ORDER 25 DAYS



- Brings a fresh look to your dining or breakout areas
- Wooden beech frame and legs or chrome frame
- Extremely comfortable ribbed upholstered seat & back shell

	Seat Dimensions	Back Dimensions	RRP
BJN52 // 4-LEG CHROME STOOL	D490 W490 H770	W360 H130	£211.00 •
BJN64 // 4-LEG WOODEN STOOL	D490 W490 H770	W360 H150	£361.00 •

FABRIC FINISHES // WOODEN FINISHES



• Refer to trade price list. E&EO. All items are subject to VAT, where applicable.

LUNAR DINING CHAIR

3 YR
COMPONENT
GUARANTEE

MADE
TO
ORDER
10 DAYS



- Chic retro look and soft lines combine with comfort
- Chair frame colours available in oak, raw or walnut
- Strong and durable
- Veneer seat

	Seat Dimensions	Overall Dimensions	RRP
HUDOAKVEN // OAK DINING CHAIR	D500 W450 H440	W450 H810	£270.00
HUDRAWVEN // RAW DINING CHAIR	D500 W450 H440	W450 H810	£270.00
HUDWALVEN // WALNUT DINING CHAIR	D500 W450 H440	W450 H810	£270.00

FINISHES



LUNAR UPHOLSTERED DINING CHAIR

3 YR
COMPONENT
GUARANTEE

2 YR
UPHOLSTERY
GUARANTEE

MADE
TO
ORDER
10 DAYS



- Chic retro look and soft lines combine with comfort
- Chair frame colours available in oak, raw or walnut
- Strong and durable
- Seren faux leather cream seat

	Seat Dimensions	Overall Dimensions	RRP
HUDOAKFBS // OAK DINING CHAIR	D500 W450 H440	W450 H810	£302.00
HUDRAWRFU // RAW DINING CHAIR	D500 W450 H440	W450 H810	£302.00
HUDWALFBS // WALNUT DINING CHAIR	D500 W450 H440	W450 H810	£302.00

FINISHES



SENA SIDE CHAIR

3 YR
COMPONENT
GUARANTEE

2 YR
UPHOLSTERY
GUARANTEE

MADE
TO
ORDER
10 DAYS



- Sena dining chair with Wenge wood frame
- At home in both traditional and contemporary environments alike
- Comfortable and practical faux leather seat and back available in dark chestnut, pewter or cream
- Strong and durable

	Seat Dimensions	Overall Dimensions	RRP
SEN // DINING SIDE CHAIR	D430 W430 H490	W430 H835	£198.00

FINISHES



SENA ARMCHAIR

3 YR
COMPONENT
GUARANTEE

2 YR
UPHOLSTERY
GUARANTEE

MADE
TO
ORDER
10 DAYS



- Sena armchair with Wenge wood frame
- At home in both traditional and contemporary environments alike
- Comfortable and practical faux leather seat and back available in dark chestnut, pewter or cream
- Strong and durable

	Seat Dimensions	Overall Dimensions	RRP
SENAC // DINING ARM CHAIR	D430 W430 H490	W545 H835	£271.00

FINISHES



ORLANDO

3YR COMPONENT GUARANTEE
25MM TOP THICKNESS
MADE TO ORDER
10 DAYS



- Made from top grade cast iron
- Adjustable feet
- Column in either a high quality chrome plating or a powder coated finish

	Dimensions	RRP
ZORLDRB7 // DINING - ROUND TOP, BLACK COLUMN	D700 W700 H755	£210.00
ZORLDRC7 // DINING - ROUND TOP, CHROME COLUMN	D700 W700 H755	£222.00
ZORLDSB77 // DINING - SQUARE TOP, BLACK COLUMN	D700 W700 H755	£177.00
ZORLDS77 // DINING - SQUARE TOP, CHROME COLUMN	D700 W700 H755	£188.00
ZORLPRB7 // POSEUR - ROUND TOP, BLACK COLUMN	D700 W700 H1075	£213.00
ZORLPRC7 // POSEUR - ROUND TOP, CHROME COLUMN	D700 W700 H1075	£229.00

TOP FINISHES // LEG FINISHES



// NOTE: MODEL SHOWN IS ZORLDSB77

FORZA

3YR COMPONENT GUARANTEE
25MM TOP THICKNESS
MADE TO ORDER
10 DAYS



- Affordable and simple base in a slimline design
- Made from high grade cast iron with a powder coated finish

	Dimensions	RRP
ZFORDRB7 // DINING - ROUND BASE & TOP, BLACK COLUMN	D700 W700 H755	£256.00
ZFORDSB77 // DINING - SQUARE BASE & TOP, BLACK COLUMN	D700 W700 H755	£222.00
ZFORPRB7 // POSEUR - ROUND BASE & TOP, BLACK COLUMN	D700 W700 H1075	£268.00

TOP FINISHES // LEG FINISH



// NOTE: Model Shown is ZFORDSB77

RAMIRO

3YR COMPONENT GUARANTEE
25MM TOP THICKNESS
MADE TO ORDER
10 DAYS



- Solid cast iron base
- Stylish trumpet table base finished in chrome plating
- Adjustable feet

	Dimensions	RRP
ZRAMDR7 // DINING - ROUND TOP & BASE, CHROME COLUMN	D700 W700 H755	£312.00

TOP FINISHES // LEG FINISHES



// NOTE: MODEL SHOWN IS ZRAMDR7

MILANO FLIP TOP

3YR COMPONENT GUARANTEE
25MM TOP THICKNESS
MADE TO ORDER
10 DAYS



- Simple lever unlocks and folds the upper section
- Can be nested together
- Adjustable feet
- Weather resistant anodised aluminium

	Dimensions	RRP
AFTD1 // DINING - SQUARE TOP	D700 W700 H730	£324.00
AFTP1 // POSEUR - ROUND TOP	D700 W700 H1050	£371.00

TOP FINISHES // LEG FINISHES



// NOTE: Model Shown is AFTD1

PICASSO CONTRACT

5^{YR}
COMPONENT
GUARANTEE

115^{KG}
WEIGHT
TOLERANCE

8^H
HOURS
USAGE



- Welded chrome frame
- Stackable up to 4 high
- Plastic capped feet
- Suitable for cafe and canteens

	Seat Dimensions	Back Dimensions	RRP
CH0672BE // BEECH	D390 W450 H470	W435 H400	£122.00

FR: Low
Material: Wood veneer
Storage: Stacks 4

FINISH
BE

PICASSO CONTRACT

5^{YR}
COMPONENT
GUARANTEE

115^{KG}
WEIGHT
TOLERANCE

8^H
HOURS
USAGE



- Welded chrome frame
- Stackable up to 4 high
- Plastic capped feet
- Suitable for cafe and canteens

	Seat Dimensions	Back Dimensions	RRP
CH0672WH // WHITE	D390 W450 H470	W435 H400	£122.00

FR: Low
Material: High gloss lacquer
Storage: Stacks 4

FINISH
WH

PICASSO CONTRACT

5^{YR}
COMPONENT
GUARANTEE

115^{KG}
WEIGHT
TOLERANCE

8^H
HOURS
USAGE



- Welded chrome frame
- Stackable up to 4 high
- Plastic capped feet
- Suitable for cafe and canteens

	Seat Dimensions	Back Dimensions	RRP
CH0672WA // WALNUT	D390 W450 H470	W435 H400	£122.00

FR: Low
Material: Wood veneer
Storage: Stacks 4

FINISH
WA



PICASSO LITE

2^{YR}
COMPONENT
GUARANTEE

100^{KG}
WEIGHT
TOLERANCE

5^H
HOURS
USAGE



- Distinctive stacking chair with a contemporary look
- Polished veneer seat and back
- Chrome frame with plastic feet

	Seat Dimensions	Back Dimensions	RRP
CH0514 // PICASSO LITE	D380 W440 H480	W435 H420	£90.00

FR: Low
Material: Wood veneer
Storage: Stacks 4

FINISHES



ELLIPSE 4-LEG

2^{YR}
COMPONENT
GUARANTEE

20^{MM}
TOP
THICKNESS



- Plastic capped feet for stability
- Durable and easy-clean top
- Chrome legs

	Dimensions	RRP
CH0675 // 4-LEG	D800 W800 H740	£276.00

Material: Wood veneer / white in high gloss lacquer

FINISHES



ELLIPSE TRUMPET

2^{YR}
COMPONENT
GUARANTEE

20^{MM}
TOP
THICKNESS



- Heavy flared base for stability
- Durable and easy-clean top
- Chrome trumpet base

	Dimensions	RRP
CH0676 // TRUMPET	D800 W800 H740	£286.00

Material: Wood veneer / white in high gloss lacquer

FINISHES



PICNIC

5 YR
COMPONENT
GUARANTEE

25^{MM}
TOP
THICKNESS

MADE
TO
ORDER
28 DAYS



- 25mm top thickness
- Heavy duty frame (KD)
- 2 height options available

BENCH

	Dimensions			RRP
	W	D	H	
PCB1435 (FITS 1600 LOW TABLE)	1400	350	410	£429.00
PCB1635 (FITS 1800 LOW TABLE)	1600	350	410	£450.00
PCB1835 (FITS 2000 LOW TABLE)	1800	350	410	£462.00

LOW TABLE

	Dimensions			RRP
	W	D	H	
PCTL1680	1600	800	740	£592.00
PCTL1880	1800	800	740	£603.00
PCTL2000	2000	800	740	£691.00

HIGH TABLE

	Dimensions			RRP
	W	D	H	
PCTH1680	1600	800	1100	£647.00
PCTH1880	1800	800	1100	£658.00
PCTH2000	2000	800	1100	£734.00

TOP FINISHES // FRAME FINISHES



STORK

5YR
COMPONENT
GUARANTEE

115KG
WEIGHT
TOLERANCE

5H
HOURS
USAGE



- Sculpted seat and back with wood veneer finish or high gloss lacquer
- Height adjustable seat
- Chrome trumpet base

	Seat Dimensions	Back Dimensions	RRP
CH0670 // HIGH CHAIR	D390 W405 H580 - 805	W405 H245	£243.00

FR: Low
Material: Wood veneer / white is high gloss lacquer
Mechanism: Fixed / gas height adjustable

FINISHES



ASTRAL HIGH TABLE

2YR
COMPONENT
GUARANTEE

20MM
TOP
THICKNESS



- Heavy flared base for stability
- Durable and easy-clean top
- Chrome trumpet base

	Dimensions	RRP
CH0677 // HIGH TABLE	D600 W600 H1045	£286.00

FR: Low
Material: Wood veneer / white in high gloss lacquer

FINISHES



PLAZA WICKER

2YR
COMPONENT
GUARANTEE

115KG
WEIGHT
TOLERANCE

5H
HOURS
USAGE



- Available in blue or natural finish
 - Stylish open construction for comfort on sunny days
 - Polished aluminium frame with wicker seat
 - Sturdy and durable, for indoor or outdoor use
- // NOTE:** Not suitable for outdoor storage

	Seat Dimensions	Back Dimensions	RRP
CH0660 // PLAZA WICKER	D410 W435 H430	W340 H390	£95.00

FR: Low
Material: Polypropylene / aluminium
Storage: Stacks 8
Arms: Fixed

FINISHES



PLAZA ARMCHAIR

2YR
COMPONENT
GUARANTEE

115KG
WEIGHT
TOLERANCE

8H
HOURS
USAGE



- Stylish open construction for comfort on sunny days
 - Polished aluminium frame
 - Sturdy and durable, for indoor or outdoor use
- // NOTE:** Not suitable for outdoor storage

	Seat Dimensions	Back Dimensions	RRP
CH0653 // ARMCHAIR	D400 W435 H440	W340 H390	£77.00

FR: Low
Material: Aluminium
Storage: Stacks 8
Arms: Fixed

PLAZA TABLE

2YR
COMPONENT
GUARANTEE



- Stylish round aluminium table to complement our range of chairs
 - Polished aluminium top and base
 - Sturdy and durable, for indoor or outdoor use
- // NOTE:** Not suitable for outdoor storage

	Dimensions	RRP
CH0651 // TABLE	D600 W600 H700	£122.00

FR: Low
Material: Aluminium



MORPH FOLDING CHAIR

2YR
COMPONENT
GUARANTEE

115KG
WEIGHT
TOLERANCE

5H
HOURS
USAGE



- Durable off-white folding chair with moulded handle and plastic feet
- Sturdy dark grey metal legs and frame
- Wipe-clean surfaces and hinged folding mechanism

	Seat Dimensions	Back Dimensions	RRP
OF0410WH // FOLDING CHAIR	D380 W480 H465	W430 H310	£63.00

FR: Low
Material: Polypropylene
Storage: Folding

FINISH

OW

MORPH CIRCULAR FOLDING TABLE

2YR
COMPONENT
GUARANTEE

25KG
WEIGHT
TOLERANCE



	Dimensions	RRP
OF0404WH // CIRCULAR FOLDING	D1200 W1200 H750	£144.00

- Circular folding table with an off-white plastic top
- Sturdy dark grey metal legs and frame
- Wipe-clean top with rounded edges

FR: Low
Material: Polypropylene
Storage: Folding

FINISH

OW

MORPH RECTANGULAR FOLDING TABLE

2YR
COMPONENT
GUARANTEE

25KG
WEIGHT
TOLERANCE



	Dimensions	RRP
OF0403WH // 1210 TABLE	D600 W1210 H750	£122.00
OF0402WH // 1510 TABLE	D760 W1510 H750	£144.00
OF0401WH // 1830 TABLE	D760 W1830 H750	£167.00

- Rectangular folding table with an off-white plastic top
- Sturdy dark grey metal legs and frame
- Wipe-clean top with rounded edges

FR: Low
Material: Polypropylene
Storage: Folding

FINISH

OW

FOLDING CHAIR

2YR
COMPONENT
GUARANTEE

100KG
WEIGHT
TOLERANCE

8H
HOURS
USAGE



- Available in blue or charcoal finish
- Folds flat for neat and easy storage
- Comfortable contoured seat and back

	Seat Dimensions	Back Dimensions
TCFAFCLK // FOLDING CHAIR	D395 W395 H440	W440 H460

FR: Low
Material: Polypropylene

FINISHES



FOLDING CHAIR TROLLEY

2YR
COMPONENT
GUARANTEE

80KG
WEIGHT
TOLERANCE



- Easy to control with two swivel and two fixed castors
- Simple assembly

	Dimensions
TC40T // 40 CAPACITY TROLLEY	D540 W1120 H1000
TC70T // 70 CAPACITY TROLLEY	D1750 W790 H1100
TC140T // 140 CAPACITY TROLLEY	D1750 W790 H2250

FINISH



Integral linking clip

SOFT SEATING

// 18

From armchairs in contemporary fabric finishes to acoustic booths, soft seating is the perfect way to create a collaborative and flexible working environment.

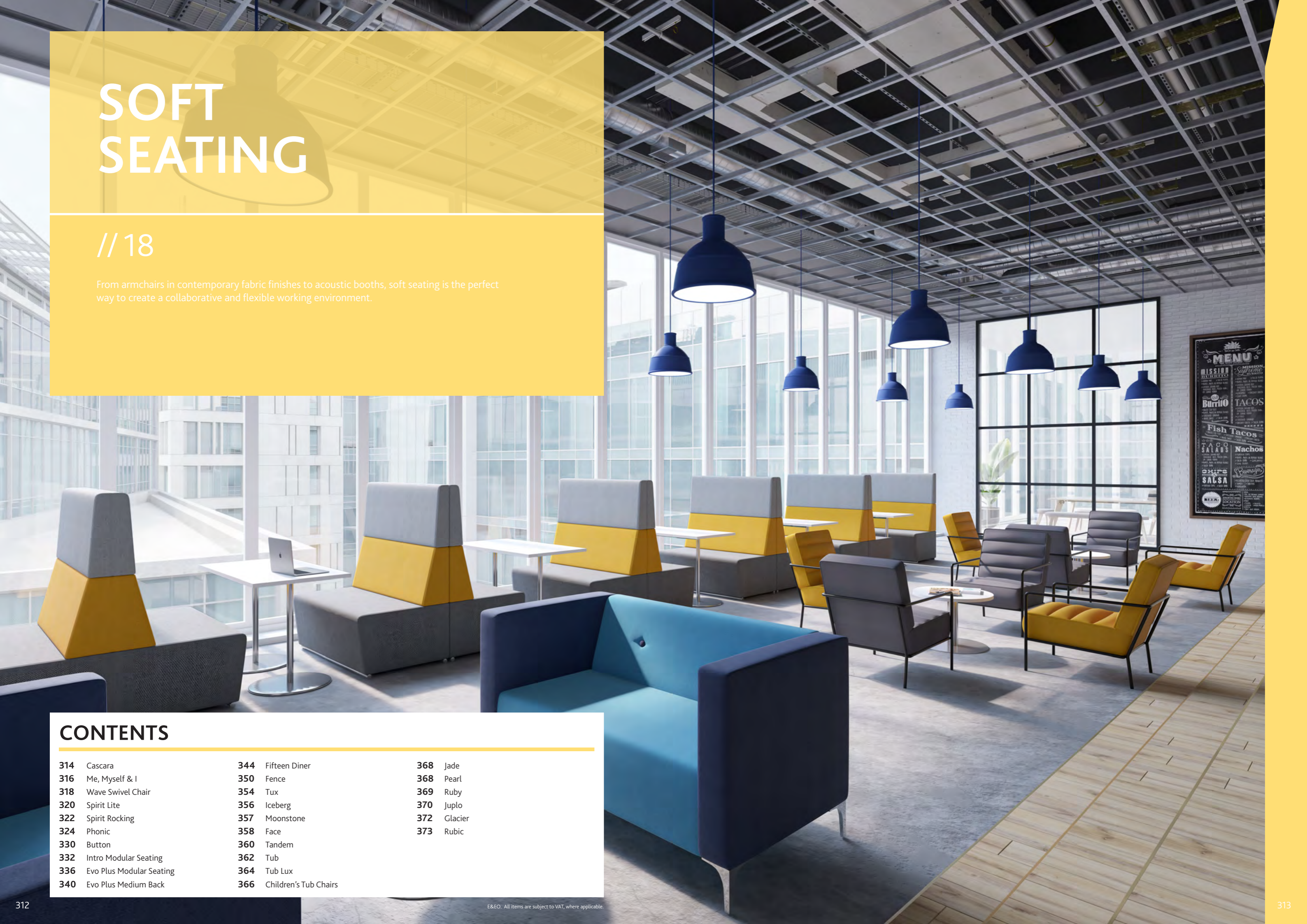

CONTENTS

314	Cascara	344	Fifteen Diner	368	Jade
316	Me, Myself & I	350	Fence	368	Pearl
318	Wave Swivel Chair	354	Tux	369	Ruby
320	Spirit Lite	356	Iceberg	370	Juplo
322	Spirit Rocking	357	Moonstone	372	Glacier
324	Phonic	358	Face	373	Rubic
330	Button	360	Tandem		
332	Intro Modular Seating	362	Tub		
336	Evo Plus Modular Seating	364	Tub Lux		
340	Evo Plus Medium Back	366	Children's Tub Chairs		

CASCARA HB WOOD

5 YR
COMPONENT
GUARANTEE

MADE
TO
ORDER
30 DAYS



- Beech leg as standard
- Other wooden leg options available, walnut stain, wenge stain and painted white legs. Please call for details

	Seat Dimensions	Back Dimensions	RRP	Unlimited Fabric Available
CASHBSWWA/L // SWIVEL CHAIR	D730 W730 H1055	W630 H630	£1314.00	Please call for pricing
CASHBWLWA/WA/L // 4-LEG	D600 W630 H1020	W630 H580	£1339.00	

FR: Subject to selected fabric
Fabric: Leather / 100% Man-made

LEATHER FINISH // FABRIC FINISH



FOOT STOOL

5 YR
COMPONENT
GUARANTEE

MADE
TO
ORDER
30 DAYS



- Beech leg as standard
- Other wooden leg options available, walnut stain, wenge stain and painted white legs. Please call for details

	Overall Dimensions	RRP	Unlimited Fabric Available
CASFSCWA/L // WOODEN CHROME BASE, LEATHER	D475 W630 H570	£727.00	Please call for pricing
CASFSLWA/L // WOODEN 4-LEG BEECH BASE, LEATHER	D580 W630 H540	£751.00	
CASFSCFU // FABRIC CHROME BASE	D475 W630 H570	£536.00	
CASFSLWA/WA // WOODEN 4-LEG BASE, FABRIC	D580 W630 H540	£593.00	

FR: Subject to selected fabric
Fabric: Leather / 100% Man-made

LEATHER FINISH // FABRIC FINISH



CASCARA HB FABRIC

5 YR
COMPONENT
GUARANTEE

MADE
TO
ORDER
30 DAYS



- Beech leg as standard
- Other wooden leg options available, walnut stain, wenge stain and painted white legs. Please call for details

	Seat Dimensions	Back Dimensions	RRP	Unlimited Fabric Available
CASHBSWFU // SWIVEL	D730 W730 H1055	W630 H630	£921.00	Please call for pricing
CASHBWLFW/WA // 4-LEG	D600 W630 H1020	W630 H580	£945.00	

FR: Subject to selected fabric
Fabric: Leather / 100% Man-made

LEATHER FINISH // FABRIC FINISH



ME, MYSELF & I

5 YR COMPONENT GUARANTEE
MADE TO ORDER
30 DAYS



- Leg finishes walnut stain, beech stain, light oak stain and maple stain
- Two tone upholstery available as an optional extra. Please call for details

LOW BACK UPHOLSTERED CHAIR

	Dimensions	RRP
MMI-01 // WOODEN 4-LEG BASE	D700 W780 H750	£379.00

FABRIC FINISH



FR: Subject to selected fabric
Fabric: 100% Man-made

NOTE: Shown in two tone upholstery which is an extra 10%, with light oak frame



- Leg finishes walnut stain, beech stain, light oak stain and maple stain
- Two tone upholstery available as an optional extra. Please call for details

MEDIUM BACK UPHOLSTERED CHAIR

	Dimensions	RRP
MMI-02 // WOODEN 4-LEG BASE	D700 W780 H850	£569.00

FABRIC FINISH



FR: Subject to selected fabric
Fabric: 100% Man-made

NOTE: Shown in two tone upholstery which is an extra 10%, with light oak frame



- Leg finishes walnut stain, beech stain, light oak stain and maple stain
- Two tone upholstery available as an optional extra. Please call for details

HIGH BACK UPHOLSTERED CHAIR

	Dimensions	RRP
MMI-03 // WOODEN 4-LEG BASE	D700 W780 H950	£592.00

FABRIC FINISH



FR: Subject to selected fabric
Fabric: 100% Man-made

NOTE: Shown in two tone upholstery which is an extra 10%, with light oak frame



- Tops available in white, light oak and walnut
- Leg finishes walnut stain, beech stain, light oak stain and maple stain

WOODEN TABLE

	Dimensions	RRP
MMIT-1 // SQUARE TABLE	D555 W555 H400	£472.00
MMIT-2 // RECTANGULAR TABLE	D555 W1295 H400	£726.00

TOP FINISHES



WAVE SWIVEL CHAIR

5 YR
COMPONENT
GUARANTEE

MADE
TO
ORDER
30 DAYS



- Upholstered tub chair
- Priced in Camira Advantage fabric. For other fabrics, please call our sales team

POLISHED ALUMINIUM 4 STAR BASE

	Dimensions	RRP
WA-1C // SWIVEL CHAIR	D740 W750 H960	£927.00 •

FR: Subject to selected fabric
Fabric: 100% Man-made

FABRIC FINISH



- Upholstered tub chair
- Leg finishes available in walnut stain or oak stain
- Priced in Camira Advantage fabric. For other fabrics, please call our sales team

WOODEN 4 STAR BASE

	Dimensions	RRP
WA-1W // SWIVEL CHAIR	D740 W750 H960	£1009.00 •

FR: Subject to selected fabric
Fabric: 100% Man-made

FABRIC FINISH



NOTE: Shown with walnut base

E&EO. All items are subject to VAT, where applicable.

SPIRIT LITE

5 YR
COMPONENT
GUARANTEE

MADE
TO
ORDER
30 DAYS



• Priced in Camira Advantage. For other fabrics, please call our sales team

SWIVEL BASE CHAIR

	Overall Dimensions	RRP
STL1C // 4 STAR SWIVEL BASE	D680 W570 H810	£488.00



FR: Subject to selected fabric
Fabric: 100% Man-made



• Priced in Camira Advantage. For other fabrics, please call our sales team

WIRE BASE CHAIR

	Overall Dimensions	RRP
STL2C // CHROME WIRE BASE	D680 W570 H810	£441.00



FR: Subject to selected fabric
Fabric: 100% Man-made



• Priced in Camira Advantage. For other fabrics, please call our sales team

CHROME PEDESTAL BASE CHAIR

	Overall Dimensions	RRP
STL3C // PEDESTAL SWIVEL BASE	D680 W570 H810	£542.00



FR: Subject to selected fabric
Fabric: 100% Man-made



• Priced in Camira Advantage. For other fabrics, please call our sales team

4-LEG STOOL

	Overall Dimensions	RRP
STS1C // 4-LEG STOOL	D490 W490 H1080	£429.00

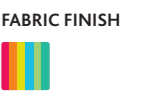

FR: Subject to selected fabric
Fabric: 100% Man-made



• Priced in Camira Advantage. For other fabrics, please call our sales team

SWIVEL BASE CHAIR WITH HEADREST

	Overall Dimensions	RRP
STL1C-HR // 4 STAR SWIVEL BASE	D680 W570 H940	£554.00



FR: Subject to selected fabric
Fabric: 100% Man-made



• Priced in Camira Advantage. For other fabrics, please call our sales team

WIRE BASE CHAIR WITH HEADREST

	Overall Dimensions	RRP
STL2C-HR // CHROME WIRE BASE	D680 W570 H940	£511.00



FR: Subject to selected fabric
Fabric: 100% Man-made



• Priced in Camira Advantage. For other fabrics, please call our sales team

CHROME PEDESTAL BASE CHAIR WITH HEADREST

	Overall Dimensions	RRP
STL3C-HR // PEDESTAL SWIVEL BASE	D680 W570 H940	£612.00



FR: Subject to selected fabric
Fabric: 100% Man-made



• Refer to trade price list. E&EO. All items are subject to VAT, where applicable.

SPIRIT ROCKING

5 YR
COMPONENT
GUARANTEE

MADE
TO
ORDER
30 DAYS



- Other wooden leg finishes available, call for details
- Two tone upholstery available as an optional extra, call for details
- Priced in Camira Advantage fabric. For other fabrics, please call our sales team

SPIRIT ROCKING CHAIR

	Dimensions	RRP
STLR1B // BLACK WIRE BASE	D770 W610 H790	£596.00 •
STLR1P // SILVER WIRE BASE	D770 W610 H790	POA •
STLR1C // CHROME WIRE BASE	D770 W610 H790	POA •

FABRIC FINISH



FR: Subject to selected fabric
Fabric: 100% Man-made



- Glass top with chrome wire base

SPIRIT FROSTED GLASS TOP TABLE

	Dimensions	RRP
ST10C // FROSTED TOP	D680 W680 H420	£365.00 •



- Other wooden leg finishes available, call for details
- Two tone upholstery available as an optional extra, call for details
- Priced in Camira Advantage fabric. For other fabrics, please call our sales team

SPIRIT ROCKING ARMCHAIR

	Dimensions	RRP
STR1B // BLACK WIRE BASE	D770 W680 H820	£703.00 •
STR1P // SILVER WIRE BASE	D770 W680 H820	POA •
STR1C // CHROME WIRE BASE	D770 W680 H820	POA •

FABRIC FINISH



FR: Subject to selected fabric
Fabric: 100% Man-made

NOTE: Shown with chrome base



- Walnut laminated top with chrome wire base
- White, Maple, Light Oak and Black tops also available
- Black frame available on request

SPIRIT WOODEN TOP TABLE

	Dimensions	RRP
ST11C // WOODENTOP	D680 W680 H420	£275.00 •



- Other wooden leg finishes available, call for details
- Two tone upholstery available as an optional extra, call for details
- Priced in Camira Advantage fabric. For other fabrics, please call our sales team

SPIRIT ROCKING CHAIR WITH HEADREST

	Dimensions	RRP
STLR1B-HR // BLACK WIRE BASE	D770 W610 H920	£663.00 •
STLR1P-HR // SILVER WIRE BASE	D770 W610 H920	POA •
STLR1C-HR // CHROME WIRE BASE	D770 W610 H920	POA •

FABRIC FINISH



FR: Subject to selected fabric
Fabric: 100% Man-made



PHONIC HIGH & PHONIC LOW



PHONIC HIGH ARMCHAIR

5^{YR} COMPONENT GUARANTEE	2^{YR} UPHOLSTERY GUARANTEE	115^{KG} WEIGHT TOLERANCE	8^H HOURS USAGE	MADE TO ORDER 42 DAYS
---	--	--	--	---



- An armchair with solid high arms and back to provide privacy and noise reduction while working
- Optional power module ensures you can keep working
- Stylish chrome feet
- Priced in Camira Advantage fabric. For other fabrics, please call our sales team

	Seat Dimensions	Back Dimensions	RRP	Unlimited Fabric Available
OF3901 // ARMCHAIR	D550 W550 H450	W550 H850	£1313.00	Please call for pricing

FR: Subject to fabric selected
Material: 100% Man-made



PHONIC HIGH 3 SEATER

5^{YR} COMPONENT GUARANTEE	2^{YR} UPHOLSTERY GUARANTEE	345^{KG} WEIGHT TOLERANCE	8^H HOURS USAGE	MADE TO ORDER 42 DAYS
---	--	--	--	---



- A 3 seater sofa with solid high arms and back to provide privacy and noise reduction while working
- Optional power module ensures you can keep working
- Stylish chrome feet
- Priced in Camira Advantage fabric. For other fabrics, please call our sales team

	Seat Dimensions	Back Dimensions	RRP	Unlimited Fabric Available
OF3903 // 3 SEATER	D550 W1650 H490	W1650 H850	£1534.00	Please call for pricing

FR: Subject to fabric selected
Material: 100% Man-made

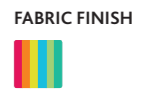

PHONIC HIGH 2 SEATER

5^{YR} COMPONENT GUARANTEE	2^{YR} UPHOLSTERY GUARANTEE	230^{KG} WEIGHT TOLERANCE	8^H HOURS USAGE	MADE TO ORDER 42 DAYS
---	--	--	--	---



- A 2 seater sofa with solid high arms and back to provide privacy and noise reduction while working
- Optional power module ensures you can keep working
- Stylish chrome feet
- Priced in Camira Advantage fabric. For other fabrics, please call our sales team

	Seat Dimensions	Back Dimensions	RRP	Unlimited Fabric Available
OF3902 // 2 SEATER	D550 W1100 H450	W1100 H850	£1366.00	Please call for pricing

FR: Subject to fabric selected
Material: 100% Man-made



INFILL PANEL & TABLE

5^{YR} COMPONENT GUARANTEE	2^{YR} UPHOLSTERY GUARANTEE	MADE TO ORDER 42 DAYS
---	--	---



- A single leg table for use with the Phonic infill panel
- Supplied with all fittings needed
- Priced in Camira Advantage fabric. For other fabrics, please call our sales team

	Dimensions	RRP	Unlimited Fabric Available
OF3903FUI // INFILL PANEL	W1000 H1275	£549.00	Please call for pricing
OF0903TAB // TABLE	D910 - 400 W1400 H1275	£298.00	

FR: Subject to fabric selected (infill panel only)



PHONIC LOW ARMCHAIR

5^{YR} COMPONENT GUARANTEE	2^{YR} UPHOLSTERY GUARANTEE	115^{KG} WEIGHT TOLERANCE	5^H HOURS USAGE	MADE TO ORDER 42 DAYS
---	--	--	--	---



- An armchair with solid arms and back to provide privacy and noise reduction while working
- Optional power module ensures you can keep working
- Stylish chrome feet
- Priced in Camira Advantage fabric. For other fabrics, please call our sales team

	Seat Dimensions	Back Dimensions	RRP	Unlimited Fabric Available
OF3900 // ARMCHAIR	D550 W550 H450	W550 H490	£1095.00	Please call for pricing

FR: Subject to fabric selected
Material: 100% Man-made



PHONIC LOW 2 SEATER

5^{YR} COMPONENT GUARANTEE	2^{YR} UPHOLSTERY GUARANTEE	230^{KG} WEIGHT TOLERANCE	5^H HOURS USAGE	MADE TO ORDER 42 DAYS
---	--	--	--	---



- A 2 seater sofa with solid arms and back to provide privacy and noise reduction while working
- Optional power module ensures you can keep working
- Stylish chrome feet
- Priced in Camira Advantage fabric. For other fabrics, please call our sales team

	Seat Dimensions	Back Dimensions	RRP	Unlimited Fabric Available
OF3904 // 2 SEATER	D550 W1100 H450	W1100 H490	£1204.00	Please call for pricing

FR: Subject to fabric selected
Material: 100% Man-made



PHONIC LOW 3 SEATER

5^{YR} COMPONENT GUARANTEE	2^{YR} UPHOLSTERY GUARANTEE	345^{KG} WEIGHT TOLERANCE	5^H HOURS USAGE	MADE TO ORDER 42 DAYS
---	--	--	--	---



- A 3 seater sofa with solid arms and back to provide privacy and noise reduction while working
- Optional power module ensures you can keep working
- Stylish chrome feet
- Priced in Camira Advantage fabric. For other fabrics, please call our sales team

	Seat Dimensions	Back Dimensions	RRP	Unlimited Fabric Available
OF3905 // 3 SEATER	D550 W1650 H450	W1650 H490	£1425.00	Please call for pricing

FR: Subject to fabric selected
Material: 100% Man-made



POWER MODULE



- Circular power port to fit the Phonic or Button range of meeting pods
- Featuring one UK plug socket and two USB sockets
- Power module enables flexible working anywhere
- Supplied with all fixings needed
- Priced in Camira Advantage fabric. For other fabrics, please call our sales team

	RRP
PM2BK // POWER MODULE (power cable sold separately)	£183.00
PMCB3M // 3M POWER CABLE	£30.00

Power module cable: 1 x UK socket, 2 x smart charge, 500mm lead, 3m length



BUTTON ARMCHAIR

5^{YR} COMPONENT GUARANTEE	2^{YR} UPHOLSTERY GUARANTEE	115^{KG} WEIGHT TOLERANCE	5^H HOURS USAGE	MADE TO ORDER 42 DAYS
---	--	--	--	---



- A chunky armchair with optional built-in power modules
- Coloured button upholstery detailing and silver feet complete the look
- Priced in Camira Advantage fabric. For other fabrics, please call our sales team

	Seat Dimensions	Back Dimensions	RRP	Unlimited Fabric Available
OF1701 // ARMCHAIR	D530 W600 H430	W600 H340	£850.00	Please call for pricing

FR: Subject to fabric selected
Material: 100% Man-made

FABRIC FINISH



BUTTON 2 SEATER

5^{YR} COMPONENT GUARANTEE	2^{YR} UPHOLSTERY GUARANTEE	230^{KG} WEIGHT TOLERANCE	5^H HOURS USAGE	MADE TO ORDER 42 DAYS
---	--	--	--	---



- A chunky 2 seater sofa with optional built-in power modules
- Coloured button upholstery detailing and silver feet complete the look
- Priced in Camira Advantage fabric. For other fabrics, please call our sales team

	Seat Dimensions	Back Dimensions	RRP	Unlimited Fabric Available
OF1702 // 2 SEATER	D530 W1200 H430	W1200 H340	£1095.00	Please call for pricing

FR: Subject to fabric selected
Material: 100% Man-made

FABRIC FINISH



BUTTON 3 SEATER

5^{YR} COMPONENT GUARANTEE	2^{YR} UPHOLSTERY GUARANTEE	345^{KG} WEIGHT TOLERANCE	5^H HOURS USAGE	MADE TO ORDER 42 DAYS
---	--	--	--	---



- A chunky 3 seater sofa with optional built-in power modules
- Coloured button upholstery detailing and silver feet complete the look
- Priced in Camira Advantage fabric. For other fabrics, please call our sales team

	Seat Dimensions	Back Dimensions	RRP	Unlimited Fabric Available
OF1703 // 3 SEATER	D530 W1800 H430	W1800 H340	£1313.00	Please call for pricing

FR: Subject to fabric selected
Material: 100% Man-made

FABRIC FINISH



INTRO MODULAR SEATING



INTRO MODULAR SEATING

5 YR
COMPONENT
GUARANTEE

MADE
TO
ORDER
30 DAYS



SINGLE BENCH

	RRP
INT300	£287.00
H430 W770 D770	



DOUBLE BENCH

	RRP
INT304	£412.00
H430 W1200 D770	



TREBLE BENCH

	RRP
INT320	£500.00
H430 W1520 D770	



45° LINK - NO LEG

	RRP
INT308	£305.00
H430 W570 D770	



90° LINK - WITH LEG

	RRP
INT309	£375.00
H430 W770 D770	



90° END - CENTRAL LEG / END LEG

	RRP
INT310	£421.00
H430 W770 H770	



SINGLE CHAIR

	RRP
INT301	£401.00
H770 W770 D770	



DOUBLE CHAIR

	RRP
INT321	£534.00
LEFT HAND	
INT322	£534.00
RIGHT HAND	
H770 W1220 D770	



DOUBLE CHAIR FULL BACK

	RRP
INT305	£599.00
H770 W1220 D770	



FREE STANDING ARM

	RRP
INT330	£338.00
H570 W270 D770	



FREE STANDING ARM WITH POWER

	RRP
INT331	£723.00
H570 W270 D770	

	RRP
INT/LINK	£23.00
LINKING KIT	
Consists of: 2 x Linking plates 8 x M6x25 screws	

- Sled base with felt pads
- Satin silver base finish is standard
- Chrome finish and two tone upholstery are also available at an extra cost. Please call for details

FABRIC FINISH

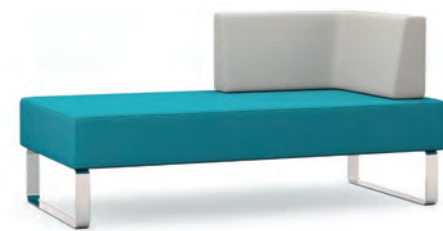

DOUBLE CHAIR CORNER ARM

	RRP
INT323	£676.00
LEFT HAND	
INT324	£676.00
RIGHT HAND	
H770 W1520 D770	



SINGLE CHAIR CORNER ARM

	RRP
INT302	£502.00
LEFT HAND	
INT303	£502.00
RIGHT HAND	
H770 W770 D770	

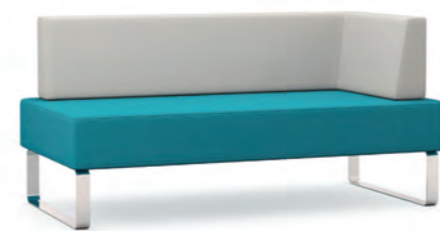

DOUBLE CHAIR FULL BACK CORNER

	RRP
INT306	£713.00
LEFT HAND	
INT307	£713.00
RIGHT HAND	
H770 W1520 D770	



NOTE: Shown in two tone upholstery which is 10% extra

• Refer to trade price list. E&EO. All items are subject to VAT, where applicable.

EVO PLUS MODULAR SEATING



EVO PLUS MODULAR SEATING

5 YR
COMPONENT
GUARANTEE

MADE
TO
ORDER
25 DAYS



ONE SEATER

	RRP
EVOP1 600 WIDE	£476.00
EVOP2 700 WIDE	£607.00

H450 W600 / 700 D700



TWO SEATER

	RRP
EVOP3	£632.00

H450 W1200 D700



THREE SEATER

	RRP
EVOP4	£768.00

H450 W1700 D700



45° SEAT

	RRP
EVOP5	£523.00

H450 W555 D700

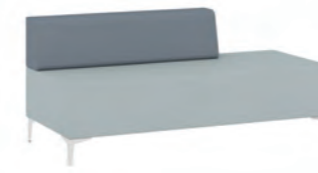

3 SEATER 2/3 BACK

	RRP
EVOP18 L/H	£1098.00
EVOP19 R/H	£1098.00

H750 W1700 D700



3 SEATER MIDDLE THIRD

	RRP
EVOP20	£1005.00

H750 W1700 D700



1 SEATER FULL BACK

	RRP
EVOP21 L/H	£897.00
EVOP24 R/H	£897.00

H750 W750 D700



2 SEATER FULL BACK

	RRP
EVOP22 L/H	£1161.00
EVOP25 R/H	£1161.00

H750 W1350 D700



90° SEAT

	RRP
EVOP6	£659.00

H450 W990 D700



180° SEAT

	RRP
EVOP7	£889.00

H450 W1400 D700



90° CURVED SEAT

	RRP
EVOP8	£1047.00

H450 W1400 D1400



ONE SEATER FULL BACK

	RRP
EVOP9 600 WIDE	£712.00
EVOP10 700 WIDE	£893.00

H750 W600 / 700 D700



3 SEATER FULL BACK

	RRP
EVOP23 L/H	£1434.00
EVOP26 R/H	£1434.00

H750 W1850 D700



2 SEATER HALF BACK

	RRP
EVOP27 L/H	£1053.00
EVOP29 R/H	£1053.00

H750 W1350 D700

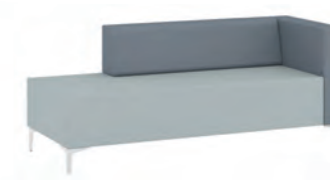

3 SEATER 2/3 BACK

	RRP
EVOP28 L/H	£1295.00
EVOP30 R/H	£1295.00

H750 W1850 D700



1 SEATER FULL BACK

	RRP
EVOP31 WITH ARMS	£1080.00

H750 W900 D700



2 SEATER FULL BACK

	RRP
EVOP11	£976.00

H750 W1200 D700

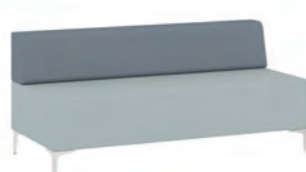

3 SEATER FULL BACK

	RRP
EVOP12	£1255.00

H750 W1700 D700



CORNER WITH FULL BACK

	RRP
EVOP13	£1168.00

H750 W700 D700



90° CURVED FULL BACK

	RRP
EVOP14	£1733.00

H750 W1400 D1400



2 SEATER FULL BACK

	RRP
EVOP32 WITH ARMS	£1342.00

H750 W1500 D700



3 SEATER FULL BACK

	RRP
EVOP33 WITH ARMS	£1619.00

H750 W2000 D700

Leg options		RRP
SWBEL	Square wooden beech leg	POA
SWWAL	Square wooden walnut leg	POA
SWWEL	Square wooden wenge leg	POA
SWWHL	Square wooden white leg	POA
CWBEL	Circular wooden beech leg	POA
CWWAL	Circular wooden walnut leg	POA
CWWEL	Circular wooden wenge leg	POA
CWWHL	Circular wooden white leg	POA

Linking		RRP
FTLP	Linking kit	£25.00

FABRIC FINISH



90° CONVEX CURVED

	RRP
EVOP36	£1632.00

H750 W1400 D1400



180° WITH BACK

	RRP
EVOP15	£1122.00

H750 W1400 D700



2 SEATER CORNER

	RRP
EVOP35 L/H	£1211.00
EVOP34 R/H	£1211.00

H750 W1200 D700



2 SEATER HALF BACK

	RRP
EVOP16 L/H	£869.00
EVOP17 R/H	£869.00

H750 W1200 D700

- Extensive range for layout options
- Use stand alone or linked
- Chairs with backs have sprung seats for extra comfort.

• Refer to trade price list. E&EO. All items are subject to VAT, where applicable.

EVO PLUS MEDIUM BACK



5 YR
COMPONENT
GUARANTEE

MADE
TO
ORDER
25 DAYS

EVO PLUS MEDIUM BACK



1 SEATER FULL BACK

	RRP
EVOPMB9 600 WIDE	£982.00
EVOPMB10 700 WIDE	£1197.00
H1050 W600 / 700 D700	



2 SEATER FULL BACK

	RRP
EVOPMB11	£1355.00
H1050 W1200 D700	



3 SEATER FULL BACK

	RRP
EVOPMB12	£1783.00
H1050 W1700 D700	



CORNER WITH FULL BACK

	RRP
EVOPMB13	£1753.00
H1050 W700 D700	



2 SEATER FULL BACK

	RRP
EVOPMB32 WITH AMRS	£2033.00
H1050 W1500 D700	



3 SEATER FULL BACK

	RRP
EVOPMB33 WITH ARMS	£2393.00
H1050 W2000 D700	



1 SEATER PRIVACY PANEL

	RRP
EVOPMBP1	£1367.00
Panel size - H1050 W1000	
Table size - W650 D750	



2 SEATER PRIVACY PANEL

	RRP
EVOPMBP2	£1420.00
Panel size - H1050 W1000	
Table size - W1000 D750	



90° CURVED FULL BACK

	RRP
EVOPMB14	£2401.00
H1050 W1400 D1400	



90° CONVEX CURVED

	RRP
EVOPMB36	£2189.00
H1050 W1400 D1400	



3 SEATER MIDDLE THIRD

	RRP
EVOPMB20	£1276.00
H1050 W1700 D700	



2 SEATER FULL CORNER

	RRP
EVOPMB35 L/H	£1796.00
EVOPMB34 R/H	£1796.00
H1050 W1200 D700	



3 SEATER PRIVACY PANEL

	RRP
EVOPMBP3	£1471.00
Panel size - H1050 W1000	
Table size - W1500 D750	

Leg options	RRP	Table frame finishes	RRP
SWBEL Square wooden beech leg	POA	TLSF Silver frame	POA
SWWAL Square wooden walnut leg	POA	TLBF Black frame	POA
SWWEL Square wooden wenge leg	POA	TLBGF Black Graphite	POA
SWWHL Square wooden white leg	POA	TLWF White frame	POA
CWBEL Circular wooden beech leg	POA	TLCF Chrome effect frame	POA
CWWAL Circular wooden walnut leg	POA		
CWWEL Circular wooden wenge leg	POA		
CWWHL Circular wooden white leg	POA		
Linking		RRP	
FTLP Linking kit			£25.00

TABLE MFC FINISHES



FABRIC FINISH



2 SEATER HALF BACK

	RRP
EVOPMB16 L/H	£1141.00
EVOPMB17 R/H	£1141.00
H1050 W1200 D700	



3 SEATER 2/3 BACK

	RRP
EVOPMB18 L/H	£1476.00
EVOPMB19 R/H	£1476.00
H1050 W1700 D700	



1 SEATER FULL BACK

	RRP
EVOPMB21 L/H	£1597.00
EVOPMB24 R/H	£1597.00
H1050 W750 700	



2 SEATER FULL BACK

	RRP
EVOPMB22 L/H	£1885.00
EVOPMB25 R/H	£1885.00
H1050 W1350 D700	



3 SEATER FULL BACK

	RRP
EVOPMB23 L/H	£2258.00
EVOPMB26 R/H	£2258.00
H1050 W1850 D700	



2 SEATER HALF BACK

	RRP
EVOPMB27 L/H	£1731.00
EVOPMB29 R/H	£1731.00
H1050 W1350 D700	



3 SEATER 2/3 BACK

	RRP
EVOPMB28 L/H	£2020.00
EVOPMB30 R/H	£2020.00
H1050 W1850 D700	



1 SEATER FULL BACK

	RRP
EVOPMB31 WITH ARMS	£1734.00
H1050 W900 D700	

• Refer to trade price list. E&EO. All items are subject to VAT, where applicable.

FIFTEEN DINER



FIFTEEN DINER

5 YR
COMPONENT
GUARANTEE

MADE
TO
ORDER
30 DAYS



2 SEATER LOW BACK

	RRP
15-E-20	£1230.00
H870 W780 D2020	

Table not included



4 SEATER LOW BACK

	RRP
15-E-40	£1913.00
H870 W1310 D2020	

Table not included



6 SEATER LOW BACK

	RRP
15-E-60	£3117.00
H870 W1910 H2020	

Table not included



2 SEATER HIGH BACK

	RRP
15-E-21	£1735.00
H1320 W780 D2020	

Table not included



4 SEATER HIGH BACK

	RRP
15-E-41	£2376.00
H1320 W1310 D2020	

Table not included



6 SEATER HIGH BACK

	RRP
15-E-61	£3503.00
H1320 W1910 D2020	

Table not included



SINGLE DINER TABLE

	RRP
15-E-1T	£325.00
H720 W670 D600	



DOUBLE DINER TABLE

	RRP
15-E-2T	£434.00
H720 W1200 D600	



TREBLE DINER TABLE

	RRP
15-E-3T	£650.00
H720 W1800 D600	

• Refer to trade price list. E&EO. All items are subject to VAT, where applicable.



TABLE MFC FINISHES



FABRIC FINISH



FIFTEEN MEDIA

5 YR
COMPONENT
GUARANTEE

MADE
TO
ORDER
30 DAYS



4 SEATER HIGH BACK MEDIA UNIT

	RRP
15-EM-41	£2809.00
H1320 W1310 D2020	
TV and Bracket NOT included	

6 SEATER HIGH BACK MEDIA UNIT

	RRP
15-EM-61	£4152.00
H1320 W1910 D2020	
TV and Bracket NOT included	

TV BRACKET

	RRP
15-TVB	£34.00
Bracket is suitable for TV's from 23" to 32" screens	



FIFTEEN PODS

5 YR
COMPONENT
GUARANTEE

MADE
TO
ORDER
30 DAYS



SINGLE SEAT POD

	RRP
15-E-P11	£1468.00
H1900 W860 D670	

DOUBLE SINGLE SEAT POD

	RRP
15-E-P12	£3427.00
H1900 W860 D2630	

2 SEATER POD

	RRP
15-E-P22	£1912.00
H1900 W1390 D670	



DOUBLE 2 SEATER POD

	RRP
15-E-P24	£4312.00
H1900 W1390 D2630	

TABLE MFC FINISHES



FABRIC FINISH



FENCE MODULAR SEATING



FENCE

5 YR
COMPONENT
GUARANTEE

MADE
TO
ORDER
30 DAYS



SINGLE ARMCHAIR

	RRP
FN-01	£797.00
H780 W900 D750	



2 SEATER SOFA

	RRP
FN-02	£1264.00
H780 W1500 D750	



3 SEATER SOFA

	RRP
FN-03	£1719.00
H780 W2250 D750	



5 SEATER L-SHAPED

	RRP
FN-35	£2855.00
H780 W2250 D2250	



5 SEATER L-SHAPED WITH SCREEN

	RRP
FN-45	£4063.00
H1440 W2370 D2370	



8 SEATER U-SHAPED

	RRP
FN-58	£4727.00
H780 W2250 D3000	



SINGLE ARMCHAIR WITH SCREEN

	RRP
FN-11	£1247.00
H1440 W1020 D810	



2 SEATER SOFA WITH SCREEN

	RRP
FN-12	£1867.00
H1440 W1620 D810	



3 SEATER SOFA WITH SCREEN

	RRP
FN-13	£2471.00
H1440 W2370 D810	



8 SEATER U-SHAPED WITH SCREEN

	RRP
FN-68	£6378.00
H1440 W2370 D3120	



PIXEL

		RRP
PX10	1 x UK socket (fused at 3.15A), 3 metre lead to 13A UK plug, black	£232.00
PX20	1 x UK socket (fused at 3.15A), twin USB fast charger (2.3A max load), 3 metre lead to 13A UK plug, black	£412.00

Options		RRP
C	Chrome legs	POA
NT	Beech wooden legs	POA
WL	Walnut wooden legs	POA

FABRIC FINISH



2 SEATER BOOTH

	RRP
FN-22	£2644.00
H1440 W1020 D2430	



4 SEATER BOOTH

	RRP
FN-24	£3883.00
H1440 W1620 D2430	



6 SEATER BOOTH

	RRP
FN-26	£5093.00
H1440 W2370 D2430	



• Refer to trade price list. E&EO. All items are subject to VAT, where applicable.

TUX ARMCHAIR

5 YR COMPONENT GUARANTEE	2 YR UPHOLSTERY GUARANTEE	115 KG WEIGHT TOLERANCE	5 H HOURS USAGE
---------------------------------------	--	--------------------------------------	------------------------------



- Comfortable and plush armchair with chrome feet
- Deep foam seat and back
- Optional cushions available in 4 colours

	Seat Dimensions	Back Dimensions	RRP
OF0706 // ARMCHAIR	D530 W520 H460	W530 H320	£549.00

FR: Low
Material: 100% Man-made

FABRIC FINISHES



TUX 3 SEATER

5 YR COMPONENT GUARANTEE	2 YR UPHOLSTERY GUARANTEE	230 KG WEIGHT TOLERANCE	5 H HOURS USAGE
---------------------------------------	--	--------------------------------------	------------------------------



- Comfortable and plush sofa with chrome feet
- Deep foam seat and back
- Optional cushions available in 4 colours

	Seat Dimensions	Back Dimensions	RRP
OF0707 // 3 SEATER	D530 W1610 H460	W1600 H320	£680.00

FR: Low
Material: 100% Man-made

FABRIC FINISHES



CUSHIONS

2YR
UPHOLSTERY
GUARANTEE



	Dimensions	RRP
OF0708 // CUSHIONS	D34 W340 T120	£19.00

FR: Low
Material: 100% Man-made

FABRIC FINISHES



ICEBERG ARMCHAIR

5 YR COMPONENT GUARANTEE	2 YR UPHOLSTERY GUARANTEE	115 KG WEIGHT TOLERANCE	5 H HOURS USAGE
---------------------------------------	--	--------------------------------------	------------------------------



- A modern leather-faced armchair with silver metal feet
- Deep cushions and arms

	Seat Dimensions	Back Dimensions	RRP
OF0300 // ARMCHAIR	D530 W540 H450	W580 H360	£467.00

FR: Low
Fabric: Leather faced

FINISH

BK

ICEBERG SOFA

5 YR COMPONENT GUARANTEE	2 YR UPHOLSTERY GUARANTEE	230 KG WEIGHT TOLERANCE	5 H HOURS USAGE
---------------------------------------	--	--------------------------------------	------------------------------



- A modern leather-faced 2 seater sofa with silver metal feet
- Deep cushions and arms

	Seat Dimensions	Back Dimensions	RRP
OF0301 // SOFA	D530 W1090 H450	W1090 H360	£658.00

FR: Low
Fabric: Leather faced

FINISH

BK

MOONSTONE ARMCHAIR

5 YR COMPONENT GUARANTEE	2 YR UPHOLSTERY GUARANTEE	115 KG WEIGHT TOLERANCE	5 H HOURS USAGE
---------------------------------------	--	--------------------------------------	------------------------------



- A modern leather-faced armchair with silver metal feet
- Deep cushions and arms

	Seat Dimensions	Back Dimensions	RRP
MS1/BL // ARMCHAIR	D560 W510 H430	W535 H370	£693.00

FR: Low
Fabric: Leather faced

FINISH

BK

MOONSTONE SOFA

5 YR COMPONENT GUARANTEE	2 YR UPHOLSTERY GUARANTEE	230 KG WEIGHT TOLERANCE	5 H HOURS USAGE
---------------------------------------	--	--------------------------------------	------------------------------



- A modern leather-faced 2 seater sofa with silver metal feet
- Deep cushions and arms

	Seat Dimensions	Back Dimensions	RRP
MS2/DBL // SOFA	D570 W1100 H430	W1100 H375	£941.00

FR: Low
Fabric: Leather faced

FINISH

BK

FACE ARMCHAIR

2YR
COMPONENT
GUARANTEE



- KD for easy delivery

	Overall Dimensions	RRP
FA1/BL // ARMCHAIR	D775 W785 H850	£259.00

FR: Low
Fabric: Leather look

FABRIC FINISH

BK

FACE COFFEE TABLE

2YR
COMPONENT
GUARANTEE



	Overall Dimensions	RRP
FATAB/BCH/BLK // COFFEE TABLE	D610 W610 H390	£130.00

FR: Low
Fabric: Leather look

FABRIC FINISH // TOP FINISH

BK // BE

FACE 2 SEATER SOFA

2YR
COMPONENT
GUARANTEE



- KD for easy delivery

	Overall Dimensions	RRP
FA2/BL // SOFA	D775 W1305 H850	£310.00

FR: Low
Fabric: Leather look

FABRIC FINISH

BK

TANDEM 2 SEATER BENCH

5 YR COMPONENT GUARANTEE	2 YR UPHOLSTERY GUARANTEE	114 KG WEIGHT TOLERANCE	MADE TO ORDER 25 DAYS
---------------------------------------	--	--------------------------------------	---



- Simple and stylish breakout seating
- Satin silver feet with felt pads
- Power socket option available, contact sales for details

	Overall Dimensions	RRP	Unlimited Fabric Available
TND01 // 2 SEATER BENCH	D430 W1230 H450	£276.00	Please call for pricing

FR: Subject to fabric selected
Material: 100% Man-made

FABRIC FINISH



TANDEM LINK

5 YR COMPONENT GUARANTEE	2 YR UPHOLSTERY GUARANTEE	114 KG WEIGHT TOLERANCE	MADE TO ORDER 25 DAYS
---------------------------------------	--	--------------------------------------	---



- Simple and stylish breakout seating
- Satin silver feet with felt pads
- Power socket option not available

	Overall Dimensions	RRP	Unlimited Fabric Available
TND02 // LINK	D430 W430 H450	£219.00	Please call for pricing

FR: Subject to fabric selected
Material: 100% Man-made

FABRIC FINISH



TUB ARMCHAIR



5 YR COMPONENT GUARANTEE	2 YR UPHOLSTERY GUARANTEE	115 KG WEIGHT TOLERANCE	5 H HOURS USAGE
---------------------------------------	--	--------------------------------------	------------------------------

- A stylish and comfortable armchair upholstered in fabric
- Plush cushioned back with stylish stitching detail

	Seat Dimensions	Back Dimensions	RRP
OF0101 // ARMCHAIR	D530 W500 H415	W550 H355	£303.00

FR: Med
Fabric: 100% Man-made

FABRIC FINISHES



TUB LEATHER LOOK ARMCHAIR



5 YR COMPONENT GUARANTEE	2 YR UPHOLSTERY GUARANTEE	115 KG WEIGHT TOLERANCE	5 H HOURS USAGE
---------------------------------------	--	--------------------------------------	------------------------------

- A stylish and comfortable armchair upholstered in durable PU
- Plush cushioned back with stylish stitching detail

	Seat Dimensions	Back Dimensions	RRP
OF0201 // ARMCHAIR	D530 W500 H415	W550 H355	£303.00

FR: Med
Fabric: Leather look

FINISH



TUB SOFA



5 YR COMPONENT GUARANTEE	2 YR UPHOLSTERY GUARANTEE	230 KG WEIGHT TOLERANCE	5 H HOURS USAGE
---------------------------------------	--	--------------------------------------	------------------------------

- A comfortable and durable 2 seater sofa, ideal for any waiting area or break room
- Plush cushioned back with stylish stitching detail

	Seat Dimensions	Back Dimensions	RRP
OF0100 // SOFA	D520 W1100 H415	W550 H355	£549.00

FR: Med
Fabric: 100% Man-made

FABRIC FINISHES



TUB LEATHER LOOK SOFA



5 YR COMPONENT GUARANTEE	2 YR UPHOLSTERY GUARANTEE	230 KG WEIGHT TOLERANCE	5 H HOURS USAGE
---------------------------------------	--	--------------------------------------	------------------------------

- A comfortable and durable 2 seater PU sofa, ideal for any waiting area or break room
- Plush cushioned back with stylish stitching detail

	Seat Dimensions	Back Dimensions	RRP
OF0200 // SOFA	D520 W1100 H415	W550 H355	£549.00

FR: Med
Fabric: Leather look

FINISH



TUB LUX ARMCHAIR METAL

2 YR COMPONENT GUARANTEE	2 YR UPHOLSTERY GUARANTEE	115 KG WEIGHT TOLERANCE	5 H HOURS USAGE
---------------------------------------	--	--------------------------------------	------------------------------



- Stylish tub armchair, available in 11 exciting colours
- Deep cushioned seat and back upholstered in PU
- Available in yellow, lime, cream, blue, brown, green, orange, pink, red, sky blue & black

	Seat Dimensions	Back Dimensions	RRP
OF2201ML // ARMCHAIR	D520 W500 H400	W600 H460	£330.00

FR: Med
Fabric: Leather look

FINISHES



TUB LUX ARMCHAIR WOOD

2 YR COMPONENT GUARANTEE	2 YR UPHOLSTERY GUARANTEE	115 KG WEIGHT TOLERANCE	5 H HOURS USAGE
---------------------------------------	--	--------------------------------------	------------------------------



- Stylish tub armchair, available in 11 exciting colours
- Deep cushioned seat and back upholstered in PU
- Available in yellow, lime, cream, blue, brown, green, orange, pink, red, sky blue & black

	Seat Dimensions	Back Dimensions	RRP
OF2201WL // ARMCHAIR	D520 W500 H400	W600 H460	£330.00

FR: Med
Fabric: Leather look

FINISHES



TUB LUX SOFA METAL

2 YR COMPONENT GUARANTEE	2 YR UPHOLSTERY GUARANTEE	230 KG WEIGHT TOLERANCE	5 H HOURS USAGE
---------------------------------------	--	--------------------------------------	------------------------------



- Stylish tub armchair, available in 11 exciting colours
- Deep cushioned seat and back upholstered in PU
- Available in yellow, lime, cream, blue, brown, green, orange, pink, red, sky blue & black

	Seat Dimensions	Back Dimensions	RRP
OF2200ML // SOFA	D520 W1070 H400	W1070 H380	£567.00

FR: Low
Fabric: Leather faced

FINISHES



TUB LUX SOFA WOOD

2 YR COMPONENT GUARANTEE	2 YR UPHOLSTERY GUARANTEE	230 KG WEIGHT TOLERANCE	5 H HOURS USAGE
---------------------------------------	--	--------------------------------------	------------------------------



- Stylish tub armchair, available in 11 exciting colours
- Deep cushioned seat and back upholstered in PU
- Available in yellow, lime, cream, blue, brown, green, orange, pink, red, sky blue & black

	Seat Dimensions	Back Dimensions	RRP
OF2200WL // SOFA	D520 W1070 H400	W1070 H380	£567.00

FR: Low
Fabric: Leather faced

FINISHES



NURSERY TUB CHAIRS

2 YR COMPONENT GUARANTEE	2 YR UPHOLSTERY GUARANTEE	95 KG WEIGHT TOLERANCE	5 H HOURS USAGE
---------------------------------------	--	-------------------------------------	------------------------------



- Available in yellow, lime, blue, brown, orange, pink, red, light blue & black
- A miniature version of the classic tub chair
- Perfect for libraries and breakout areas

	Seat Dimensions	Back Dimensions	RRP
OF22031ML // NURSERY TUB	D410 W350 H270	W410 H260	£171.00

FR: Med
Fabric: Leather look

FINISHES



JUNIOR TUB CHAIRS

2 YR COMPONENT GUARANTEE	2 YR UPHOLSTERY GUARANTEE	95 KG WEIGHT TOLERANCE	5 H HOURS USAGE
---------------------------------------	--	-------------------------------------	------------------------------



- Available in yellow, lime, blue, brown, orange, pink, red, light blue & black
- A miniature version of the classic tub chair
- Perfect for libraries and breakout areas

	Seat Dimensions	Back Dimensions	RRP
OF2203ML // JUNIOR TUB	D410 W350 H340	W410 H260	£196.00

FR: Med
Fabric: Leather look

FINISHES



JUNIOR WOOD TUB CHAIRS

2 YR COMPONENT GUARANTEE	2 YR UPHOLSTERY GUARANTEE	95 KG WEIGHT TOLERANCE	5 H HOURS USAGE
---------------------------------------	--	-------------------------------------	------------------------------



- Available in yellow, lime, blue, brown, orange, pink, red, light blue & black
- A miniature version of the classic tub chair
- Perfect for libraries and breakout areas

	Seat Dimensions	Back Dimensions	RRP
OF22031WL // JUNIOR WOOD TUB	D410 W350 H340	W410 H260	£196.00

FR: Med
Fabric: Leather look

FINISHES



NOTE: Cushions not sold separately

JADE

5 YR
COMPONENT
GUARANTEE

2 YR
UPHOLSTERY
GUARANTEE

115 KG
WEIGHT
TOLERANCE

5 H
HOURS
USAGE



• Available in grey, navy and mustard

	Seat Dimensions	Back Dimensions	RRP
OF0704 // ARMCHAIR	D540 W600 H435	W600 H440	£244.00

FR: Med
Fabric: 100% Man-made

FABRIC FINISHES



RUBY

5 YR
COMPONENT
GUARANTEE

2 YR
UPHOLSTERY
GUARANTEE

115 KG
WEIGHT
TOLERANCE

5 H
HOURS
USAGE



• Available in grey, navy, mustard and red

	Seat Dimensions	Back Dimensions	RRP
OF0709 // ARMCHAIR	D470 W490 H460	W400 H360	£182.00

FR: Med
Fabric: 100% Man-made

FABRIC FINISHES



PEARL

5 YR
COMPONENT
GUARANTEE

2 YR
UPHOLSTERY
GUARANTEE

115 KG
WEIGHT
TOLERANCE

5 H
HOURS
USAGE



• Available in grey, navy and mustard

	Seat Dimensions	Back Dimensions	RRP
OF0705 // ARMCHAIR	D490 W500 H400	W570 H490	£234.00

FR: Med
Fabric: 100% Man-made

FABRIC FINISHES



JUPLO SIDE CHAIR



2 YR COMPONENT GUARANTEE	2 YR UPHOLSTERY GUARANTEE	115 KG WEIGHT TOLERANCE	8 ^H HOURS USAGE
---------------------------------------	--	--------------------------------------	---

- A sturdy wood-framed reception chair
- Generously upholstered seat and back
- Polished wood frame

	Seat Dimensions	Back Dimensions	RRP
OF0309 // SIDE CHAIR	D480 W520 H405	W520 H500	£330.00

FR: Med
Fabric: 100% Man-made

FABRIC FINISHES



JUPLO ARMCHAIR



2 YR COMPONENT GUARANTEE	2 YR UPHOLSTERY GUARANTEE	115 KG WEIGHT TOLERANCE	8 ^H HOURS USAGE
---------------------------------------	--	--------------------------------------	---

- A sturdy wood-framed reception armchair
- Generously upholstered seat and back
- Polished wood frame

	Seat Dimensions	Back Dimensions	RRP
OF0310 // ARMCHAIR	D480 W520 H405	W520 H500	£352.00

FR: Med
Fabric: 100% Man-made
Arms: Fixed

FABRIC FINISHES



JUPLO SOFA



2 YR COMPONENT GUARANTEE	2 YR UPHOLSTERY GUARANTEE	230 KG WEIGHT TOLERANCE	8 ^H HOURS USAGE
---------------------------------------	--	--------------------------------------	---

- A sturdy wood-framed reception sofa
- Generously upholstered seat and back
- Polished wood frame

	Seat Dimensions	Back Dimensions	RRP
OF0313 // ARMCHAIR	D485 W1060 H405	W1060 H535	£388.00

FR: Med
Fabric: 100% Man-made
Arms: Fixed

FABRIC FINISHES



GLACIER



5 YR COMPONENT GUARANTEE	2 YR UPHOLSTERY GUARANTEE	115 KG WEIGHT TOLERANCE	8 H HOURS USAGE
---------------------------------------	--	--------------------------------------	------------------------------

- Fully-upholstered modular reception chair
- Generously upholstered seat and back, black plastic feet

	Seat Dimensions	Back Dimensions	RRP
OF0601 // ARMCHAIR	D470 W610 H410	W610 H420	£222.00

FR: Med
Fabric: 100% Man-made

FABRIC FINISHES



GLACIER TABLE



5 YR COMPONENT GUARANTEE	2 YR UPHOLSTERY GUARANTEE	115 KG WEIGHT TOLERANCE
---------------------------------------	--	--------------------------------------

- Square low table with light beech top and upholstered sides
- Ideal for use with Glacier chairs
- Black plastic feet for stability

	Dimensions	RRP
OF0603 // TABLE	D620 W620 H370	£139.00

FR: Med
Fabric: 100% Man-made

FABRIC FINISHES



GLACIER ARM



5 YR COMPONENT GUARANTEE	2 YR UPHOLSTERY GUARANTEE	115 KG WEIGHT TOLERANCE	8 H HOURS USAGE
---------------------------------------	--	--------------------------------------	------------------------------

- Single arm for the Glacier range of modular reception seating
 - Fully upholstered and generously padded
 - Can be used as a left or right arm
- // NOTE: Sold as singles

	Dimensions	RRP
OF0602 // ARM	D650 W100 H600	£79.00

FR: Med
Fabric: 100% Man-made

FABRIC FINISHES



RUBIC



5 YR COMPONENT GUARANTEE	2 YR UPHOLSTERY GUARANTEE	115 KG WEIGHT TOLERANCE	8 H HOURS USAGE
---------------------------------------	--	--------------------------------------	------------------------------

- A comfortable and durable waiting room chair
- Deep foam seat and back with black metal legs

	Seat Dimensions	Back Dimensions	RRP
OF0307 // CHAIR	D550 W530 H430	W530 H390	£177.00

FR: Med
Fabric: 100% Man-made

FABRIC FINISHES



EDUCATION

// 19

Successful teaching rests on the premise that when it comes to learning, everything is always in a perpetual state of change. You need furniture that's going to support that, and you'll find it here.

CONTENTS

376	Nurture	396	T-Bag
378	Uni	398	Link
380	Study	400	KD Classroom Tables
382	Titan One Piece	402	Exam Desks & Folding Tables
384	Titan 4-Leg	404	IT Classroom Chairs
386	Titan Skid	406	Lab Chairs
388	Titan Teach & Move	408	Teacher Furniture
390	Titan High Chair	410	Staffroom
392	Titan Stool	411	Dining Hall Tables
394	Titan Swivel	412	Titan Accessories



NURTURE

- CLASSROOM SAFE
- STACKABLE 4-LEG
- 5**YR GUARANTEE
- 8**H HOURS USAGE



4-LEG

	Overall Dimensions	Seat Dimensions
T-NUR-4LEG	D560 W515 H875	D470 W470 H470



SWIVEL

	Overall Dimensions	Seat Dimensions
T-NUR-SWIVEL	D560 W515 H875	D470 W470 H435 - 525

Weight capacity: 115kg
Storage: Stacks 4

TOP FINISHES // FRAME FINISHES

- AC
- GO
- OK
- //
- BK
- WH

Weight capacity: 115kg
Mechanism: Fixed

TOP FINISHES // FRAME FINISHES

- AC
- GO
- OK
- //
- BK
- WH

ABOUT NURTURE

Nurture is a wooden range of contemporary classroom, stacking, canteen and conference chairs that aim to improve educational and public spaces through a connection with nature. This connection is proven to increase rates of learning, concentration and attendance by 25%. The range is crafted in the UK from layers of premium hardwood veneer, faced with hard wearing laminate and finished with Danish oil. It is also FSC tree tick approved which ensures the process of making this chair is environmentally appropriate.



UNI

CLASSROOM SAFE STACKABLE 5^{YR} GUARANTEE 8^H HOURS USAGE



4-LEG

	Overall Dimensions	Seat Dimensions
T-UNI-4LEG	D620 W545 H840	D460 W465 H440

Weight capacity: 115kg
Storage: Stacks 5

SEAT FINISHES // FRAME FINISHES

BK BL GR Y RGB // GR WH



SKID

	Overall Dimensions	Seat Dimensions
T-UNI-SKID	D525 W550 H860	D460 W465 H430

Weight capacity: 115kg
Storage: Stacks 5

SEAT FINISHES // FRAME FINISH

BK BL GR Y RGB // GR WH



4 LEG WITH ARM

	Overall Dimensions	Seat Dimensions
T-UNI-4LEGARM	D620 W545 H855	D460 W465 H445

Weight capacity: 115kg
Storage: Stacks 5

SEAT FINISHES // FRAME FINISHES

BK BL GR Y RGB // GR WH



HIGH

	Overall Dimensions	Seat Dimensions
T-UNI-HIGH	D595 W510 H1115	D460 W465 H705

Weight capacity: 115kg
Storage: Stacks 5

SEAT FINISHES // FRAME FINISHES

BK BL GR Y RGB // GR WH



SWIVEL

	Overall Dimensions	Seat Dimensions
T-UNI-SWIVEL	D620 W545 H860	D460 W465 H470 - 590

Weight capacity: 115kg

SEAT FINISHES // FRAME FINISHES

BK BL GR Y RGB // BK



SWIVEL + D-KIT

	Overall Dimensions	Seat Dimensions
T-UNI-SWIVEL+AC1080	D620 W545 H920	D460 W465 H530 - 830

Weight capacity: 115kg

SEAT FINISHES // FRAME FINISHES

BK BL GR Y RGB // BK



STUDY

CLASSROOM SAFE STACKABLE 5^{YR} GUARANTEE 8^H HOURS USAGE



BLACK

	Overall Dimensions	Seat Dimensions
T-STUDYBK	D550 W500 H815	D525 W450 H460



BLUE

	Overall Dimensions	Seat Dimensions
T-STUDY	D550 W500 H815	D525 W450 H460

Weight capacity: 115kg
Storage: Stacks 5

BK

Weight capacity: 115kg
Storage: Stacks 5

BL

ABOUT STUDY

Study is a practical heavy-duty chair that is perfect for halls, canteens, meeting rooms and cafeterias. It has a breathable back, a tensile steel frame and a curved polypropylene shell. This chair is ideal when space is a priority as it stacks 5 high. Available in a variety of colours this is a stylish take on a regular multipurpose chair.



ONE PIECE LINKING CLIP



T7 for One Piece size 5 & 6

TITAN ONE PIECE

ANTI-BACTERIAL
AVAILABLE ON REQUEST

CLASSROOM SAFE

LUMBAR SUPPORT

ANTI TILT

STACKABLE

ULTRA STRONG

20^{YR} GUARANTEE

8^H HOURS USAGE



SIZE 1 // AGES 3 - 4

	Overall Dimensions	Seat Dimensions
T1	D320 W360 H513	D279 W275 H260

Weight capacity: 97kg
Storage: Stacks 15



SIZE 2 // AGES 4 - 6

	Overall Dimensions	Seat Dimensions
T2	D343 W363 H563	D279 W275 H310

Weight capacity: 97kg
Storage: Stacks 15



SIZE 3 // AGES 6 - 8

	Overall Dimensions	Seat Dimensions
T3	D384 W435 H600	D331 W340 H350

Weight capacity: 107kg
Storage: Stacks 15



SIZE 4 // AGES 8 - 11

	Overall Dimensions	Seat Dimensions
T4	D408 W435 H690	D331 W340 H380

Weight capacity: 107kg
Storage: Stacks 15



SIZE 5 // AGES 11 - 14

	Overall Dimensions	Seat Dimensions
T5	D486 W480 H799	D414 W370 H430

Weight capacity: 115kg
Storage: Stacks 15



SIZE 6 // AGES 14+

	Overall Dimensions	Seat Dimensions
T6	D510 W482 H829	D414 W370 H460

Weight capacity: 158kg
Storage: Stacks 15





TITAN 4-LEG

- CLASSROOM SAFE
- LUMBAR SUPPORT
- ANTI TILT
- STACKABLE
- ULTRA STRONG
- 5^{YR} GUARANTEE
- 8^H HOURS USAGE



SIZE 2 // AGES 4 - 6

	Overall Dimensions	Seat Dimensions
T12	D398 W438 H630	D320 W387 H350



Weight capacity: 95kg



SIZE 3 // AGES 6 - 8

	Overall Dimensions	Seat Dimensions
T13	D398 W438 H670	D320 W387 H350



Weight capacity: 95kg



SIZE 4 // AGES 8 - 11

	Overall Dimensions	Seat Dimensions
T14	D416 W438 H700	D320 W387 H380



Weight capacity: 95kg



SIZE 5 // AGES 11 - 14

	Overall Dimensions	Seat Dimensions
T15	D477 W497 H790	D406 W423 H430



Weight capacity: 140kg



SIZE 6 // AGES 14+

	Overall Dimensions	Seat Dimensions
T16	D495 W497 H820	D406 W423 H460



Weight capacity: 140kg



TITAN SKID

- CLASSROOM SAFE
- LUMBAR SUPPORT
- ANTI TILT
- STACKABLE
- ULTRA STRONG
- 5^{YR} GUARANTEE
- 8^H HOURS USAGE



SIZE 3 // AGES 6 - 8

	Overall Dimensions	Seat Dimensions
T23	D368 W507 H660	D320 W387 H350



Weight capacity: 95kg



SIZE 4 // AGES 8 - 11

	Overall Dimensions	Seat Dimensions
T24	D386 W507 H700	D320 W387 H380



Weight capacity: 95kg



SIZE 5 // AGES 11 - 14

	Overall Dimensions	Seat Dimensions
T25	D456 W540 H806	D406 W423 H430



Weight capacity: 140kg



SIZE 6 // AGES 14+

	Overall Dimensions	Seat Dimensions
T26	D477 W540 H836	D406 W423 H460



Weight capacity: 140kg



TITAN TEACH & MOVE

- CLASSROOM SAFE
- LUMBAR SUPPORT
- ANTI TILT
- ULTRA STRONG
- 5^{YR} GUARANTEE
- 8^H HOURS USAGE



TEACH // AGES 14+

	Overall Dimensions	Seat Dimensions
T300	D900 W548 H845	D406 W423 H470

Back dimensions: D403 H400
 Tablet dimensions: D290/350 W548 H745
 Storage dimensions: D330 W490
 Weight capacity: 130kg

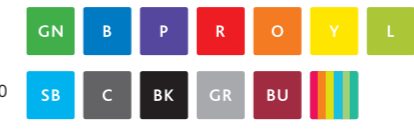

MOVE // AGES 14+

	Overall Dimensions	Seat Dimensions
T301	D460 W475 H845	D406 W423 H470

Back dimensions: W403 H400
 Weight capacity: 130kg





TITAN HIGH CHAIR

- CLASSROOM SAFE
- LUMBAR SUPPORT
- ULTRA STRONG
- 5^{YR} GUARANTEE
- 8^H HOURS USAGE



SIZE 2 // AGES 4 - 6

	Overall Dimensions	Seat Dimensions
T59	D530 W550 H770	D406 W423 H395

Weight capacity: 95kg



SIZE 3 // AGES 6 - 8

	Overall Dimensions	Seat Dimensions
T60	D530 W550 H820	D406 W423 H445

Weight capacity: 95kg



SIZE 4 // AGES 8 - 11

	Overall Dimensions	Seat Dimensions
T61	D530 W550 H920	D406 W423 H560

Weight capacity: 95kg



SIZE 5 // AGES 11 - 14

	Overall Dimensions	Seat Dimensions
T62	D530 W550 H970	D406 W423 H610

Weight capacity: 140kg



SIZE 6 // AGES 14+

	Overall Dimensions	Seat Dimensions
T63	D530 W550 H1020	D406 W423 H685

Weight capacity: 140kg





TITAN STOOL

- CLASSROOM SAFE
- LUMBAR SUPPORT
- STACKABLE
- ULTRA STRONG
- 5^{YR} GUARANTEE
- 8^H HOURS USAGE



SIZE 2 // AGES 4 - 6

	Overall Dimensions	Seat Dimensions
T89	D530 W550 H445	D361 W365 H395



Weight capacity: 97kg



SIZE 3 // AGES 6 - 8

	Overall Dimensions	Seat Dimensions
T90	D530 W550 H495	D361 W365 H445



Weight capacity: 97kg



SIZE 4 // AGES 8 - 11

	Overall Dimensions	Seat Dimensions
T91	D530 W550 H600	D361 W365 H560



Weight capacity: 97kg



SIZE 5 // AGES 11 - 14

	Overall Dimensions	Seat Dimensions
T92	D530 W550 H650	D361 W365 H610



Weight capacity: 107kg



SIZE 6 // AGES 14+

	Overall Dimensions	Seat Dimensions
T93	D530 W550 H725	D361 W365 H685



Weight capacity: 107kg



TITAN SWIVEL

- CLASSROOM SAFE
- LUMBAR SUPPORT
- HEIGHT ADJUSTABLE
- PORTABLE
- 5^{YR} GUARANTEE
- 8^H HOURS USAGE



// NOTE: Shown with optional glides

JUNIOR SWIVEL // AGES 6 - 11

	Overall Dimensions	Seat Dimensions
T30	D600 W600 H765 - 820	D320 W387 H365 - 435

Base diameter: 600
Weight capacity: 97kg



SENIOR SWIVEL // AGES 11+

	Overall Dimensions	Seat Dimensions
T35	D600 W600 H845 - 930	D406 W423 H435 - 525

Base diameter: 600
Weight capacity: 107kg



JUNIOR SWIVEL // AGES 6 - 11

	Overall Dimensions	Seat Dimensions
T32	D600 W600 H445 - 500	D390 W420 H405 - 475

Base diameter: 600
Weight capacity: 97kg



SENIOR SWIVEL // AGES 11+

	Overall Dimensions	Seat Dimensions
T33	D600 W600 H505 - 605	D414 W420 H465 - 555

Base diameter: 600
Weight capacity: 97kg



Available Options for Titan Swivel

- Black base and gas lif
- Glides



CLASSROOM SAFE
2 YR GUARANTEE
8 H HOURS USAGE

T BAG



GOLIATH

Overall Dimensions	
T-BAG-GOLIATH	D2000 W1320 H200

- Wipe clean cover
- No liner
- 15 cuft polybead filling



MEDIUM

Overall Dimensions	
T-BAG-MEDIUM	D750 W750 H650

- Easily removed wipe clean or dry clean cover
- 3.5 cuft polybead filling



FLOOR

Overall Dimensions	
T-BAG-FLOOR	W680 H680

- Easily removed machine washable cover
- 1.5 cuft polybead filling



LINK

5^{YR}
COMPONENT
GUARANTEE

12^{MM}
TOP
THICKNESS

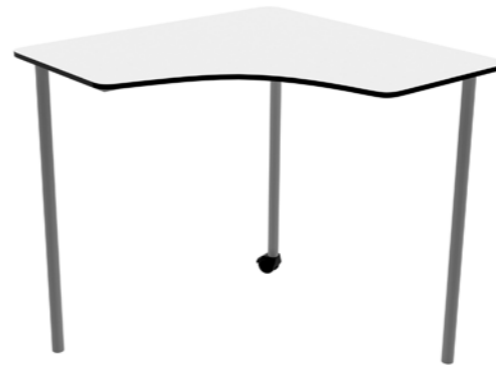

- Solid core 12mm laminate
- Create collaborative learning spaces
- Mobile

RECTANGULAR LINK

	Overall Dimensions
T-LINK-1260	D600 W1200 H760

Number of wheels: 2

SQUARE LINK

	Overall Dimensions
T-LINK-8060	D800 W800 H760

Number of wheels: 2

CORNER LINK

	Overall Dimensions
T-LINK-11172	D800 W1100 H760

Number of wheels: 1

TOP FINISH // FRAME FINISH

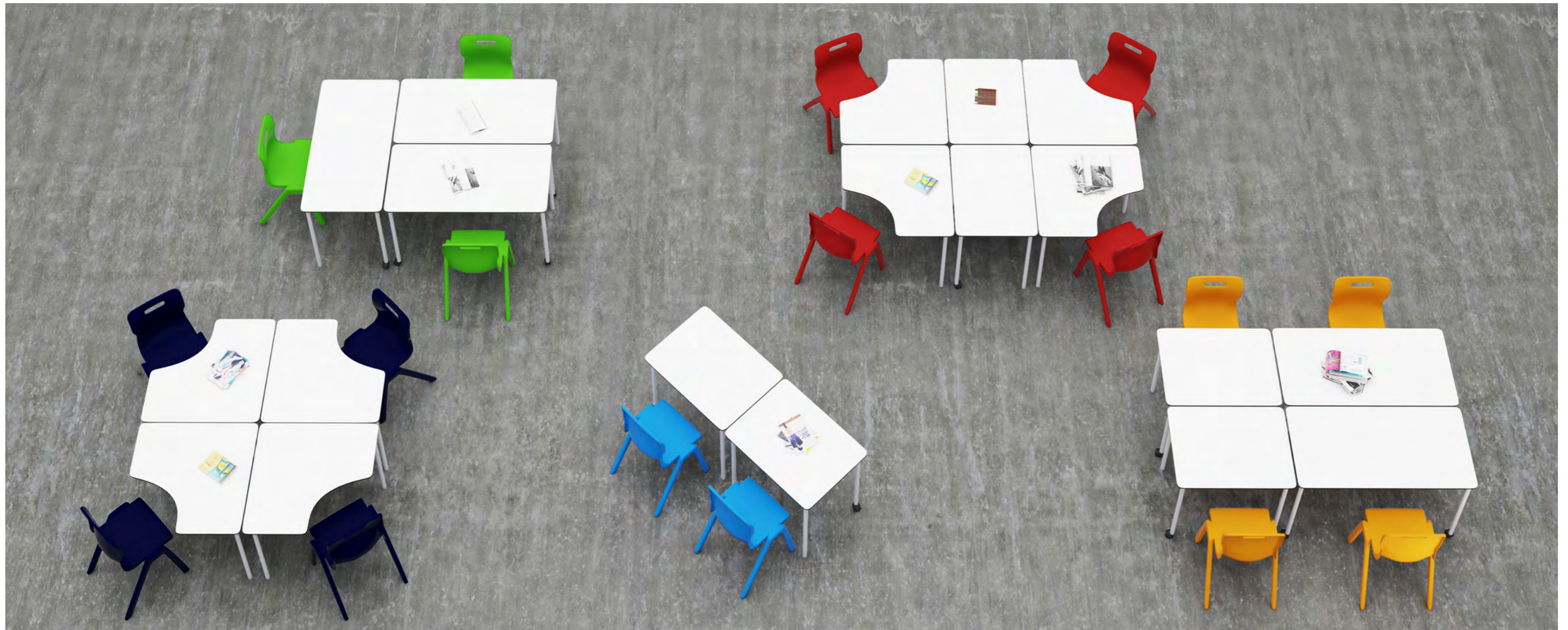

KD CLASSROOM TABLES

5 YR
COMPONENT
GUARANTEE

25 MM
TOP
THICKNESS



760 PU EDGE RECTANGULAR TABLE

T-TABLE-1276	Overall Dimensions
	D600 W1200 H760

760 PU EDGE SQUARE TABLE

T-TABLE-6076	Overall Dimensions
	D600 W600 H760

710 PU EDGE RECTANGULAR TABLE

T-TABLE-1271	Overall Dimensions
	D600 W1200 H710

710 PU EDGE SQUARE TABLE

T-TABLE-6071	Overall Dimensions
	D600 W600 H710

TOP FINISHES // FRAME FINISH



- KD design
- Metal to metal fixings for strength
- PU moulded edge



KD CLASSROOM TABLES

A great selection of multi-purpose PU edged school tables that come in a range of heights & widths, making them suitable for both primary, secondary and further educational spaces.

Supplied KD or through our D&I service these offer a cost-effective solution to creating collaborative spaces.



EXAM DESKS & FOLDING TABLES

- CLASSROOM SAFE
- STABLE BASE
- EASY CLEAN
- ULTRA STRONG
- 2YR GUARANTEE



EXAM DESK

	Overall Dimensions
T10	D600 W600 H710

Graffiti proof wipe clean injection moulded polypropylene top with pen groove with ultra-strong 22mm diameter Black EPC folding frame



MDF EXAM DESK

	Overall Dimensions
TC66ED-PREM-720	D600 W600 H720
TC66ED-ECON-720-NS	D600 W600 H720

18mm thick Beech laminate MDF with pen groove, 22mm diameter Black EPC frame with integral safety bar to assist safer folding and storage



EXAM DESK TROLLEY

	Overall Dimensions
TCEDT-20T	D1225 W660 H1150

Capacity: 20 exam desks



EXAM DESK TROLLEY

	Overall Dimensions
T10-T	D1267 W600 H473

Capacity: 40 exam desks

2YR GUARANTEE



LIGHTWEIGHT FOLDING TABLE

	Overall Dimensions
OF0411	D685 W1220 H698
OF0412	D685 W1520 H698
OF0413	D685 W1830 H698

- Lightweight, strong and durable
- Can be used individually or together to form various configurations
- Wipe clean





IT CLASSROOM CHAIRS

2 YR COMPONENT GUARANTEE 2 YR UPHOLSTERY GUARANTEE 110 KG WEIGHT TOLERANCE 5 H HOURS USAGE



MID BACK

	Seat Dimensions	Back Dimensions
CH0709	D445 W460 H490 - 620	D435 H410

FR: Med
Fabric: 100% Man-made
Mechanism: Fixed back



HIGH BACK

	Seat Dimensions	Back Dimensions
CH0707	D445 W460 H490 - 620	D435 H500

FR: Med
Fabric: 100% Man-made
Mechanism: Fixed back



ANTI TAMPER

	Seat Dimensions	Back Dimensions
CH0702	D445 W460 H490 - 620	D435 H410

FR: Med
Fabric: 100% Man-made
Mechanism: Fixed back



VISITOR

	Seat Dimensions	Back Dimensions
CH0710	D440 W455 H490	D435 H420

FR: Med
Fabric: 100% Man-made



LAB CHAIRS



ZOOM MB FIXED D-KIT

	Seat Dimensions	Back Dimensions
CH0709 + AC1014	D445 W460 H730 - 870	D435 H410

FR: Med
Fabric: 100% Man-made
Mechanism: Fixed back
Guarantee: 2yr

Weight capacity: 110kg
Usage: 5hr



ZOOM MB ADJUSTABLE D-KIT

	Seat Dimensions	Back Dimensions
CH0709 + AC1042	D445 W460 H610 - 865	D435 H410

FR: Med
Fabric: 100% Man-made
Mechanism: Fixed back
Guarantee: 2yr

Weight capacity: 110kg
Usage: 5hr



CONCEPT MB FIXED D-KIT

	Seat Dimensions	Back Dimensions
CH0803 + AC1014	D475 W470 H705 - 835	D420 H400

FR: Med
Fabric: 100% Man-made
Mechanism: PCB
Guarantee: 5yr

Weight capacity: 115kg
Usage: 8hr



CONCEPT MB ADJUSTABLE D-KIT

	Seat Dimensions	Back Dimensions
CH0803 + AC1042	D475 W470 H585 - 830	D420 H400

FR: Med
Fabric: 100% Man-made
Mechanism: PCB
Guarantee: 5yr

Weight capacity: 115kg
Usage: 8hr





TEACHER FURNITURE

2YR COMPONENT GUARANTEE
2YR UPHOLSTERY GUARANTEE
115KG WEIGHT TOLERANCE
8H HOURS USAGE



SINGLE LEVER

	Seat Dimensions	Back Dimensions
CH2804	D440 W460 H485 - 615	W450 H490

FR: Med
 Fabric: 100%
 Man-made
 Mechanism: Fixed

PU FINISH // FABRIC FINISHES



HIGH BACK

	Seat Dimensions	Back Dimensions
CH2800	D470 W470 H470 - 600	W450 H500

FR: Med
 Fabric: 100%
 Man-made
 Mechanism: PCB

PU FINISH // FABRIC FINISHES



5YR COMPONENT GUARANTEE
18MM TOP THICKNESS



SINGLE DESK & 3 DRAWER PEDESTAL

	Dimensions			RRP
	W	D	H	
EF1275REC3DP	1200	750	730	£252.00
EF1575REC3DP	1500	750	730	£282.00
EF1875REC3DP	1800	750	730	£282.00

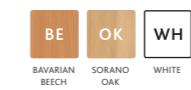

SINGLE DESK & 5 DRAWER PEDESTALS

	Dimensions			RRP
	W	D	H	
EF1575REC5DP	1500	750	730	£352.00
EF1875REC5DP	1800	750	730	£382.00



STAFFROOM

5^{YR} COMPONENT GUARANTEE 2^{YR} UPHOLSTERY GUARANTEE 115^{KG} WEIGHT TOLERANCE 8^H HOURS USAGE



GLACIER

	Seat Dimensions	Back Dimensions
OF0601	D470 W610 H410	W610 H420

GLACIER ARM

	Dimensions
OF0602 (sold as singles)	D650 W100 H600

FR: Med
Fabric: 100% Man-made



FR: Med
Fabric: 100% Man-made



GLACIER TABLE

	Dimensions
OF0603	D620 W620 H370

FR: Med
Fabric: 100% Man-made



RUBIC

	Seat Dimensions	Back Dimensions
OF0307	D550 W530 H430	W530 H390

FR: Med
Fabric: 100% Man-made



DINING HALL TABLES

5^{YR} COMPONENT GUARANTEE 18^{MM} TOP THICKNESS



RECTANGULAR

	Dimensions			RRP
	W	D	H	
OMPT1280REC	1200	800	730	£134.00
OMPT1680REC	1600	800	730	£144.00
OMPT1880REC	1800	800	730	£150.00



TRAPEZOIDAL

	Dimensions			RRP
	W	D	H	
OMPT1680TRAP	1600	692	730	£254.00



SEMI-CIRCULAR

	Dimensions			RRP
	W	D	H	
OMPT1680SEMI	1600	800	730	£254.00





TITAN ACCESSORIES

1 YR
GUARANTEE

SEATPAD EXPLANATION:

The Titan padded seat pad is the perfect addition to Titan chairs ranging from size three to size five. Available in unlimited fabric, these seat pads are upholstered in the UK to a colour and texture of your choosing to make learning a little bit more comfortable.



FABRIC SEAT PAD

	Overall Dimensions
T8	D345 W365

Upholstered in Camira Phoenix fabric
Minimum order quantity of 5



CAMIRA PHEONIX OPTIONS

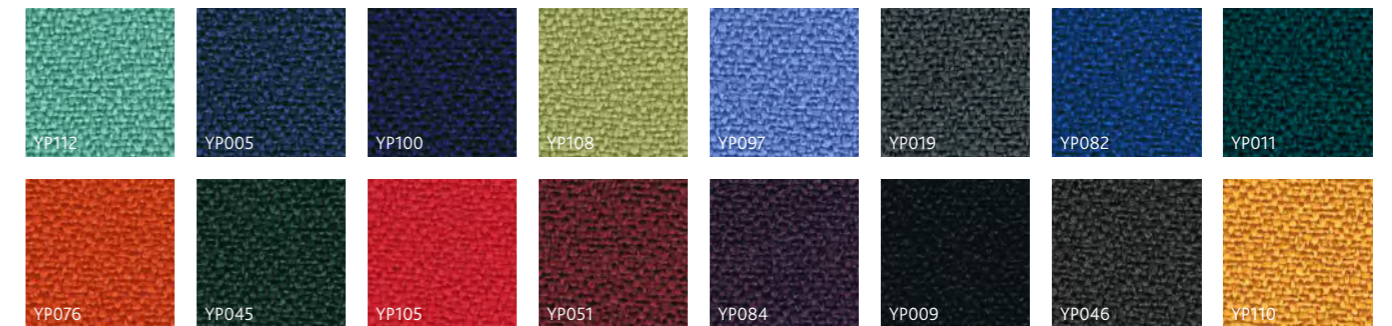

TROLLEY

	Overall Dimensions
T40	D480 W650 H1158

Capacity: 15 chairs



EXAM DESK TROLLEY

	Overall Dimensions
TCEDT-20T	D1225 W660 H1150

Capacity: 20 exam desks



EXAM DESK TROLLEY

	Overall Dimensions
T10-T	D1267 W600 H473

Capacity: 40 exam desks



FABRIC BAND GUIDE



Where you see the adjacent icon, the product is available upholstered to your exact specification. Choose multiple on-trend finishes to match your market place or corporate colour scheme, or simply something different to brighten up your business environment.

MANUFACTURER	MATERIAL NAME	1	2	3	4	5	6	LEATHER	WOOL CONTENT %AGE	CRIB FIRE RATING	APPLICATION
Chieftain	Trimcell Classic		•						0	LOW HAZARD	TASK & SS
Chieftain	Trimcell Legend			•					0	LOW HAZARD	TASK & SS
Chieftain	Carino			•					0	CRIB 5	TASK & SS
Chieftain	Just Colour			•					0	CRIB 7	TASK & SS
Chieftain	Just Patterns			•					0	CRIB 5	TASK & SS
Chieftain	Lionella				•				0	CRIB 5	TASK & SS
Chieftain	Casco				•				0	CRIB 5	TASK & SS
Chieftain	Cube				•				0	CRIB 5	TASK & SS
Chieftain	Marquis				•				0	CRIB 5	TASK & SS
Chieftain	Riviera				•				0	CRIB 5	TASK & SS
Chieftain	Self Colour				•				0	CRIB 5	TASK & SS
Chieftain	Traditional				•				0	CRIB 5	TASK & SS
Chieftain	Universal				•				0	CRIB 5	TASK & SS
Chieftain	Multistretch					•			0	CRIB 5	TASK & SS
Agua	Libra	•							0	CRIB 5	TASK & SS
Agua	Paint Pot		•						0	CRIB 5	TASK & SS
Agua	Taurus collection			•					0	CRIB 5	TASK & SS
Agua	Parody			•					0	CRIB 5	TASK & SS
Agua	Nova			•					0	CRIB 5	TASK & SS
Agua	Cashmir			•					0	CRIB 5	TASK & SS
Agua	Funisoft PU				•				0	CRIB 5	TASK & SS
Camira	Cara	•							0	LOW HAZARD	SCREENS
Camira	Phoenix	•							0	LOW HAZARD	TASK
Camira	Citadel	•							0	LOW HAZARD	TASK
Camira	Rivet	•							0	LOW HAZARD	TASK & SS
Camira	Era	•							0	LOW HAZARD	TASK & SS
Camira	Advantage	•							30	LOW HAZARD	TASK
Camira	Gravity	•							0	CRIB 5	TASK & SS
Camira	Lucia	•							0	LOW HAZARD	SCREENS
Camira	Sonus	•							0	BS 476 PT.7 C.1	SCREENS
Camira	Manhattan	•							0	LOW HAZARD	TASK
Camira	Racer	•							0	BS 476 PT.7 C.1	SCREENS
Camira	L2	•							0	BS 476 PT.7 C.1	SCREENS
Camira	Xtreme			•					0	CRIB 5	TASK
Camira	Canopy		•						0	LOW HAZARD	TASK & SS
Camira	Sprint		•						0	LOW HAZARD	TASK & SS
Camira	Chateau		•						0	LOW HAZARD	TASK
Camira	Velocity			•					0	LOW HAZARD	TASK & SS
Camira	Vita			•					0	CRIB 5	TASK & SS
Camira	Urban			•					0	CRIB 5	TASK
Camira	X2			•					0	CRIB 5	TASK & SS
Camira	Main Line Plus			•					67	CRIB 5	TASK & SS
Camira	Aspect			•					0	CRIB 5	TASK & SS
Camira	Main Line Flax				•				70	CRIB 5	TASK & SS
Camira	Halcyon - Linden				•				0	CRIB 5	TASK & SS
Camira	Honeycomb				•				0	CRIB 5	TASK & SS
Camira	Nexus				•				0	LOW HAZARD	SCREENS
Camira	Blazer Lite				•				100	BS 476 PT.7 C.1	SCREENS
Camira	Halcyon - Cedar					•			0	CRIB 5	TASK & SS
Camira	Halcyon - Poplar					•			0	CRIB 5	TASK & SS
Camira	Halcyon - Aspen					•			0	CRIB 5	TASK & SS
Camira	Halcyon - Blossom					•			0	CRIB 5	TASK & SS
Camira	Hi-Tech					•			29	LOW HAZARD	TASK & SS

Featured swatches in following fabric brand pages

* WHEN TREATED

PLEASE NOTE:
 FABRIC BANDINGS - Should your fabric of choice not be listed please contact our sales teams who will be happy to assist. The above is intended as a guide only. Please ensure you check the suitability of your selected fabric for its application prior to ordering.
 LEATHER - All leather fabrics are priced on application.
 FABRIC SWATCHES - We recommend that your final fabric selection is made based on a physical swatch only. Please note colour accuracy of printed fabric swatches is not guaranteed and is intended as a guide only.

MANUFACTURER	MATERIAL NAME	1	2	3	4	5	6	LEATHER	WOOL CONTENT %AGE	CRIB FIRE RATING	APPLICATION
Camira	Synergy					•			95	CRIB 5*	TASK & SS
Camira	Hemp					•			60	CRIB 5	TASK & SS
Camira	24/7 +					•			33	CRIB 5	TASK & SS
Camira	24/7 Flax					•			30	CRIB 5	TASK
Camira	Landscape Balance/Contact					•			95	CRIB 5*	TASK & SS
Camira	Intervene Plain/Texture					•			0	CRIB 5	TASK & SS
Camira	Blazer					•			100	CRIB 5*	TASK & SS
Camira	Marvel					•			0	CRIB 5	TASK & SS
Camira	Aquarius					•			100	CRIB 5*	TASK & SS
Camira	Oxygen					•			90	CRIB 5*	TASK
Camira	Silk					•			67	CRIB 5	TASK & SS
Camira	Track					•			0	CRIB 5	TASK & SS
Camira	Synergy 170					•			95	LOW HAZARD	SCREEN
Camira	Hebden					•			60	CRIB 5	TASK & SS
Camira	Main Line Flax Stripe					•			70	CRIB 5	TASK & SS
Camira	Trail					•			0	CRIB 5	TASK & SS
Camira	Individuo						•		95	CRIB 5*	TASK & SS
Camira	Stripes						•		95	CRIB 5	TASK & SS
Camira	Craggan						•		100	CRIB 5	TASK & SS
Camira	Code						•		85	CRIB 5*	TASK & SS
Camira	Century						•		77	CRIB 5	TASK & SS
CrestJTM	Contempo							•	0	CRIB 5	TASK & SS
CrestJTM	Shelly							•	0	CRIB 5	TASK & SS
CrestJTM	Vele							•	0	CRIB 5	TASK & SS
CrestJTM	Cambridge							•	0	CRIB 5	TASK & SS
CrestJTM	Colorado							•	0	CRIB 5	TASK & SS
Yarwood	Dollaro (vinyl)			•					0	CRIB 5	TASK & SS
Yarwood	Aneurin (vinyl)				•				0	CRIB 5	TASK & SS
Yarwood	Ascot (vinyl)				•				0	CRIB 5	TASK & SS
Yarwood	Churchill (vinyl)					•			0	CRIB 5	TASK & SS
Yarwood	Camden							•	0	CRIB 5	TASK & SS
Yarwood	Style							•	0	CRIB 5	TASK & SS
Yarwood	Hammersmith							•	0	CRIB 5	TASK & SS
Yarwood	Capri							•	0	CRIB 5	TASK & SS
Yarwood	Mustang							•	0	CRIB 5	TASK & SS

Featured swatches in following fabric brand pages

* WHEN TREATED

PLEASE NOTE:
 FABRIC BANDINGS - Should your fabric of choice not be listed please contact our sales teams who will be happy to assist. The above is intended as a guide only. Please ensure you check the suitability of your selected fabric for its application prior to ordering.
 LEATHER - All leather fabrics are priced on application.
 FABRIC SWATCHES - We recommend that your final fabric selection is made based on a physical swatch only. Please note colour accuracy of printed fabric swatches is not guaranteed and is intended as a guide only.



Chieftain Fabrics are experts in vinyl upholstery. It is their only focus and they believe that for this reason, they are the best at what they do. Chieftain specialise in the design and production of high quality performance fabric and contract upholstery, and have done for over 60 years. With their unique mix of specialist expertise, innovative R&D and advanced materials, they produce an inherently better fabric.

Chieftain are constantly striving to keep up with ever changing technologies and have the only fabric that has passed both the Tropical test and Crib 7.



FABRIC BAND 3



Application
High traffic areas, stadia seating, restaurant, hotel, healthcare, prisons, high security environments etc.

Characteristics
Surface : Phthalate free PVC
Backing : Cotton/PES
Weight : 705 g/m2
Thickness : 1.10mm
Bursting Strength : 1,200+kPa
Abrasion : 500,000+ Martindale Rubs

Flame Retardancy
BS5852 Ignition Source 7 - Crib 7 as standard
BS7176 Medium Hazard
S.I. 1988 No.1324 Schedule 4 and 5
BS EN1021-1 and 2
CS-25
FMVSS 302
IMO A 652 (16)
M2
B2

Jungle / Tropical Test
ISO 1419 : 1995 Accelerated Aging Test

Antimicrobial
ISO 22196
G21
Independent testing has verified that Just Colour is effective at reducing the spread of MRSA, E.Coli, and other similar bacteria.

See Chieftainfabrics.com for further details and cleaning instructions.



FABRIC BAND 3



Application
Domestic application only - not suitable for contract use.

Characteristics
Surface : PVC
Backing : PES or Cotton PES
Weight : 608g/m2
Thickness : 1.00mm
Bursting Strength : 1,000+kPa
Abrasion : 40,000+ Martindale Rubs

Flame Retardancy
BS7176 Low Hazard
S.I. 1988 No.1324 Schedule 4 and 5
BS EN1021-1 and 2
CS-25
FMVSS 302
IMO A 652 (16)

See Chieftainfabrics.com for further details and cleaning instructions.

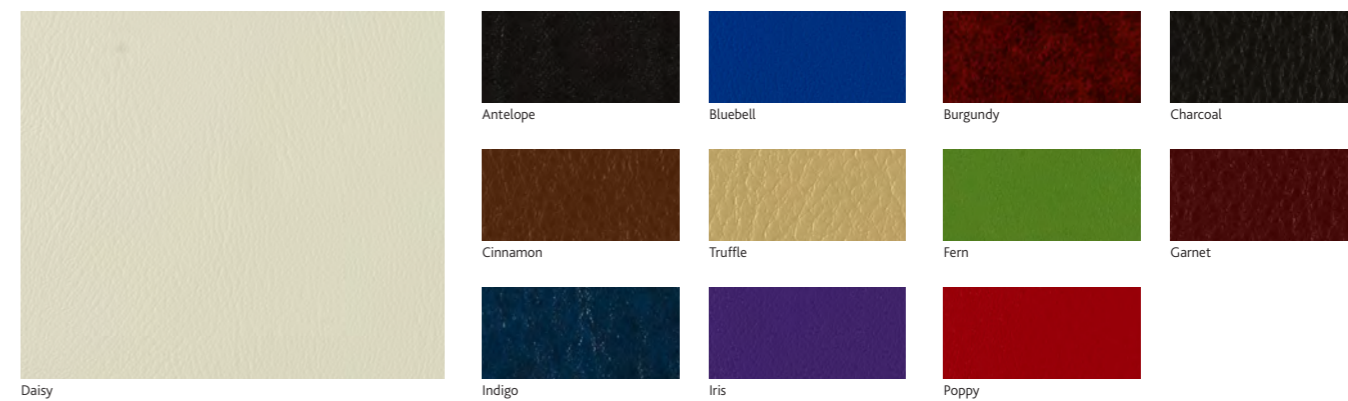

FABRIC BAND 4



Application
High traffic areas, stadia seating, restaurant, hotel, healthcare etc.

Characteristics
Surface : Phthalate free PVC 85% : 15% PU
Backing : 100% Organic Cotton
Weight : 800g/m2
Thickness : 1.25mm
Bursting Strength : 1,000+kPa
Abrasion : 500,000+ Martindale Rubs

Flame Retardancy
BS5852 Ignition Source 5 - Crib 5 as standard
BS7176 Medium Hazard
S.I. 1988 No.1324 Schedule 4 and 5
BS EN1021-1 and 2
CS-25
FMVSS 302
IMO A 652 (16)

Antimicrobial
ISO 22196
Independent testing has verified that Lionella is effective at reducing the spread of MRSA, E.Coli, and other similar bacteria.

See Chieftainfabrics.com for further details and cleaning instructions.



FABRIC BAND 3



Application
High traffic areas, stadia seating, restaurant, hotel, healthcare etc.

Characteristics
Surface : Phthalate free PVC
Backing : Cotton/PES
Weight : 705 g/m2
Thickness : 1.10mm
Bursting Strength : 1,200+kPa
Abrasion : 500,000+ Martindale Rubs

Flame Retardancy
BS5852 Ignition Source 5 - Crib 5 as standard
BS7176 Medium Hazard
S.I. 1988 No.1324 Schedule 4 and 5
BS EN1021-1 and 2
CS-25
FMVSS 302
IMO A 652 (16)

Antimicrobial
ISO 22196
Independent testing has verified that Carino is effective at reducing the spread of MRSA, E.Coli, and other similar bacteria.

See Chieftainfabrics.com for further details and cleaning instructions.



camira

Camira have been weaving the fabric of the world for decades. They produce fabrics for spaces and places, from offices to schools, trains to buses, and shops to hospitals. Camira manufacture over 8 million metres of fabric a year so you're sure to have touched upon their fabrics either at work, at play or on the move. From their manufacturing plant, registered to ISO 9001 and 14001 standards, they make 8 million metres of fabric a year meeting international flammability regulations, celebrating colour, design, technical and environmental innovation.

CAMIRA MAIN LINE FLAX - FABRIC BAND 4

Composition
70% Virgin Wool, 30% Flax

Environmental
Rapidly renewable and compostable.

Abrasion Resistance
Heavy duty / 10 year guarantee
Independently certified to ≥50,000
Martindale cycles

Flammability
EN 1021 - 1 (cigarette)
EN 1021 - 2 (match)
BS 7176 Low Hazard
BS 5852 Ignition Source 5
BS 7176 Medium Hazard
BS 5867-2 Type B Curtains & Drapes
UNI 9175 Classe 1 IM
ÖNORM B 3825 & A 3800-1

Light Fastness
5 (ISO 105 - B02)

Fastness to Rubbing
Wet: 3, Dry: 4 (ISO 105 - x12)

Note: Flammability performance is dependent on components used.

See Camirafabrics.com for further details and cleaning instructions.

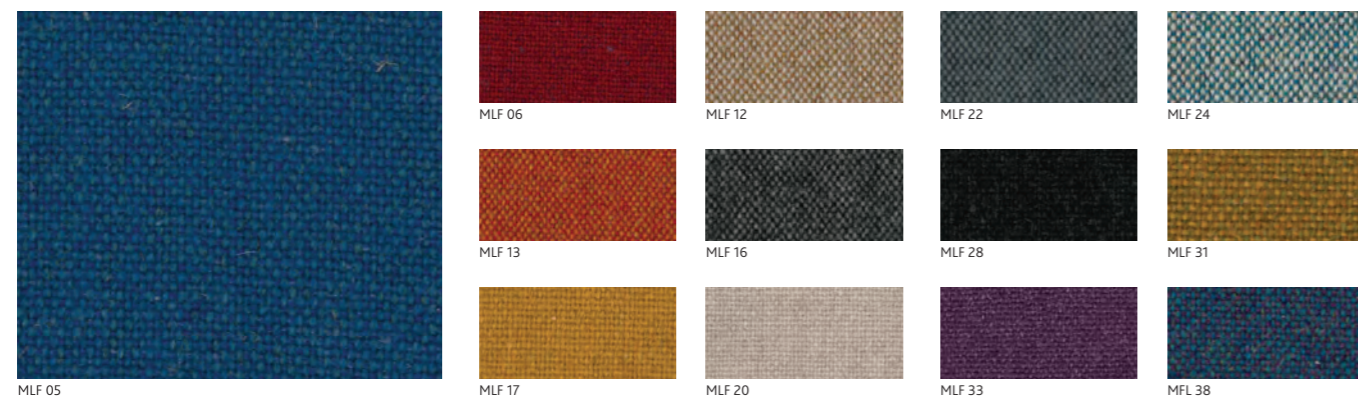

CAMIRA SYNERGY - FABRIC BAND 5

Composition
95% Virgin Wool, 5% Polyamide.
Non metallic dyestuffs

Weight
400g/m2 ±5% (560g/lin.m ±5%)

Abrasion Resistance
Heavy duty / 10 year guarantee
Independently certified to ≥100,000
Martindale cycles

Flammability
EN 1021 - 1 (cigarette)
EN 1021 - 2 (match)
BS 7176 Low Hazard
UNI 9175 Classe 1 IM
NF D 60-013
ÖNORM B 3825 & A 3800-1
Optional: Please specify when ordering: BS 5852 Ignition Source 5 when FR treated
BS 7176 Medium Hazard when FR

Light Fastness
5 (ISO 105 - B02)

Fastness to Rubbing
Wet:4 Dry:4 (ISO 105 - X12)
Cleaning
Vacuum regularly. Professionally dry clean or wipe clean with a damp cloth.

Note: Flammability performance is dependent on components used

See Camirafabrics.com for further details and cleaning instructions

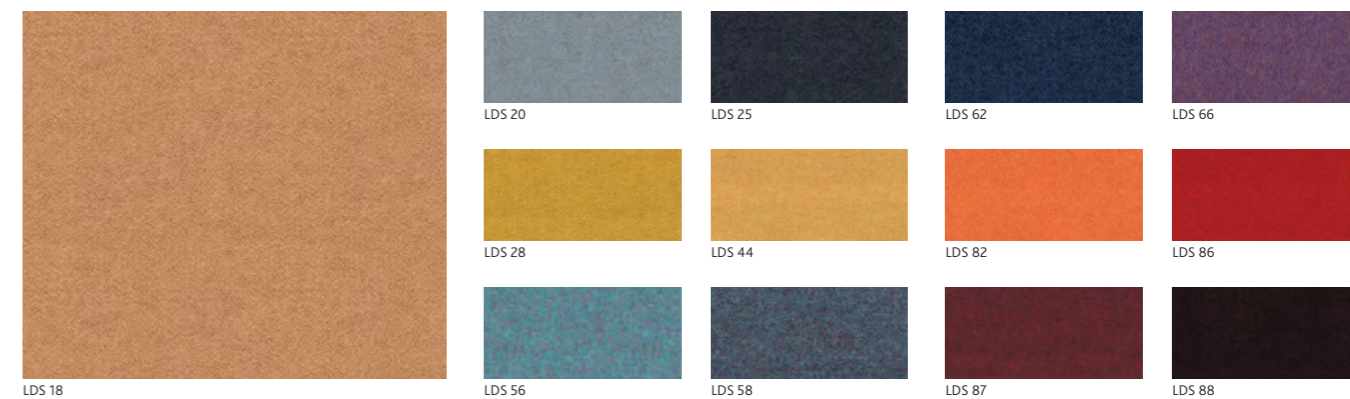

CAMIRA RIVET - FABRIC BAND 1

Composition
100% Repreve Recycled Polyester.
REPREVE® Unifi, Inc.

Environmental
Made from 100% post-consumer recycled polyester.

Weight
280g/m2 ±5% (390g/lin.m +/-5%)

Abrasion Resistance
Heavy duty / 10 year guarantee
Independently certified to ≥80,000
Martindale cycles

Flammability
EN 1021 - 1 (cigarette)
EN 1021 - 2 (match)
BS 7176 Low Hazard

Light Fastness
6 (ISO 105 - B02)

Fastness to Rubbing
Wet: 4, Dry: 4 (ISO 105 - X12)

Note: Flammability performance is dependent on components used.

See Camirafabrics.com for further details and cleaning instructions.



CAMIRA XTREME - FABRIC BAND 3

Composition
100% Recycled Flame Retardant Polyester
Non metallic dyestuffs

Environmental
Made from 100% recycled polyester
Certified to the EU Ecolabel

Weight
310g/m2 ±5% (435g/lin.m ±5%)

Abrasion Resistance
Heavy duty / 10 year guarantee
Independently certified to ≥100,00
Martindale cycles

Flammability
EN 1021 - 1 (cigarette)
EN 1021 - 2 (match)
BS 7176 Low Hazard
BS 5852 Ignition Source 5
BS 7176 Medium Hazard
DIN 4102 B1

UNI 8456 & UNI 9174 Classe 1
NF D 60-013

Note: Flammability performance is dependent on components used.

Light Fastness
6 (ISO 105 - B02)

Fastness to Rubbing
Wet:4, Dry:4 (ISO 105 - x12)
See Camirafabrics.com for further details and cleaning instructions.

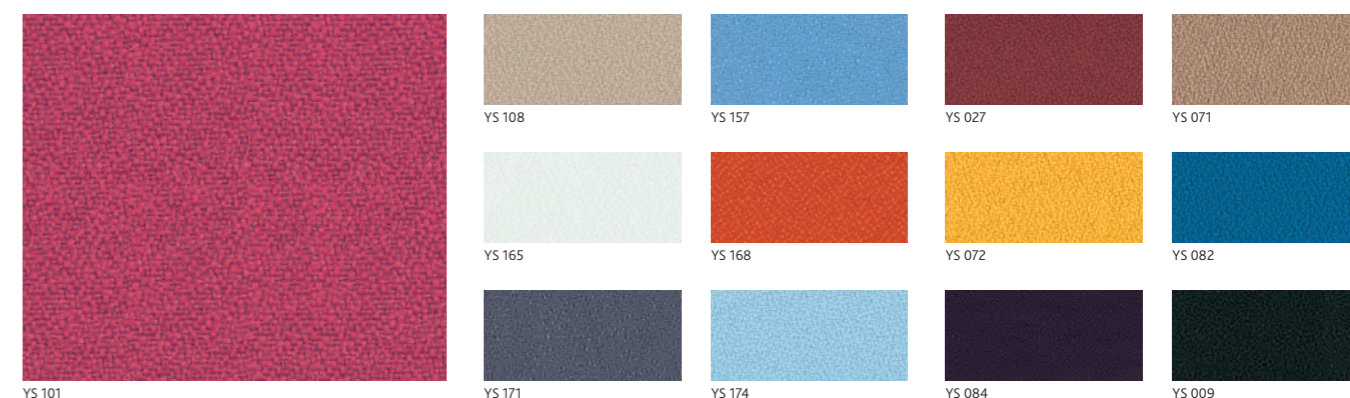

FINISHES & COLOURS

Our finishes are designed for ease of coordination and use, abundance of choice and thoughtfulness to the environment. The offering consists of a wide selection of textiles, paints, decors, veneer finishes, glass, acrylic, metals, and plastics.

On these pages we have listed some of our most popular MFC and Steel finishes to assist you in choosing the right finishes for your project.

STOCKED MFC COLOUR RANGES

Ranges

Height Adjustable Desking, Bench Desking, Desking, Meeting Tables & Wooden Storage

Care & Maintenance

Due to its resistant, hygienic and dense surface, these Laminates do not require any special form of care. The surface is generally easy to clean. Do not use sanitary cleaners or detergents with abrasive components, as such cleaners may lead to changes in the gloss level and/or scratching of the material.



LEG FINISHES



PROJECT RANGE MFC FINISHES

Ranges

Project, Storage & Meeting Tables

Care & Maintenance

Due to its resistant, hygienic and dense surface, these Laminates do not require any special form of care. The surface is generally easy to clean. Do not use sanitary cleaners or detergents with abrasive components, as such cleaners may lead to changes in the gloss level and/or scratching of the material.

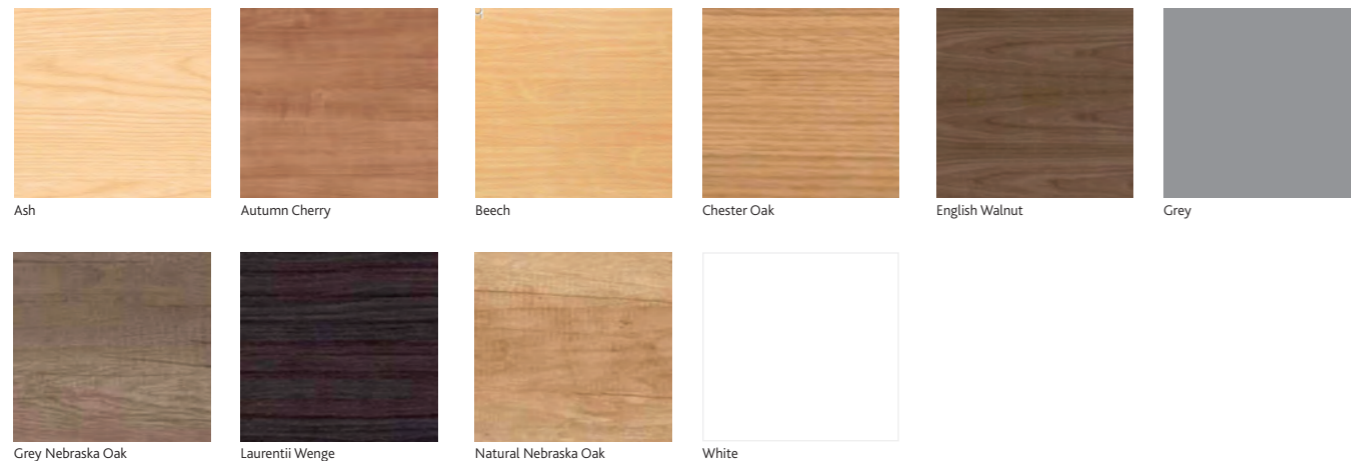

LEG FINISHES



PICNIC AND PLATEAU MEETING TABLE FINISHES

Ranges

Picnic & Plateau

Care & Maintenance

Due to its resistant, hygienic and dense surface, these Laminates do not require any special form of care. The surface is generally easy to clean. Do not use sanitary cleaners or detergents with abrasive components, as such cleaners may lead to changes in the gloss level and/or scratching of the material.

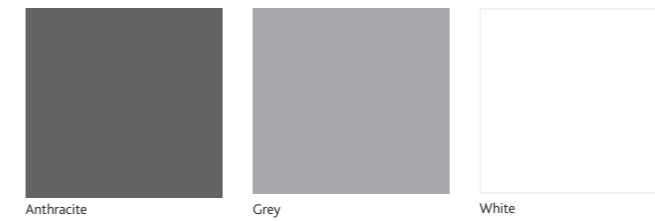

LEG FINISHES



TALOS STEEL COLOURS

Ranges

Talos

Care & Maintenance

Carefully remove any loose surface deposits with a wet sponge. Use a soft brush (non abrasive) and a dilute solution of a mild detergent, eg, pH-neutral liquid hand dishwashing detergent in warm water (DO NOT use solvents) to remove dust, salt and other deposits.



BISLEY STEEL COLOURS

Ranges

Bisley Steel Storage

Care & Maintenance

Carefully remove any loose surface deposits with a wet sponge. Use a soft brush (non abrasive) and a dilute solution of a mild detergent, eg, pH-neutral liquid hand dishwashing detergent in warm water (DO NOT use solvents) to remove dust, salt and other deposits.

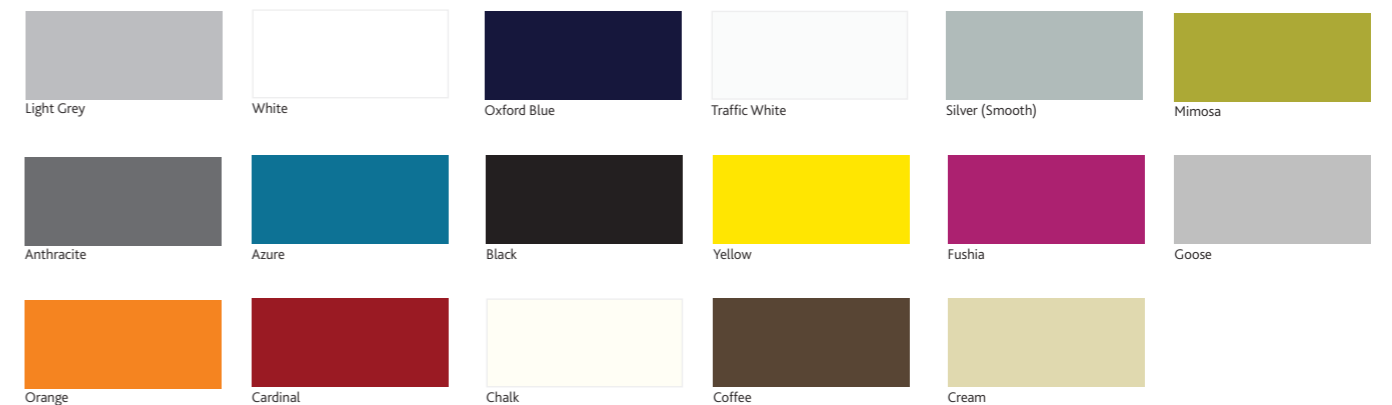

1300 Aztec West, Park Avenue, Aztec West,
Bristol, BS32 4RX, United Kingdom

t : +44 (0) 1454 207360
f : +44 (0) 1454 207367
e : info@tcoffice.co.uk
w : www.tcoffice.co.uk

