



OPERATING MANUAL

CHANNEL BALING PRESS

SP 5080

Keep this instruction for future use!

CE **HSM**[®]

HSM GmbH + Co.KG,
Austrasse 1-9,
88699 Frickingen / Germany
Tel. + 49 75 54 2100-0
Fax + 49 75 54 2100-160
info@hsm.eu
www.hsm.eu

Contents

	Nameplate	6
	Foreword	7
1	Safety	8
1.1	Notes on safety.....	8
1.1.1	"Work safety" symbol.....	8
1.1.2	"Notice" symbol.....	8
1.2	Classification of hazards.....	8
1.2.1	Danger.....	8
1.2.2	Warning.....	8
1.2.3	Caution.....	8
1.3	Notes on work safety.....	9
1.4	Proper use.....	11
1.5	Inspecting the safety devices.....	12
2	Technical data	15
2.1	Power requirement and fuse rate.....	15
2.2	KP 80 Combined press.....	15
2.3	FA 500.3 Shredder.....	16
2.4	Operating conditions.....	16
2.5	Accessories.....	16
2.6	SP 5080 explanatory diagram.....	17
2.7	Machine dimensions.....	18
3	Preparations	19
3.1	General instructions.....	19
3.2	Siting the machine.....	19
3.3	Supply connections.....	19
3.4	Settings.....	19
3.5	Transporting the baling press.....	20
3.5.1	Transport to another application site.....	20
3.6	Transporting the shredder.....	21
3.7	Assembling the shredder.....	22
3.8	Assembling the shredder press combination.....	23

4	Commissioning	26
4.1	Baling press controls	26
4.1.1	Accessing the SERVICE menu.....	30
4.1.2	Set-up mode	31
4.1.2.1	Pressure plate forward-backward / door lock open-close	31
4.1.2.2	To exit set-up mode.....	31
4.1.3	To display / clear the daily bale meter.....	32
4.1.4	To display the total bale meter	32
4.1.5	To display the service hours meter	32
4.1.6	To set the user language.....	33
4.1.7	To display the error memory	33
4.1.8	System.....	33
4.2	Shredder control panel	34
4.2.1	Display: Baling press not in automatic mode.....	34
4.2.2	Display: Status of the baling press.....	34
4.3	Initial start-up	35
4.4	Using the machine.....	36
4.4.1	Fit the plastic bag and start the machine	36
4.5	Ejecting and bagging the bale	40
4.6	Malfunctions of the baling press	43
4.6.1	Error numbers	43
4.7	Malfunctions of the shredder	44
4.7.1	Overload due to paper jam	44
4.7.2	Electric motor overheats	44
4.7.3	Emergency stop activated.....	44
4.7.4	Oil reservoir empty.....	45
4.8	Stopping the machine.....	45
4.9	Outdoor use.....	45
5	Inspection and maintenance work	46
5.1	Notes on maintenance.....	46
5.2	Maintenance of the combined press.....	47
5.2.1	Changing the hydraulic fluid / venting filter	47
5.2.2	Lubricating the movable parts.....	48
5.3	Maintenance of the FA 500.3 shredder	49
5.3.1	Lubricating the drive chains and synchronized wheels (2 x per year)	49
5.3.2	Retighten the feed belt.....	50
5.3.3	Check the directional stability of the feed belt	50
5.3.4	Check the feed belt for wear	50
5.3.5	Emptying the collecting tray.....	51

6	Storage	52
7	Disposal instructions	52
	7.1 Disposal verification form	53
8	Using and ordering spare parts	54
	8.1 Customer service address.....	54
9	Electrical circuit diagrams	55
10	KP 80 hydraulic diagram	56
11	EC declaration of conformity	57

Nameplate

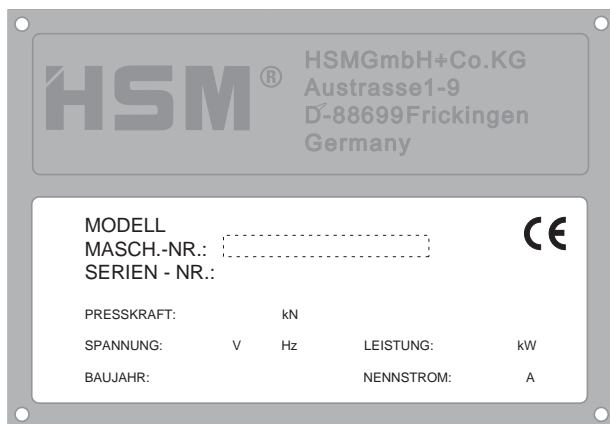

The machine number is specified on the nameplate of the baling press, shown above. Guarantee claims and inquiries cannot be processed if you do not quote the machine number.

Please therefore enter this number into the grey field of the nameplate immediately after receipt of the baling press.

Foreword

This Operating Manual informs you in detail about the start-up and maintenance of your new baling press. It also contains notes on safety which must be observed.

To a great extent, the performance of your baling press depends on its proper application and thorough maintenance. You should carefully read this Operating Manual and the notes on safety and always keep them safe at hand. You can thus prevent accidents, maintain your guarantee claims against the manufacturer and always have an operative baling press.

HSM GmbH + Co. KG permanently aspire to improve their products. They reserve the right to perform any changes and modifications which are deemed necessary. However, this does not imply the obligation for a subsequent modification of already delivered machines.

Technical modifications as compared to the representations and statements in this Operating Manual which become necessary to improve the baling press are reserved.

This Operating Manual is intended for staff installing, operating and servicing the baling press. It includes technical specifications and drawings which must not be copied, distributed or used for competitive purposes or given to third parties completely or in part.

Please contact your local dealer if you still have questions after having read this Operating Manual.

1 Safety

1.1 Notes on safety

1.1.1 "Work safety" symbol



This symbol marks all work safety notes in this Operating Manual which endanger the health or life of people. Please pay attention to this symbol and exercise particular care in such cases. Please also forward all work safety notes to other users.

Apart from the instructions in this manual, you must also follow generally applicable safety and accident prevention regulations..

1.1.2 "Notice" symbol



This symbol marks information in this manual which requires particular attention so that guidelines, regulations, instructions and correct working procedures are followed and damage to or ruin of the machine and/or other equipment prevented.

1.2 Classification of hazards

1.2.1 Danger



identifies an immediate danger. If not avoided, it will result in death or severe injuries (crippling).

1.2.2 Warning



identifies a possibly dangerous situation. If not avoided, it could result in death or severe injuries.

1.2.3 Caution



identifies a possibly dangerous situation. If not avoided, it could result in light or minor injuries. Is also used for warnings concerning damage to material.

1.3 Notes on work safety

Please pay particular attention to the following notes on work safety:

– The SP 5080 shredder press combination has been safety-tested by an accredited testing station.

Nevertheless, incorrect operation and misuse can result in:

- the health or life of the operator
 - the machine and other valuable equipment
 - the efficient operation of the shredder
- The SP 5080 shredder press combination has been built with the most up-to-date technology. However, the machine can be dangerous if improperly used, even by trained staff, or if used for purposes other than those for which it was designed.
- The operation of the shredder press combination is always subject to local safety and accident prevention regulations.
- The employer must observe and comply with the “minimum safety and health requirements for the use of work equipment by workers at work”. Machinery Directive 2009/104/EC
- The shredder press combination may not be operated by anyone under 16 years of age.
- All those charged with installation, assembly, disassembly, start-up, operation, inspection, maintenance or repair of the baling press must have first read and fully understood the entire operating manual, paying particular attention to the “Safety” section.
- The shredder press combination may only be operated, serviced and repaired by authorised, trained staff. These staff must have been given special instructions on any dangers which may possibly arise.
- Areas of personal responsibility for installation, assembly, re-assembly, set-up, operation and maintenance must be clearly defined and strictly adhered to, in order to avoid confusion which might compromise safety.
- When carrying out installation, disassembly, re-assembly, maintenance, operation, adjustment and maintenance work always observe the shut-down procedures described in the operating manual. Never perform this kind of work on the machine unless it is fully shut down.
-  – Before performing such tasks make sure the drives and additional mechanisms of the baling press cannot be switched on unintentionally. Turn the main switch to the “0” position and secure it. Pull out the power plug.
- Before starting the machine after repairs, make sure all protective devices are in place.

- Do not carry out any tasks which may endanger your safety while operating the machine.
- Any changes which take place and could impair safety should be reported immediately. Put the machine out of operation until the damage is rectified.
- Always make sure the machine is in perfect condition before you switch it on.
- Make sure the area around the machine is clean and safe.
- Unauthorised modifications and changes to the machine are strictly prohibited. Protective devices may not be removed or otherwise rendered inoperative.
- No work on the machine which is not part of its normal operation may be performed while the machine is still running.
- Never open doors and flaps before the machine has been shut down. Note the instruction plate.
- Test the protective measures installed after any electrical or repair work.
- No platforms or other raised surfaces may be placed near the shredder press combination if they encroach on the specified safety clearances.
- Connecting cables must be laid in such a way that they cannot be tripped over.
- Only persons with the appropriate skills and experience in hydraulics may carry out work on the hydraulic equipment.
- All lines, pipes and bolted joints must be regularly inspected for looseness, leaks and visible damage. Any damage must be repaired immediately. Escaping oil can cause fire and injury.
- Any parts of the system and hydraulic pressure lines that need to be opened must be depressurised according to the assembly instructions before commencing repair work.

1.4 Proper use

The **SP 5080** shredder press combination is intended **solely** for shredding and pressing paper and cardboard. The robust cutting unit is unaffected by staples and paper clips and is even suitable for the destruction of whole volumes of files and folders. Excluding other types of materials.

Mode of operation:

The above mentioned material is fed into the Shredder. The shredded material falls through the discharge chute of the shredder directly into the hopper of the press. The press cycle is initiated by a light barrier in the hopper when it has been filled to a certain level. The press ram is extended and pushes the material into the press chamber, where it is compacted. The shredder continues to run during the press cycle. As soon as the bale has reached a certain length, it has to be ejected into a gusseted bag. Thereafter pressing can continue.

Any other use is considered improper. The manufacturer accepts no liability for damage resulting from improper use - the operator carries sole responsibility for such use.

Proper use also includes carrying out installation, assembly, disassembly, start-up, operation and maintenance work as prescribed by the manufacturer. The baling press may only be operated, serviced and repaired by staff who are familiar with these regulations and aware of the dangers.

The shredder press combination may only be operated by authorised, trained staff. Do not carry out any tasks which may endanger your safety while operating the machine.

The relevant accident prevention regulations and any other generally recognised health and safety standards must also be observed.

1.5 Inspecting the safety devices

Check the safety devices:

- at the start of every work shift (when operation was interrupted)
- at least once a week when the operation is interrupted
- after each maintenance or repair

Check the safety devices for:

- specified condition
- specified position
- safe attachment
- specified function

Use the following checklist for your inspection. Correct any defects before starting the machine!

If any defects arise during operation stop the machine immediately and ensure that the defect is corrected.

Do not modify or remove any of the protective devices. Do not deactivate any of the protective devices by modifying the machine.

Modifications to the machine are prohibited for safety reasons!

Checklist for inspecting the safety devices

Use the following list for your inspection of the safety devices.

Photocopy it for regular inspections.

Tick off the boxes if the check was successful.

Do not start the machine until you have checked every point.



1. All protective plates must be mounted and firmly bolted on. (see picture)

2. The control cabinet must be closed and the "Lightning symbol" warning sign affixed to it.



3. Check the safety switch on the hopper. The safety switch switches the shredder press combination off immediately and prevents it from being switched on again when the inspection flap is opened.

Try this function out!



4. When you press the emergency stop switch bar whilst the machine is running, the shredder and baling press must switch off immediately. The machines can only be switched on again once you have pulled out the switch bar.

Try this function out!

Ein-Mann-Bedienung
One-man operation
Un seul opérateur

5. The safety sticker “One-man operation” must be fixed to the shredder.



6. The “Safety instruction symbol” sticker must be fixed to the shredder.

Inspected
Date.....
Signature.....

2 Technical data

2.1 Power requirement and fuse rate

	Security level 2 - 3	Security level 4
Voltage	3 x 400 V / 50 Hz	3 x 400 V / 50 Hz
Net	3P+N+PE	3P+N+PE
Power	11,5 kW	13,5 kW
Fuse	32 A	32 A
Rated current	32 A	32 A

2.2 KP 80 Combined press

Weight	approx. 600 kg
Size (L x W x H)	2335 x 945 x 1400 mm

Press data

Pressing force	80 kN
Specific pressing force	30 N/cm ²
Cycle time when idling (theoretical)	18-20 s
Bale size (L x W x H)	800 x 570 x 490 mm
Bale weight (depending on material)*	50 - 70 kg

Motor data

Rated power P _n	4,0 kW
Operating voltage U	3 x 400 V / 50 Hz
Rated current I _n	8,3 A
Protection class	IP 55

Hydraulics

Operating pressure	210 bar
--------------------	---------

Pump

Discharge Q	19,5 l/min
-------------	------------

Cylinder

Pressing cylinder	Ø 70/50 x 1000 mm
-------------------	-------------------

Oil tank

Capacity	20 l
Oil grade	multi-grade oil (DIN 51524-T3) ISO viscosity grade HVLP 22

Noise emission

The sound pressure level does not exceed 80 dB(A)

*)Bale weight : The bale weight varies depending on the type, humidity and condition of the compressed material and on bale length / height.

2.3 FA 500.3 Shredder

Cutting type	Particle cut				
	Cutting size (mm)	10,5 x 40 - 76	7,5 x 40 - 76	6 x 40 - 53	1,9 x 1,5
Security level DIN 66399	P-2/O-2/T-2/E-2	P-3/O-2/T-3/E-2	P-3/O-2/T-3/E-2	P-5/O-4/T-5/E-4/F-2	
Security level DIN 32757	2	2	3	4	
A4 (sheet) cutting performance	70 g/m ²	600 - 650	500 - 550	400 - 450	120 - 130
	80 g/m ²	510 - 550	425 - 470	340 - 380	90 - 100
Throughput security level 4				200 – 250 kg/h	
Intake width	500 mm				
Cutting speed	210 mm/s				
Power supply	3 x 400 V, 50 Hz				
Rated power motor	7,5 kW			5,5 + 4 kW	
Rated current at rated cutting capacity	27 A			31 A	
Plug	Industrial plug				
Fuse	Typ "gl" 35 Ampere				
automatic cutout	K or C / 32 Ampere				
Ambient conditions for transport, storage and operation:					
Temperature	-10 °C bis +40 °C				
Relative humidity	max. 90%, without condensation				
Altitude above sea level	max. 2.000 m				
Dimenstions W x D x H	1170 x 1795 x 1795 mm				
Weight	790 kg			920 kg	
Sound pressure level	75 dB(A)				
Shredded material container volume	530 l (2 x 265 l)				

2.4 Operating conditions

Operating temperature	- 10°C ÷ + 40°C
Operating humidity	max. 90%, without-condensing
Operating altitude	max. 2000 m above sea level

2.5 Accessories

PE gusseted bag	570/490 x 1400 x 0,075 mm
Order no.: 6.209.995.000	

2.6 SP 5080 explanatory diagram

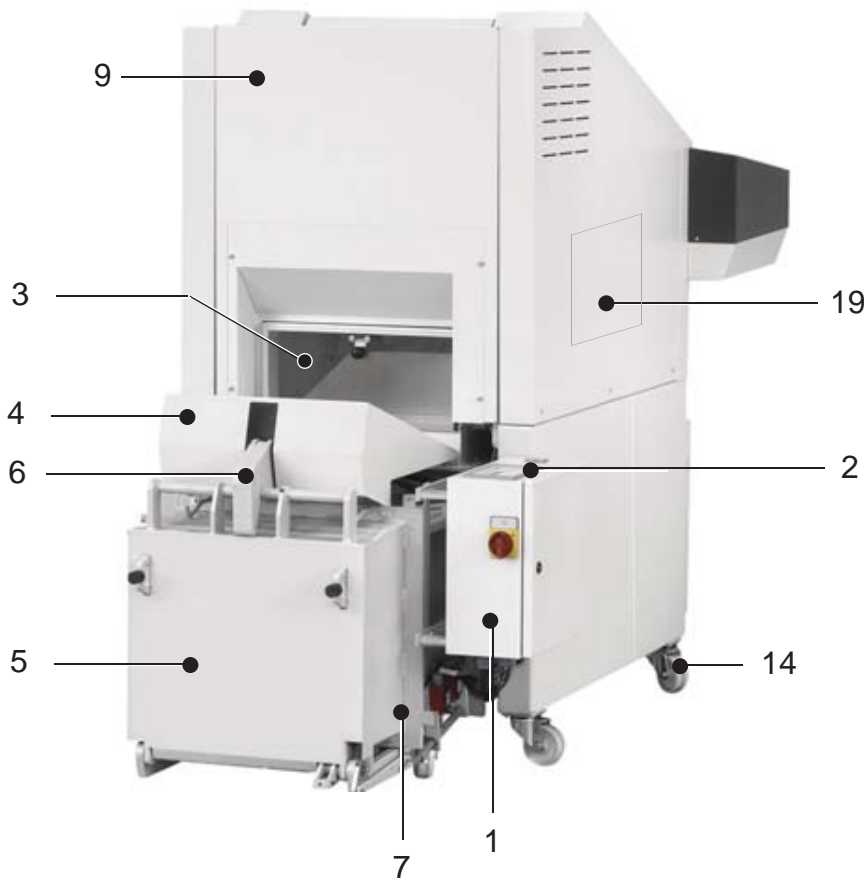

- 1 Press control cabinet
- 2 Press control panel
- 3 Press inspection flap
- 4 Safety flap door lock
- 5 Counter plate
- 6 Door lock
- 7 Press chamber
- 8 Hydraulic cover

- 9 FA 500.3 Shredder
- 10 Loading table
- 11 Shredder control panel
- 12 Emergency stop switch bar
- 13 Feed belt
- 14 Swivel roller with brake

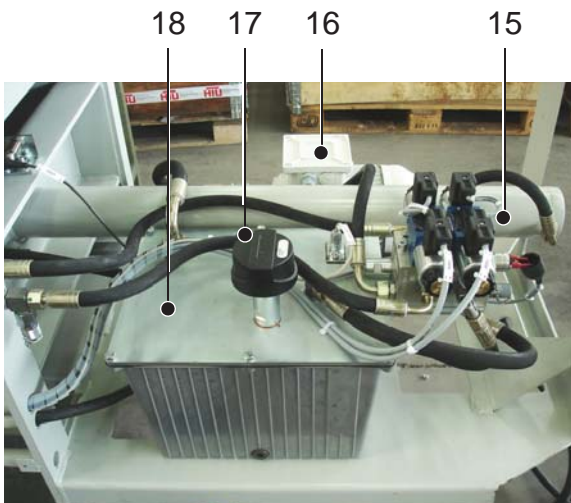
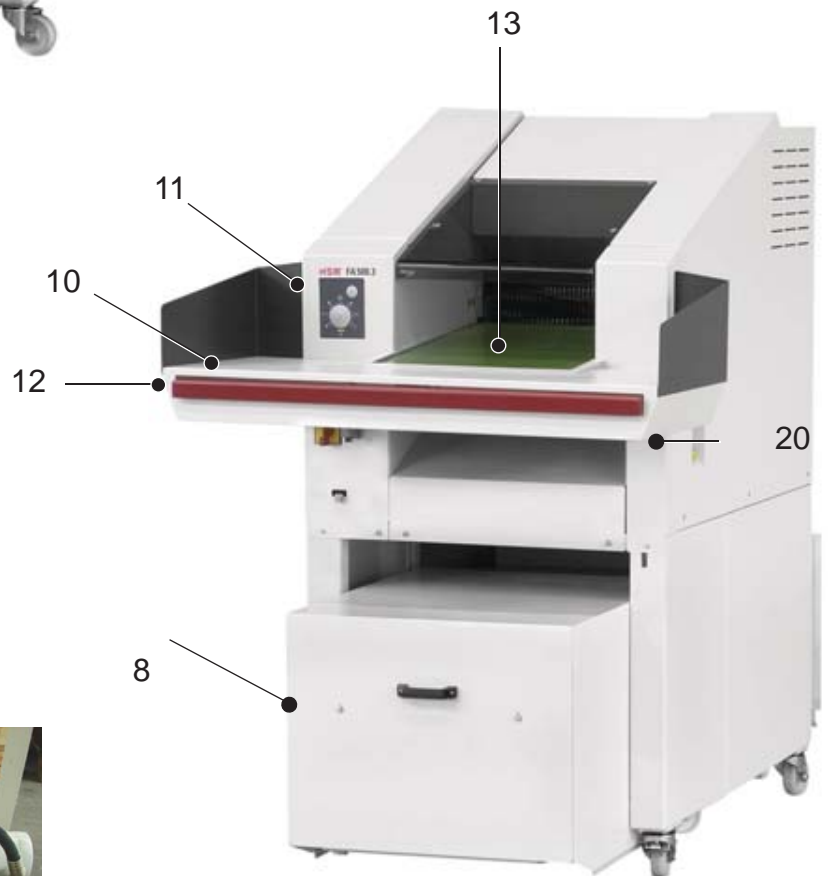

- 15 Pressing cylinder
- 16 Press motor
- 17 Venting filter
- 18 Hydraulic tank
- 19 Shredder inspection flap
- 20 Oil reservoir opening

2.7 Machine dimensions

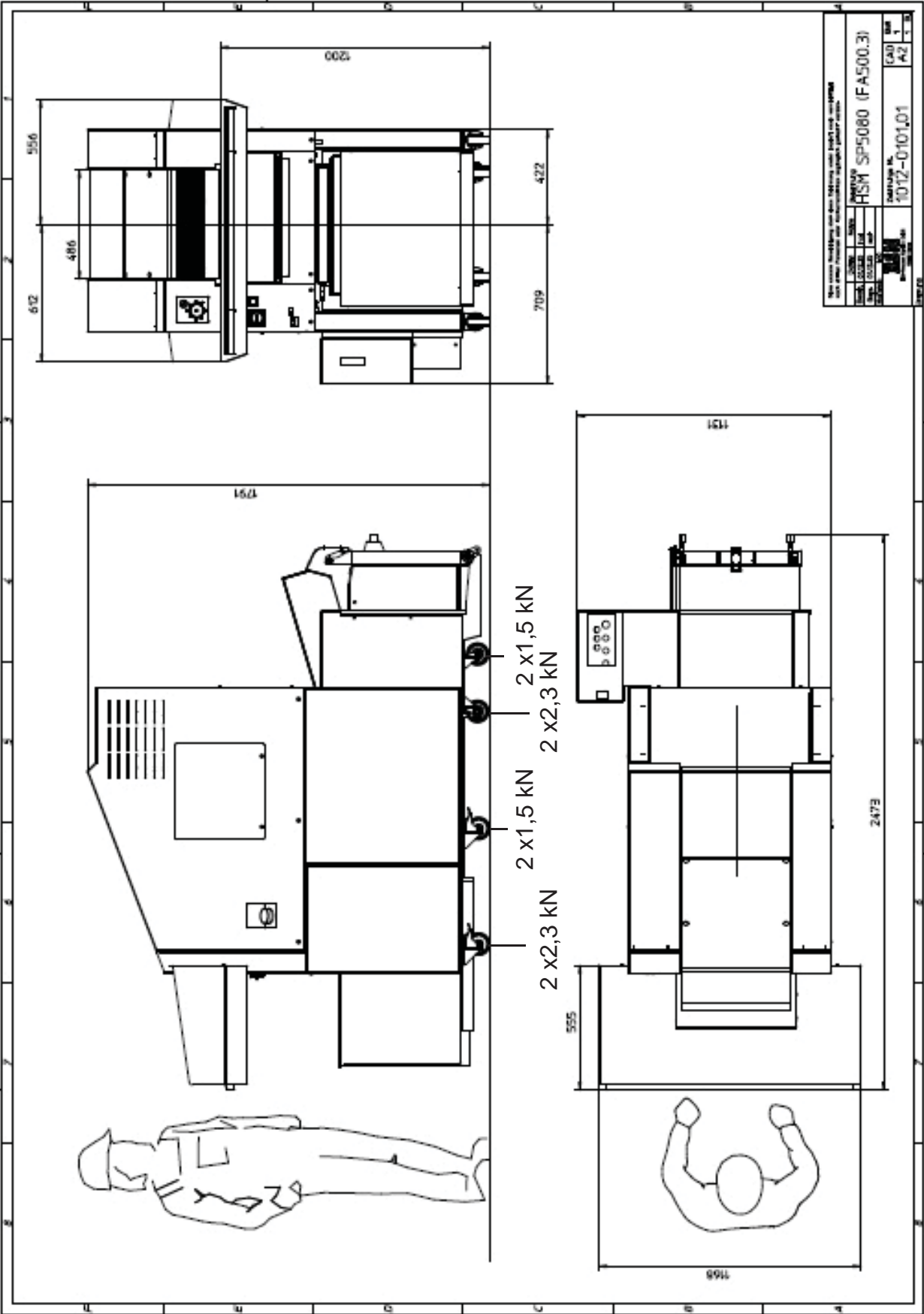

3 Preparations

3.1 General instructions

We strongly recommend that installation work on the baling press should be carried out by trained HSM engineers.

We accept no liability for damage resulting from incorrect installation.

If you do perform installation tasks yourself, make sure you have read and fully understood the entire operating manual before you start.

3.2 Siting the machine

When deciding where to install the machine (e.g. planning by the customer) make sure there is enough space around the machine so that assembly and repair work can be carried out without obstruction. Upstream and downstream machines are to be arranged accordingly.

The installation on the prepared foundation must be carried out in such a way that the shredder press combination is level.

The shredder press combination may only be operated in dry rooms.
At temperatures below 0 °C and above 30 °C respectively, use different hydraulic oil that has a suitable viscosity for the baling press or upgrade the tank heater/oil cooler.

3.3 Supply connections

Power is supplied via the central control cabinet of the baling press. The control cabinet has a power connection cable with a CEE plug.
The installation site must have a CEE 5x32A/6H power socket with an appropriate fuse. (see "Technical data")

3.4 Settings

In general, all the components have been installed, and the electrical and hydraulic lines connected.

The electrical and hydraulic settings for the various components have been performed by HSM.



Caution!

Unauthorised adjustments to the set values are prohibited and could seriously damage the machine.

3.5 Transporting the baling press

Always use the special bearing points for loading the machine from a lorry using a forklift.



- Place the baling press on a smooth level surface at the installation site.
- Remove the packaging foil and dispose of it in a manner that is environmentally sound.
- Cut through the steel straps.
- Using a forklift, lift the baling press by approximately 10 cm and remove the wooden blocks.
- Open the inspection flap and remove all the items delivered with the machine from the press chamber.

3.5.1 Transport to another application site

If only a short distance has to be covered, the baling press can be rolled to the application site. The new installation site must have a sufficient floor loading capacity and comply with the space requirements as well as having an appropriate power socket.



Caution!

Installations on the electrical system or control cabinet may only be carried out by a qualified electrician or one of our service engineers.

3.6 Transporting the shredder

**Caution!**

When moving the shredder, note that it may topple over. Danger of falling over!

- Place the shredder on a smooth level surface at the installation site.
- Remove the packaging foil and dispose of it in a manner that is environmentally sound.
- Cut through the steel straps.
- Roll the shredder off the pallet in accordance with the unpacking instructions. The shredder can now be moved on its rollers.



- The loading table must be mounted at the installation site.

3.7 Assembling the shredder

The shredder is not fully assembled on delivery.

The loading table is not assembled and should only be assembled at the installation site.

- Attach the table using the M10 nuts (1)

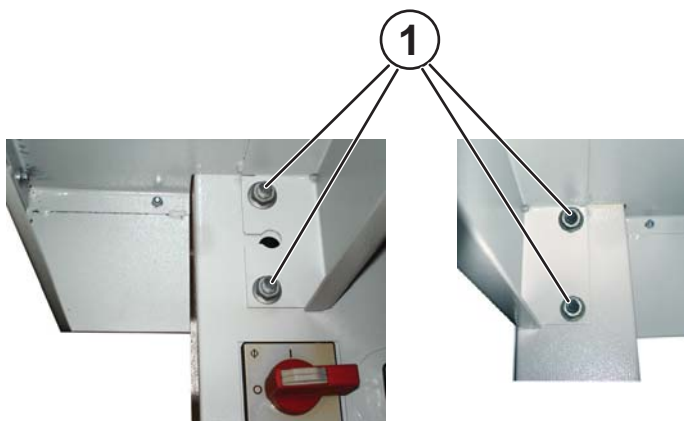
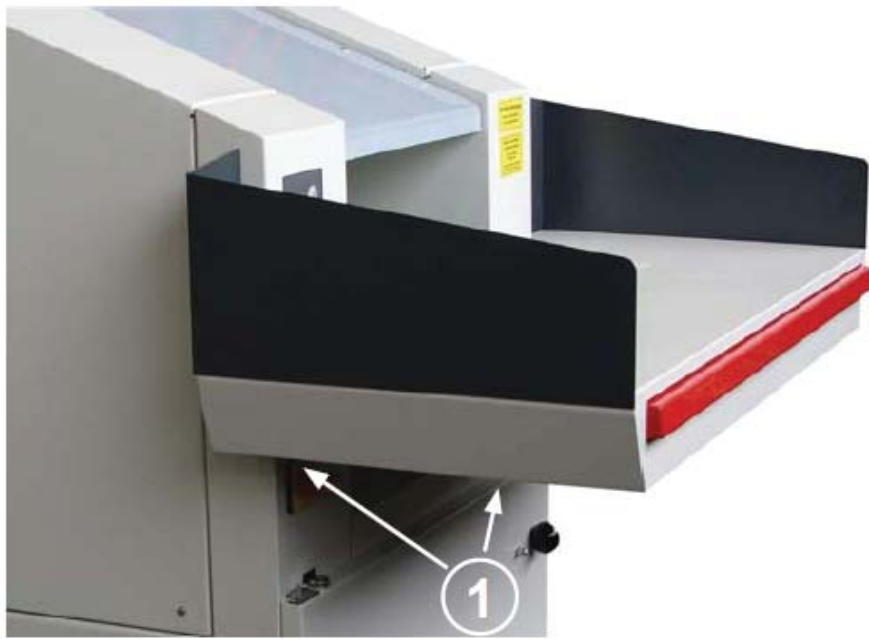

- Insert the plug (connection for the emergency stop switch bar) into the socket and turn it to stop.



3.8 Assembling the shredder press combination



Danger!

Open shearing point, blade rollers.

Risk of fingers and hands being severed.

Neither the shredder nor the combined press may be switched on before both devices have been properly connected and bolted together!

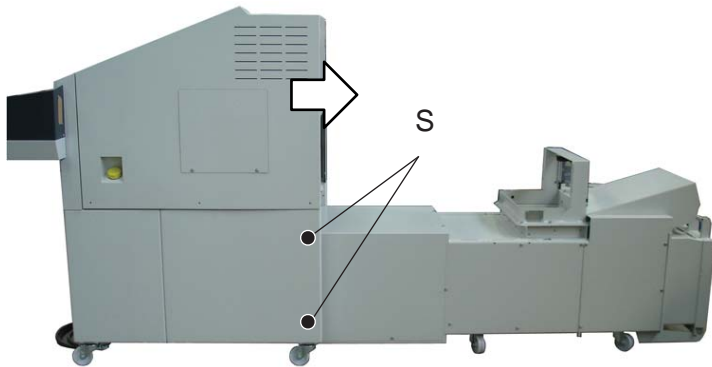

1. Remove the 2 cross braces (S) on the shredder and lock the roller brakes on the press.
2. Push the shredder over the press from behind.
3. Insert the plug of the connection cable into the socket of the shredder and lock the plug in position.
4. Carefully push it forward until the discharge chute of the shredder touches the press hopper. Take care with the cable whilst doing so.
5. If the Shredder cannot be completely pushed up against in the press hopper, the cover (A) must be loosened and subsequently retightened.
6. Bolt the shredder and the baling press together using the 4 nuts.

7. Attach the cover plate (B) using the 4 fillister head screws

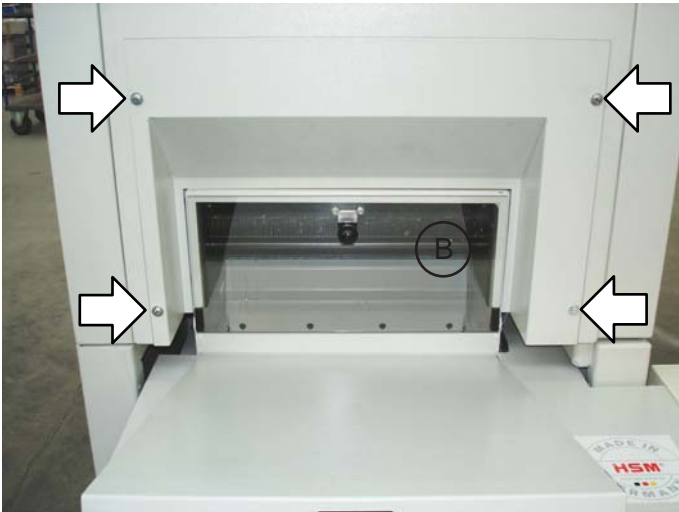

8. Insert the plug of the connection cable into the socket of the baling press and lock the plug in position.





9. Then lock the roller brakes on the shredder.

10. Inspect the safety devices. Use the checklist in section 1 for the inspection.

4 Commissioning

4.1 Baling press controls

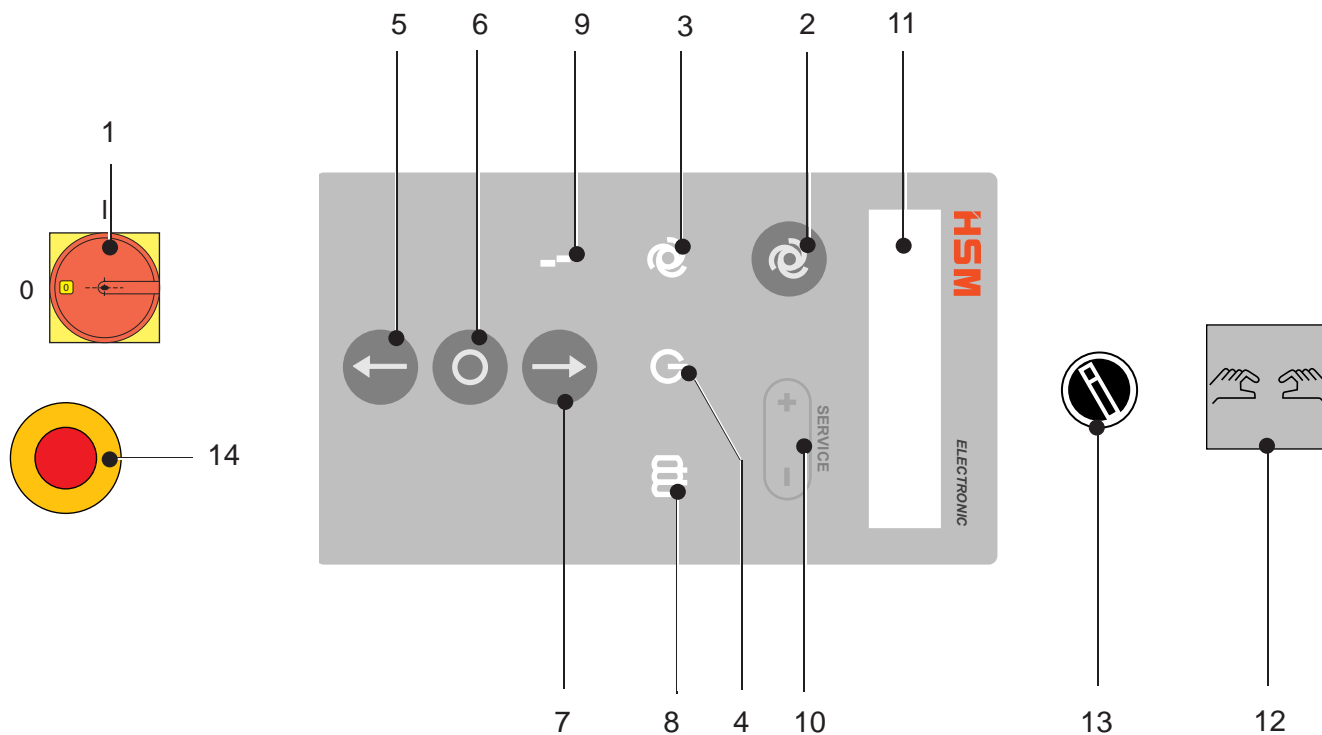

- 1 Main switch
- 2 Automatic mode
- 3 Automatic mode (LED)
- 4 Standby (ready indicator)
- 5 Press ram forward
- 6 Press ram stop
- 7 Press ram backward
- 8 Bale ready
- 9 Malfunction
- 10 Menu selection / scroll up (+) / down (-)
- 11 Text display
- 13 Bale length
- 14 Emergency stop (optional)

Only in set-up mode or during bale ejection:

- 12 Two hand control key
- 7 + 12 Release door lock
- 5 + 12 Fasten door lock

Only whilst counter plate is open:

- 5 + 12 Press ram forward
- 7 + 12 Press ram backward

Main switch (1)

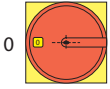

The main switch is on when it is turned 90° to the right.
In the “Off” position, the main switch can be secured with a padlock.



“Automatic mode” key (2)

This key switches the baling press into automatic mode. Deselect the automatic mode by pressing the key again.



“Automatic mode” LED (3)

This symbol lights up white as soon as the automatic mode is switched on.



“Standby” LED (4)

This symbol lights up green as soon as the main switch is switched on and the machine receives power.

This symbol flashes in the set-up mode or with the “Bale ready” message



“Press ram forward” key (5)

(arrow in direction of pressing)

This key starts the press cycle. The press ram moves forward and presses the material. After the compression time has expired, the press ram automatically moves to the rear limit position. The motor switches off.



“Stop press ram” key (6)

This key is used to stop the press ram in any position.



“Press ram backward” key (7)

(arrow opposite direction of pressing)

This key moves the press ram back to the rear limit position.



“Bale ready” LED (8)

This symbol lights up blue as soon as the bale has reached a set size. The press ram stops, and the press and shredder switch off.

Indicator: Bale ready
2-hand control

The “Press ram status” symbol lights up yellow on the shredder control panel. The cutting unit of the shredder can now only be run backwards.

The “Bale ready” message remains active until the counter plate is closed. Then the

Indicator: Manual mode

Bale number: xxx (= daily bale meter reading) appears.

To clear the “Bale ready” signal

- Press the +/- keys simultaneously for about 3 seconds

Indicator: Service menu – Set-up mode

- Simultaneously press the +/- keys again for about 3 seconds

Indicator: Caution! – Set-up mode (fl ashes)

- Press both “Press ram forward” keys and run the press ram for approx. 3 seconds under pressure >> “Bale ready” – signal goes out.



“Malfunction” LED (9)

This symbol lights up red as soon as a malfunction occurs in the baling press. The press and shredder switch off.

(-> see also “**Malfunctions**”)

The machine cannot be started whilst this message is active!



+ / – Keys (10)

Press the +/- keys to scroll through the menu items.

See also the following pages.

Text display (11)

The text display shows the operating conditions and error messages. (-> see also “**Malfunctions**”)

Two hand control (12)



Note

This only functions when the "Bale ready" symbol is on, or in the set-up mode.



Two hand control: Open the hydraulic door lock (7 + 12)

If you simultaneously press the two keys (within 0.6 seconds), the door lock is opened.
If you let go of one of these keys, the action stops.



Two hand control: Close the hydraulic door lock (5 + 12)

If you simultaneously press the two keys (within 0.6 seconds), the door lock is closed.
If you let go of one of these keys, the action stops.



Two hand control: Press ram forward (5 + 12)

If you simultaneously press the two keys (within 0.6 seconds), you can run the press ram forwards whilst the counter plate is open. If you let go of one of these keys, the press ram stops.



Two hand control: Press ram backward (7 + 12)

If you simultaneously press the two keys (within 0.6 seconds), you can run the press ram backwards **whilst the counter plate is open**. If you let go of one of these keys, the press ram stops.



Bale length (13)

By turning the switch, 2 bale lengths or bale weights can respectively be set. This depends on the position of the inductive switch. (on the side of the press chamber)

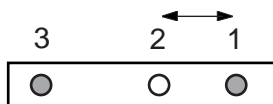

Inductive switch in hole 1 and 3: : 30 kg / : 80 kg
Inductive switch in hole 2 and 3: : 30 kg / : 60 kg



Emergency stop (14) optional

Turn the emergency stop button counter-clockwise to unlock it. If you press the "Emergency stop" button the power circuit is broken. Thereby switching the press and shredder off.

4.1.1 Accessing the SERVICE menu



Service menu / +/- Keys (10)

The service menu can only be called up in manual mode.

Simultaneously press the +/- keys for approx. 3 seconds to access the **Service** menu item

Use the +/- keys to scroll through the sub-menu items

Set-up mode – Daily bale meter – Total bale meter – Service hours meter – User language – Error memory – System.

Simultaneously press the +/- keys again for approx. 3 seconds whilst in the relevant submenu item, to gain further access within these menus.

Press the +/- keys to scroll through the menus.

Simultaneously press the +/- keys to confirm the values set.

Press any key to return to the main menu.

3 sec. <small>SERVICE</small> 	Sub-menu items SERVICE	3 sec. <small>SERVICE</small> 	
	Set-up mode >>		Caution! Set-up mode
	Daily bale meter >>		Bale count: xxx clear? yes/no
	Total bale meter >>		Bale count: xxx
	Service hours meter >>		Service hours: xxx
	User language >>		GB (D, F, ...)
	Error memory >>		XXXX
	System >>		Menu timing

4.1.2 Set-up mode

4.1.2.1 Pressure plate forward-backward / door lock open-close

- Press the +/- keys simultaneously for about 3 seconds
Indicator: Service menu – Set-up mode
- Simultaneously press the +/- keys again for about 3 seconds
Indicator: Caution! – Set-up mode (fl ashes)



Two hand control: Open the hydraulic door lock (5 + 12)

If you simultaneously press the two keys (within 0.6 seconds), the door lock is opened.
If you let go of one of these keys, the action stops



Two hand control: Close the hydraulic door lock (5 + 12)

If you simultaneously press the two keys (within 0.6 seconds), the door lock is closed.
If you let go of one of these keys, the action stops



Two hand control: Press ram forward (5 + 12)

If you simultaneously press the two keys (within 0.6 seconds), you can run the press ram forwards whilst the counter plate is open. If you let go of one of these keys, the press ram stops.



Two hand control: Press ram backward (7 + 12)

If you simultaneously press the two keys (within 0.6 seconds), you can run the press ram backwards whilst the counter plate is open. If you let go of one of these keys, the press ram stops.



4.1.2.2 To exit set-up mode

- Simultaneously press the keys “Close the hydraulic door lock” for about 5 seconds



4.1.3 To display / clear the daily bale meter

- Press the +/- keys simultaneously for about 3 seconds
Indicator: Service menu – Set-up mode
- Press the + key 1x
Indicator: Service menu – Daily bale meter
- Press the +/- keys simultaneously for about 3 seconds
**Indicator: Bale count xxx
clear? yes/no**
- Use the +/- keys to scroll to the required menu item
clear yes / clear no
- Press the +/- keys simultaneously to confirm

4.1.4 To display the total bale meter

- Press the +/- keys simultaneously for about 3 seconds
Indicator: Service menu – Set-up mode
- Press the + key 2x
Indicator: Service menu – Total bale meter
- Press the +/- keys simultaneously for about 3 seconds
**Indicator: Bale count
xxx**

4.1.5 To display the service hours meter

- Press the +/- keys simultaneously for about 3 seconds
Indicator: Service menu – Set-up mode
- Press the + key 3x
Indicator: Service menu – Service hours meter
- Press the +/- keys simultaneously for about 3 seconds
**Indicator: Service hours
xxx**

4.1.6 To set the user language

The text display can be set to different user languages.

The options available are:

D - GB - F - E - I - P - NL - (N - S - FIN - DK - GR - TR - PL - CZ - RUS

- Press the +/- keys simultaneously for about 3 seconds
Indicator: Service menu – Set-up mode
- Press the + key 4x
Indicator: Service menu – User language
- Press the +/- keys simultaneously for about 3 seconds
Indicator: User language – GB
- Use the +/- keys to scroll to the required menu item
- Press the +/- keys simultaneously to confirm
Indicator: Manual mode – Initial position

4.1.7 To display the error memory

For diagnostic purposes, the most recent error is stored in the error memory. For error numbers, see the section “**Malfunctions**”

- Press the +/- keys simultaneously for about 3 seconds
Indicator: Service menu – Set-up mode
- Press the + key 5x
Indicator: Service menu – Error memory
- Press the +/- keys simultaneously for about 3 seconds
Indicator: Error memory
xxxx

4.1.8 System

This menu item is only available to HSM service technicians.

4.2 Shredder control panel

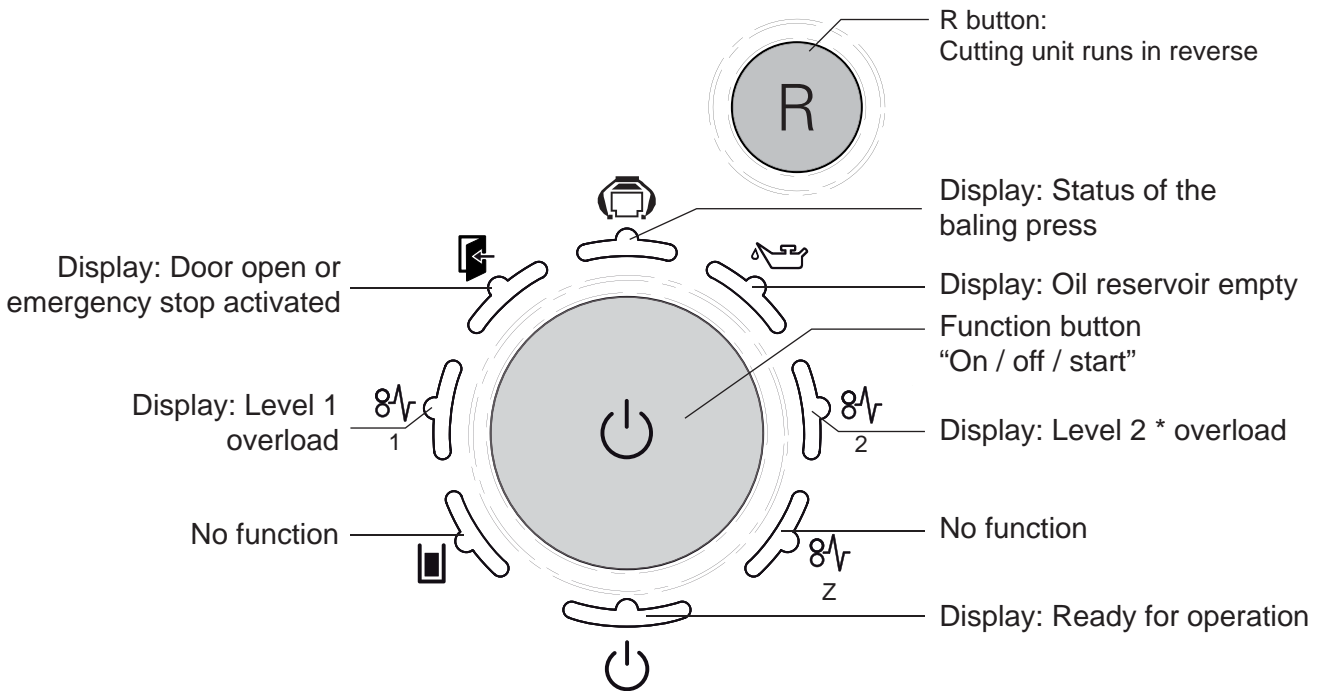

Note

The shredder can only be operated, whilst the press is in automatic mode.

4.2.1 Display: Baling press not in automatic mode

This symbol lights up red, if the press is not in automatic mode.

4.2.2 Display: Status of the baling press

This symbol lights up

green, whilst the press is in automatic mode.
 yellow, when the bale is ready for strapping.
 red, if a malfunction occurs in the baling press.

4.3 Initial start-up

- Open the inspection door on the hopper and check that the press chamber is clear, and remove any spare parts or supplies delivered with the machine
- Insert the CEE Plug into the socket on site.
- Activate the emergency stop control by pushing the switch bar away from the machine.
- *Unlock the emergency stop on the press. (optional).*
- Switch on the main switch of the press and the shredder.

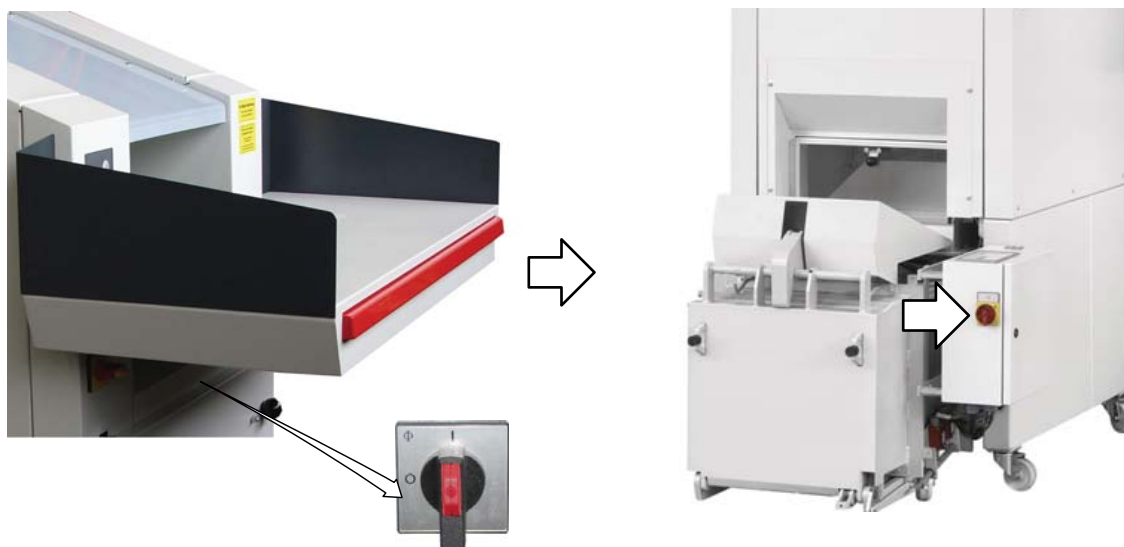

- After a self-test by the control, the **Indicator: Manual mode – Initial position**, appears
- If the error number 1000 (= phase is absent) or 1010 (= counter-clockwise phase rotation) appear in the display -> call an electrician! See also the “Malfunctions” section



Warning!!



Faults in electrical components and supply cables may only be attended to by qualified electricians or HSM service engineers.

- Close the control cabinet, before continuing to commission the machine.
- Set the desired user language

4.4 Using the machine

4.4.1 Fit the plastic bag and start the machine

- Press the +/- keys simultaneously for about 3 seconds
Indicator: Service menu – Set-up mode
- Simultaneously press the +/- keys again for about 3 seconds
Indicator: Caution! – Set-up mode (flashes)

- Open the hydraulic door lock ( + )
- Take hold of the counter plate (1) using both hands **from the front** and lower it all the way down

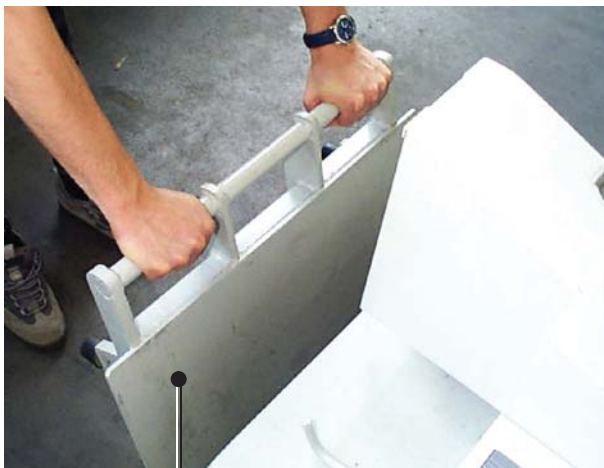

1

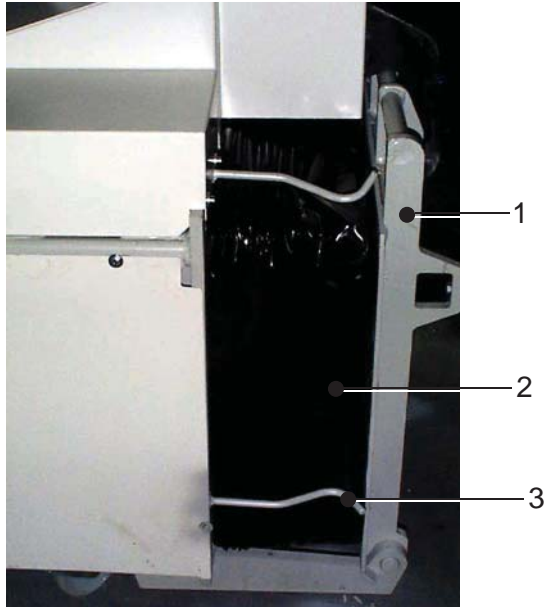



Accessories:

PE gusseted bag

U=2120mm / L=1400mm /
S=0,1mm

Part no.: 6.209.995.000

- Pull the plastic bag (2) over the discharge outlet and gather it under the 4 retaining bows (3)
- Close the counter plate manually again

- Lock the hydraulic door lock ( + )



- Press the "Automatic mode" key on the press
 - the white "Automatic mode" LED lights up
- Indicator: Manual mode – Initial position**



- "Ready" display lights up green on the shredder.



- "Baling press status" display lights up green on the shredder.





- Press the start button
- the cutting unit and feed belt start up

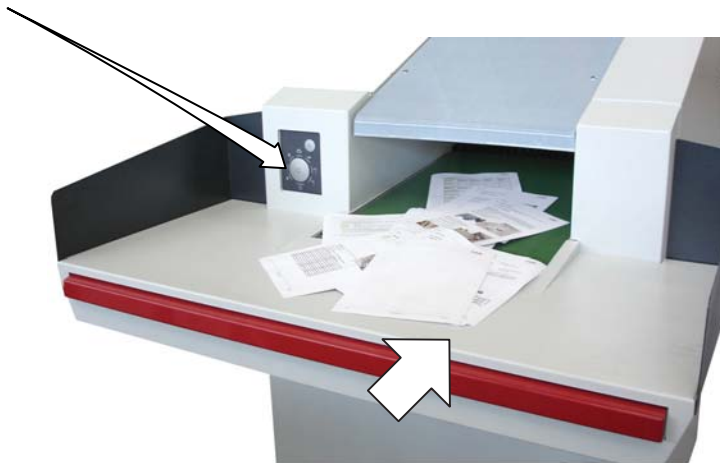

- Place the material to be shredded on the loading table and then place batches on the feed belt

If material that is not supposed to be shredded is mistakenly placed onto the conveyor belt do not try to pull it out

- Press the start button again
- the drive stops



- Press the R button
- the cutting unit and feed belt run in reverse
- When the R button is released the shredder comes to a stand still
- The material can now be removed from the conveyor belt and the shredder can be started again with the start button



Note

Provided the cutting unit is running in the shredding direction, you can stop it by pressing the R button.



The shredded material falls through the discharge chute of the shredder directly into the hopper of the press.

The press cycle is initiated by a light barrier in the hopper when it has been filled to a certain level. The press ram moves forward and presses the material. After the compression time has expired, the press ram automatically moves to the rear limit position. The shredder continues to run during the press cycle.



The filling and press cycle continues until the "Bale ready" message appears in the display and the blue "Bale ready" LED lights up.

The press ram goes into a position for unloading. The press and shredder switch off.

4.5 Ejecting and bagging the bale

- Open the hydraulic door lock ( + )
- Take hold of the counter plate using both hands **from the front** and lower it all the way down



- Now press both ( + ) keys and keep pressing them until the press ram automatically stops.
- The press ram is extended and pushes the bale into the plastic bag.



- Take hold of the plastic bag at the bottom of the press firstly and then pull it carefully off the discharge outlet
- Lift the plastic bag up at its opening, so that you can stand the bale up
- Fold the ends over each other and seal the bag with adhesive tape





- Tilt the packed bale carefully on to a EURO pallet (2 bales can be stacked on a EURO pallet)



- Pull a new plastic bag over the discharge outlet
- Lift the counter plate up again
- Scraps of paper lying on the floor, can be emptied into the press through the inspection flap
Indicator: Hopper is open!



- Close the inspection flap again
- Press both ( + ) keys for approx. 5 seconds to lock the hydraulic door
Indicator: Manual mode
Bale count: xxx (= daily bale meter reading)



- Press the "Automatic mode" key on the press
 - the white "Automatic mode" LED lights up
 - the press ram goes into the initial position
 - the machine is ready for operation again

4.6 Malfunctions of the baling press

As soon as a malfunction occurs in the baling press, the red malfunction symbol  lights up. The baling press and shredder switch off and the relevant error message appears in the text display.



The “Baling press status” symbol  lights up red on the shredder.

The error number of the most recent error is stored in the error memory. Diverse, displayed error messages can be cleared by simultaneously pressing the + / – keys or by turning the machine on and off.

Service - Hotline: +49 75 54/2100-300

4.6.1 Error numbers

Code	Description	Remedy
1000	One of the phases is missing / power input	Electrician! Check the fuses on site.
1010	A phase is wrong / counter-clockwise phase rotation	Electrician! Phase sequence on site / check phase rotation.
1100	Oil temperature too high	Let oil cool / check oil temperature sensor
1110	Defective oil temperature sensor	Electrician! Replace sensor
1200	Motor overload switch was triggered. Motor too hot	Check motor / reset motor overload switch
1210	Emergency stop on the press has been activated	Unlock the emergency stop button
1211	Emergency stop on the shredder has been activated	Unlock the emergency stop button
1221	Service door in the filling area of the press is open	Close the inspection flap
1231	Defective “Counter flap closed” switch	Electrician! Consult HSM customer service
1232	Counter flap is open	Close the counter flap
1241	Defective “Counter flap 90° open” switch	Electrician! Consult HSM customer service
1271	“Extend press ram” timing	Check the movement of the press ram
1272	“Retract press ram” timing	Check the movement of the press ram
1280	Counter plate not locked	Electrician! Consult HSM customer service
1281	Defective “Bale ready” inductive switch	Electrician! Consult HSM customer service
1285	Defective counter plate locked inductive switch	Electrician! Consult HSM customer service
1300	Defective hardware	Electrician! Consult HSM customer service
1310	Short-circuit master output stage	Electrician! Consult HSM customer service
1320	Short-circuit slave output stage	Electrician! Consult HSM customer service

4.7 Malfunctions of the shredder

4.7.1 Overload due to paper jam



- “Overload” display (level 1 or level 2 – depending on the machine model) lights up red.
- The drive automatically runs in reverse for several seconds. Then the cutting unit switches off.



Caution!

The blade rollers can still cause injuries even while they are not running.

Do not reach into the cutting unit!

Protective gloves should be worn at all times.

Do not repetitively run the cutting unit backwards and forwards, for the purpose of removing an obstruction. This will damage the shredder.



- Remove the stack of paper.
- Press the automatic button on the press
- Press the start button and put less paper on the feed belt.



4.7.2 Electric motor overheats



- “Overload” display (level 1 or level 2 – depending on the machine model) flashes red.
- The drive automatically switches off.



- Let the motor cool down for 20–30 minutes.
- Press the automatic button on the press
- Press the start button.



4.7.3 Emergency stop activated



- Display lights up red.
- The baling press and shredder switch off.



- Activate the emergency stop control by pulling the switch bar away from the machine.
- Press the automatic button on the press
- Press the start button.



4.7.4 Oil reservoir empty



- “Oil reservoir empty” display lights up blue.
- Refill the cutting block special oil.
Order no. 1.235.997.500 for a 5 l container
- After the reservoir is filled, the “Oil reservoir empty” signal is automatically deactivated.



Note

The shredder remains operational even when the oil reservoir is empty.

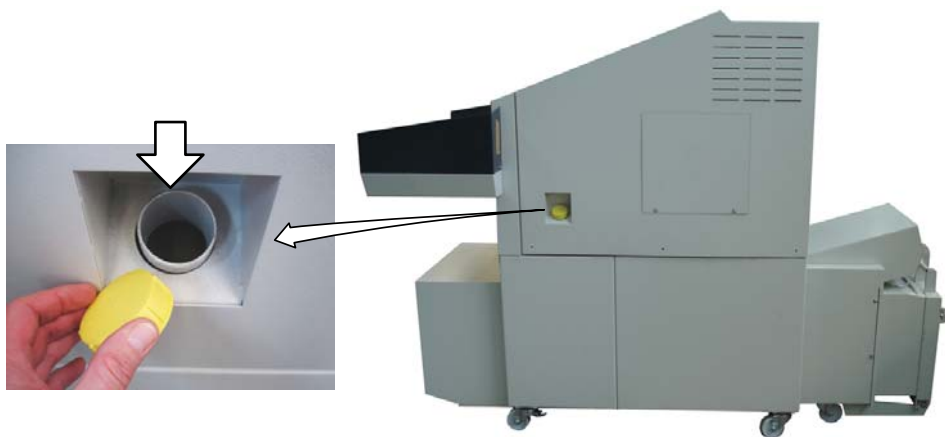

4.8 Stopping the machine

- Run the machine into the initial position (with the press ram at the rear).
- Switch off the main switch of the shredder and of the press
- Secure the main switches against restarting
- Unplug the red CEE power plug

4.9 Outdoor use



Warning!

For reasons of safety, only operate under supervision. The operator must ensure that unauthorized persons do not have access to the machine.

When the machine is not being used, it must be shut down and secured against unauthorised use.

See also the “Siting the machine” section

5 Inspection and maintenance work

5.1 Notes on maintenance

**Note**

Malfunctions which are due to inadequate or incorrect maintenance can lead to expensive repairs and lengthy machine down-times. Regular maintenance is therefore essential. For this reason we recommend a maintenance and inspection contract.

**Warning!**

Correct any damage immediately. Escaping oil can cause fire and injury!

Maintenance and repair work on the electrical system or control cabinet may only be carried out by a qualified electrician or one of our service engineers

All the inspection and maintenance tasks listed here apply to **single-shift operation**. The intervals must be reduced accordingly for multiple shift operation. The baling press must undergo a complete overhaul at least every two years.

Always refer to the “Safety” section during maintenance and inspection work.

Before performing such tasks make sure the drives and additional mechanisms of the baling press cannot be switched on unintentionally. Turn the main switch to the “0” position and secure it. Unplug the red CEE power plug.

Maintenance work may only be carried out by our specialist engineers or specially trained staff.

Only persons with the appropriate skills and experience in hydraulics may carry out work on the hydraulic equipment.

5.2 Maintenance of the combined press

5.2.1 Changing the hydraulic fluid / venting filter

Change the hydraulic fluid and the venting filter **every 2 years**

- Run the press ram to its rear limit position
- Turn off the main switch and disconnect the red CEE power plug
- Disassemble the shredder press combination
(see “Assembling the shredder press combination” section)
- Remove the cover (H)

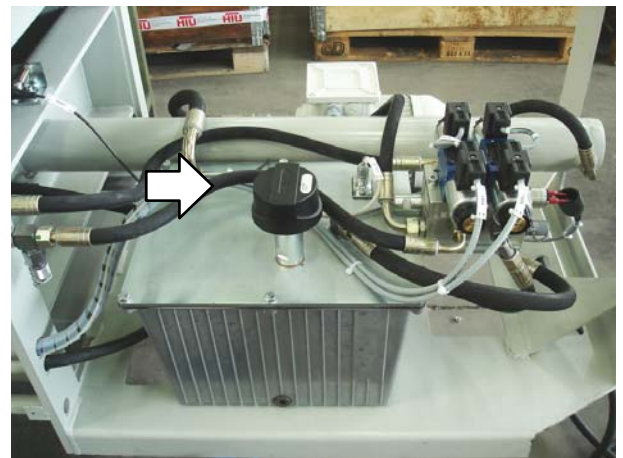

Venting filter
Part. no. 6.116.195.090



- Remove the tank cover and extract the oil with an oil suction unit
- The capacity of the hydraulic fluid tank is ~ 20 l
- If the tank is very dirty, clean it
- Mount the tank cover onto the unit again
- Add oil until a level between the notches on the oil level dipstick is reached

Oil grade:

- in accordance with DIN 51524-T3 multi-grade oil / ISO viscosity grade HVLP 22

	ISO- Viskositäts- klasse	ESSO	DEA	SHELL	ARAL	BP	FINA
Mineralöle Mineral oils	ISO VG 22 HVLP	UNIVIS N 22	Astron ZHLP 22	Tellus Öl T 22	Aral Vitam HF 22	Bartran HV 22	HYDRAN HV 22

- Run the press ram forwards and backwards several times and, whilst the press ram is as far forward as possible, recheck the oil level
- Fill more oil if required
- Screw on a new venting filter
- Mount the cover (H) onto the unit again



Note

Observe the applicable accident prevention regulations when handling cleaning agents and solvents.

Observe the environment protection regulations when disposing of waste oil.

Never mix hydraulic fluid and cleaning agent mixtures with waste oil. Collect these substances in separate containers and dispose of them according to the regulations.

5.2.2 Lubricating the movable parts

The press ram guide (black plastic blocks) is maintenance free. Do not lubricate the tracks in the press chamber!

- Should any grinding or humming noises arise, place a drop of biodegradable lubricating oil on the exposed tracks of the press chamber floor.
- Replace the plastic blocks of the press ram guide every 2 years.
- Consult HSM customer service in this regard.

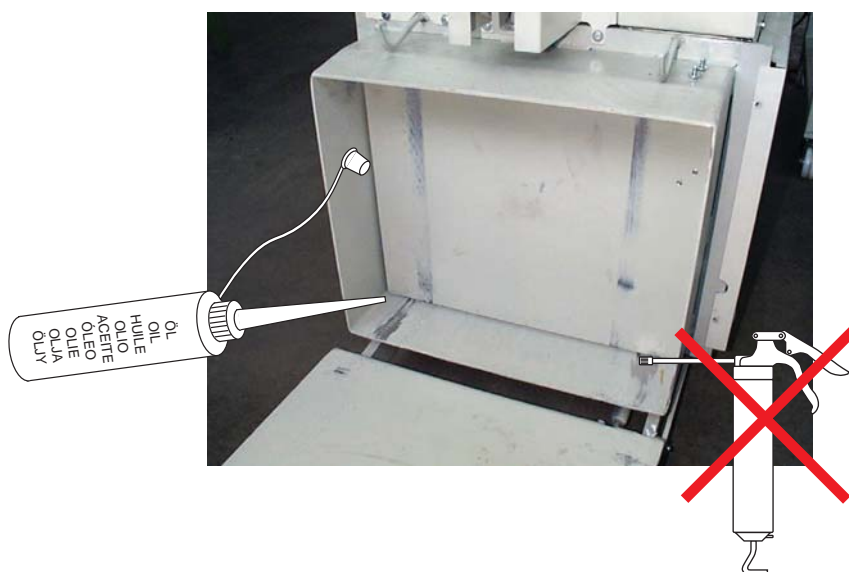

- Lubricate all movable parts and hinges as required, especially the door hinges and the bearings of the door locks with multi-purpose grease or universal lubricating oil.

5.3 Maintenance of the FA 500.3 shredder

5.3.1 Lubricating the drive chains and synchronized wheels (2 x per year)

- Turn off the main switch and disconnect the red CEE power plug
- Remove the inspection flaps (1) in the left and right side plates. Take out the Allen screws (2).
- Lubricate the drive chain of the motor and cutting unit, the drive chain of the cutting unit and feed belt, and the synchronized wheels.
Recommended lubricant: K2K in accordance with DIN 51502/DIN 51825

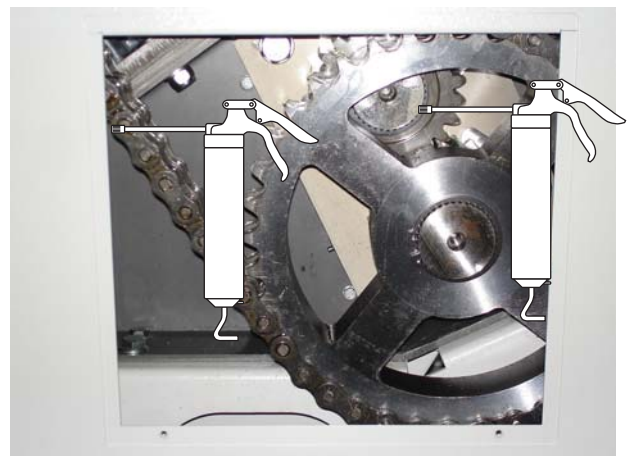

- Mount the inspection flaps onto the unit again.

5.3.2 Retighten the feed belt

- Turn off the shredder
- Loosen the hex nuts (3) on the left and right sides of the snub roller.
(Accessible from the below)
- Loosen the lock nuts (4) of the tensioning bolts (5).
- Tighten the feed belt evenly using the tensioning bolts.

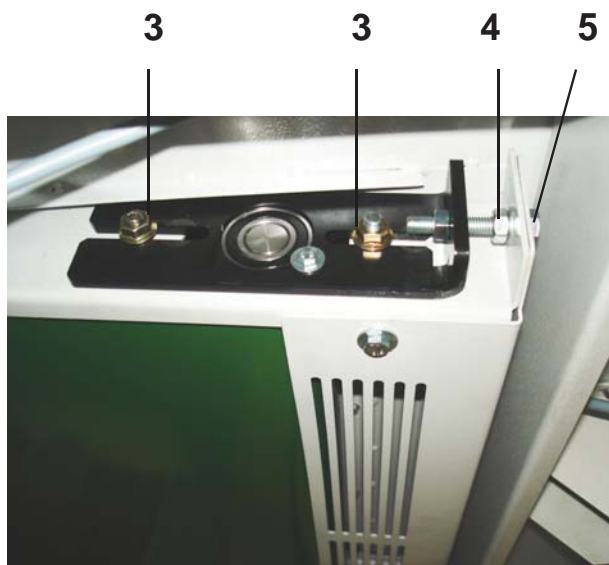

Note

Only tighten the feed belt until it stops slipping. The feed belt bearing may be damaged if it is tightened too much.

- Tighten the hex nuts on the snub roller and the lock nuts on the tensioning bolts again.

5.3.3 Check the directional stability of the feed belt

Switch on the shredder and let it run for approx. 10 minutes.

During this time, the feed belt must run in the middle of the snub roller. If it slips to the left or right edge, you must alter the setting of the snub roller.

5.3.4 Check the feed belt for wear

The surface of the feed belt can become worn after long periods of use. If you can see the fabric inlay in the belt, it must be replaced.

Please notify our customer service.

5.3.5 Emptying the collecting tray

- Empty the dirt tray under the feed belt as required
- Clean the area under the Shredder – vacuum the particles of dirt



6 Storage

If the shredder press combination is to be stored for a lengthy period, make sure that:

- the shredder press combination is disconnected from the power sources
- the shredder press combination is not directly exposed to the weather
- the hydraulic tank, pipes and hoses do not leak

7 Disposal instructions

HSM baling presses / shredders have a long service life. Nevertheless, every machine reaches a time when inspections and repairs are no longer worth the trouble. The operator then faces the problem of disposing of the machine properly

We will be glad to advise you about the legal regulations for disposal at the appropriate time.

The baling press and shredder are made of different materials and need to be disassembled to separate the materials for recycling. (Ferrous materials, electrical components, plastics)

The hydraulic tank, pipes and hoses must be drained. It is important to ensure that leaking or spilled liquids are disposed of using appropriate binding agents or technical facilities, and do not enter the water, the ground or the sewer system. In disposing of the respective hydraulic fluids, the national legal requirements must be observed.

7.1 Disposal verification form

To

HSM GmbH + Co. KG

Austraße 1 - 9

D-88699 Frickingen / Germany

The machine specified here

Designation: Baling press / Shredder

Model: _____

Machine number: _____

Year of construction: _____

has been disposed of according to the applicable regulations.

Address of the last
operating company

Address of the
waste management company

.....
Date and signature
of the last operator

.....
Date and signature
of the disposal company

8 Using and ordering spare parts

Only use original HSM spare parts!

When ordering spare parts, please always provide:

- the complete machine number
- the year of construction of the baling press

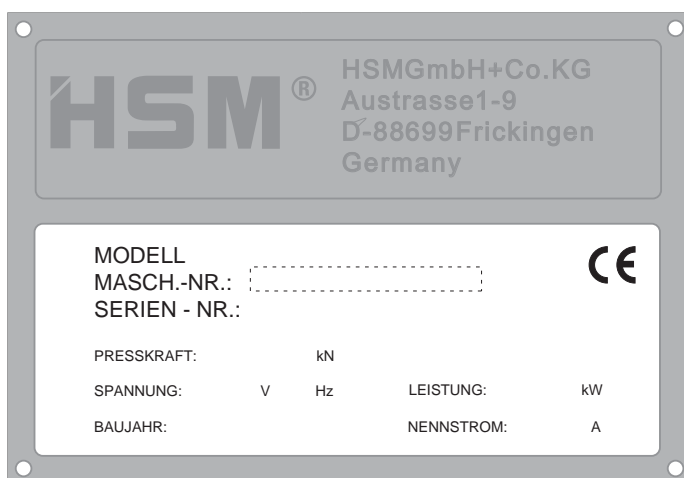

8.1 Customer service address

HSM GmbH + Co.KG
Austraße 1-9
88699 Frickingen, Germany
Tel. +49 7554-2100-300
Fax +49 7554-2100-197
support@hsm.eu

9 Electrical circuit diagrams

Electrical plan is separate in the press

10 KP 80 hydraulic diagram

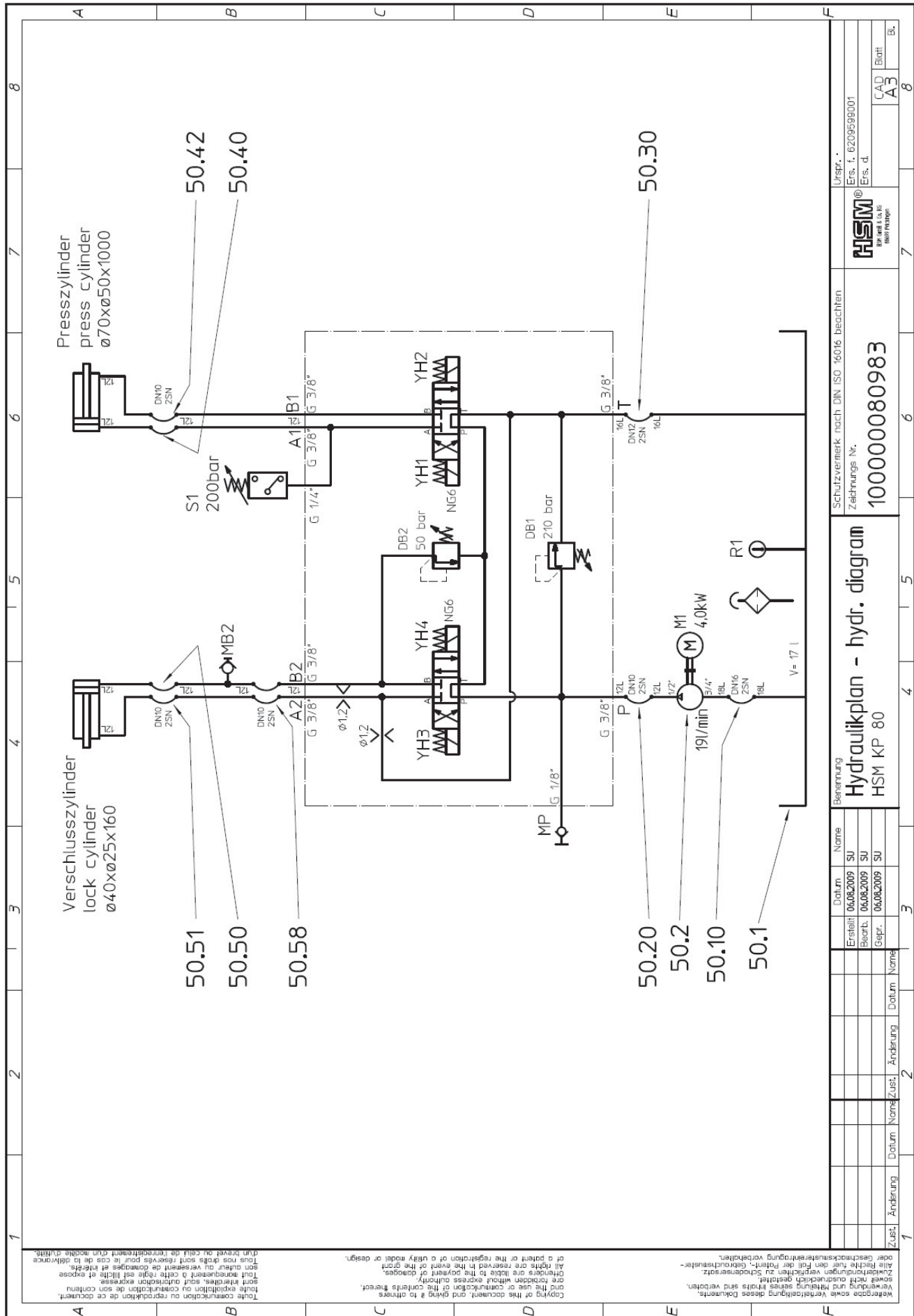

Zust. Änderung		Datum		Name	
1					
2					
3					
Bezeichnung		Hydraulikplan - hydr. diagram			
HSM		HSM KP 80			
Schutzvermerk nach DIN ISO 16016 beachten		Zeichnungs Nr. 100000080983			
HSM		Erspr. t. 6209599001			
Ers. d.		Ers. d.			
CAD		A3			
B.		8			

11 EC declaration of conformity

EC declaration of conformity

The manufacturer **HSM GmbH + Co. KG**
Austraße 1-9
D - 88699 Frickingen

hereby declares that the described **SP 5080 shredder press combination**, consisting of the FA 500.3 shredder and the KP 80 baling press, comply with the basic safety and health requirements of the following EC directives :

- 2006/42/EG
- 2004/108/EG

Applied standards and technical specifications:

EN1010-3:2002+A1, EN ISO 12100-1:2003+A1:2009, EN ISO 12100-2:2003+A1:2009,
EN ISO 13857:2008, EN 13849-1 (2008), EN 60204-1:2006+A1:2009,
EN 349:1993+A1:2008, EN 55014-1:2006+A1:2009, EN 61000-6-4 (01.07), EN 61000-6-2 (03.06)

The individual operation of the machines is prohibited. Only the combination of the shredder and the baling press complies with EN 13857 (safety distances).

Frickingen, 15.02.2011



p. p. Hubert Kötzinger
Head of Environmental Engineering Product Development

Authorised representative for the compilation of technical documentation:
Hubert Kötzinger, HSM GmbH + Co. KG.

The technical documentation in terms of Appendix VII, Part A has been created and is available at HSM GmbH + Co.KG.

This declaration only relates to those machines that are in the same condition as they were when put into circulation, no regard can be to parts added later by the end user and/or any work conducted subsequently.