

FA 500.3

## OPERATING MANUAL SHREDDER



**HSM**<sup>®</sup>  
*Powerline FA 500.3*

english

1.990.999.110 A – 07/2012



**HSM**<sup>®</sup>

**Contents**

1 Proper use, warranty .....3

2 Safety instructions..... 3

3 Overview .....4

4 Dimensions .....5

5 Transportation, installation .....6

6 Operating and display elements .....8

7 Start-up .....8

8 Malfunctions..... 10

9 Maintenance and care ..... 12

10 Disposal / Recycling..... 13

11 Scope of supply, accessories..... 13

12 Technical data ..... 14



**HSM GmbH + Co. KG**  
 Austraße 1-9  
 88699 Frickingen / Germany

Tel. +49 7554 2100-0  
 Fax. +49 7554 2100 160  
 info@hsm.eu  
 www.hsm.eu

**HSM (UK) Ltd.**  
 14 Attwood Road / Zone 1  
 Burntwood Business Park  
 Burntwood  
 Staffordshire  
 WS7 3GJ

Tel. +44(0) 1543.272.480  
 Fax +44(0) 1543.272.080  
 info@hsmuk.co.uk  
 www.hsmuk.co.uk

**HSM of America LLC**  
 419 Boot Road  
 Downingtown, PA 19335

Tel. (484) 237-2308  
 (800) 613-2110  
 Fax (484) 237--2309  
 customerservice@hsmofamerica.com  
 info@hsmofamerica.com  
 www.hsmofamerica.com

**HSM France SAS**  
 Parc de Genève  
 240, Rue Ferdinand Perrier  
 69800 SAINT-PRIEST  
 FRANCE

Tél: +33 (0) 810.122.633  
 Fax: +33 (0) 4.72.51.74.81  
 France@hsm.eu

**HSM Polska SP. z.o.o.**  
 ul. Emaliowa 28  
 02-295 Warszawa

Tel. +48 / 22 862 23 69 / 70  
 Fax +48 / 22 862 23 68  
 info@hsm Polska.com  
 www.hsm Polska.com

**HSM GmbH + Co. KG**  
 Oficina Barcelona  
 C/Tona  
 Nave n° 15 "El Lago"  
 Pol. Ind. Monguit  
 08480 L'Ametlla del Vallès  
 BARCELONA

Hotline Gratuito  
 Tel. 00800 44 77 77 66  
 Fax 00800 44 77 77 67  
 Spain@hsm.eu

## 1 Proper use, warranty

The shredder is exclusively designed for destroying paper and cardboard, as well as store cards, credit cards, CDs, USB sticks and floppy disks. The sturdy cutting unit is resistant to staples and paper clips. You can also shred whole files in machines with cutting widths of 6 x 40 - 53 mm, 7.5 x 40 - 80 mm and 10.5 x 40 - 76 mm.

The document shredder is supplied as a single or combined machine (with an HSM baling press). Please observe the applicable instructions in the operating manual.

Our general business conditions are applicable. We provide a one year warranty for the document shredder. The warranty period is 6 months when used in multiple shifts. This warranty excludes wear, damage due to improper handling, natural depreciation, and actions taken by third parties.

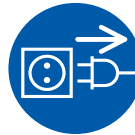

### **Danger of injury**

Do not reach into the paper feed opening.

### **Splinters can cause injury**

Wear protective goggles when destroying diskettes, CDs and hard credit cards.

### **Danger of injury during intake**

Do not go near the paper feed opening with long hair, loose clothing, ties, scarves, necklaces, bracelets etc. Do not destroy any material which might become tangled, such as tapes, binder ties or foil.

**Switch off the shredder and pull out the power plug** before moving or cleaning the shredder, or any other task outside its normal scope of use.

Maintenance and service tasks may only be performed by HSM customer service and service engineers of our dealers.

## 2 Safety instructions



### **Danger:**

It is prohibited to operate one only machine of a combination-version machine. The safety clearances are only guaranteed with the combined document shredder and HSM press.

Ensure that no unauthorised persons can access the document shredder. Do not leave the document shredder switched on when it is unattended. The shredder may not be operated by anyone under 16 years of age.

When the machine is not in use, it must be shut down and secured against unauthorised use. To do so, you can secure the mains switch with a padlock when it is in the off position.

- Read the operating manual before starting up the shredder.
- Do not remove or modify safety devices which guarantee the safe operation of the machine.
- Observe all safety instructions attached to the machine.
- Only open the front door once the machine has come to a standstill.
- Carry out inspection and maintenance regularly.
- Switch off the shredder, disconnect the power plug and call customer service in the following circumstances:
  - Power cables or plugs are damaged
  - Liquid has entered the shredder
  - The shredder has been exposed to rain
  - The machine does not work properly despite the operating manual having been observed
  - The shredder has been damaged
- No platforms or other raised surfaces may be placed near the shredder if they encroach on the specified safety clearances.

## Operating controls for your safety

### Emergency stop switch bar



In the event of danger, press the emergency stop switch bar immediately.

This switches off the shredder, and stops the cutting block and feed belt.

### Main switch (only Solo-version)



In the event of danger, turn the main switch to "0".

You can secure the main switch in this position with a padlock to prevent restarting.

3 Overview



- 1 Main switch
- 2 Safety instructions
- 3 Operating and display elements
- 4 Emergency stop switch bar
- 5 Loading tray
- 6 Intake conveyor
- 7 Braking swivel castors
- 8 Nameplate
- 9 Oil reservoir opening
- 10 Option: Discharge conveyor belt for solo machines

4 Dimensions

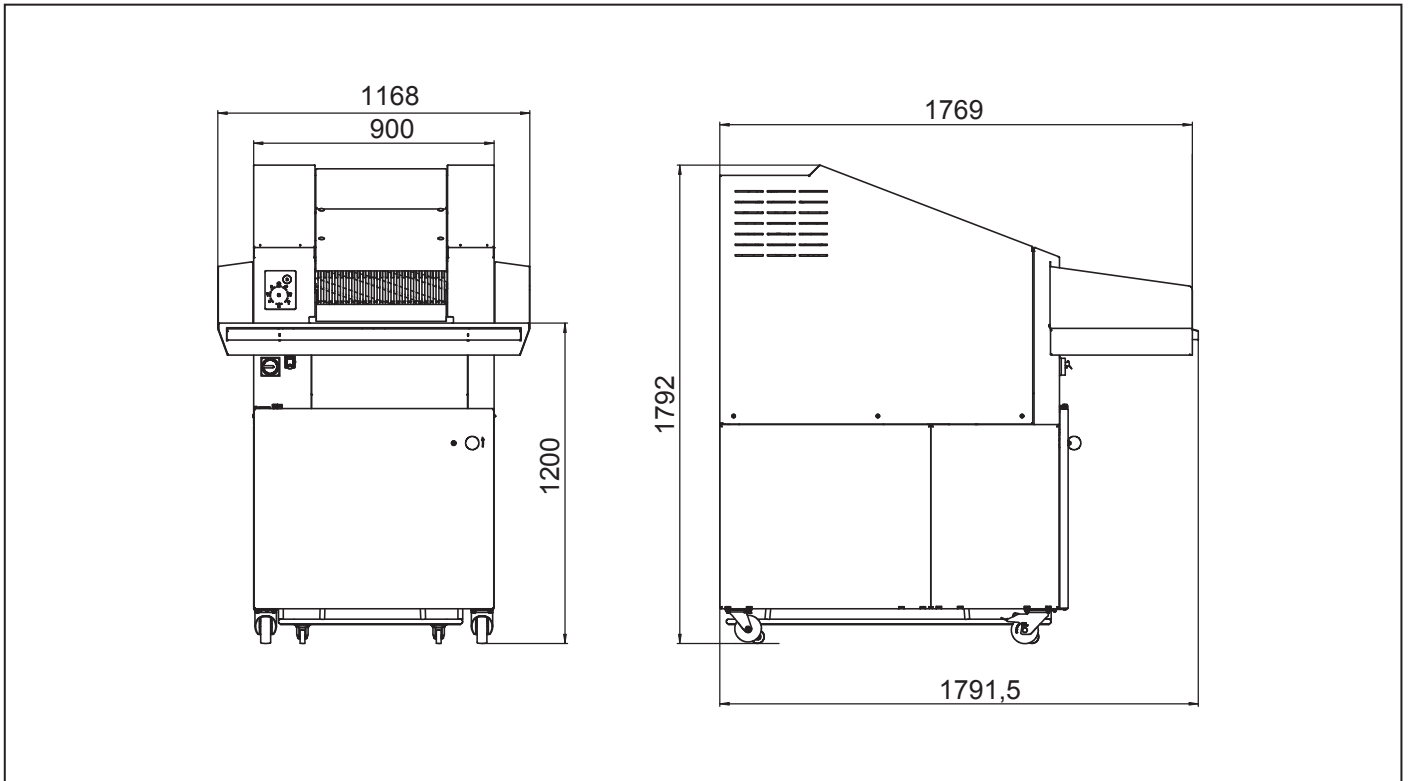

HSM FA 500.3

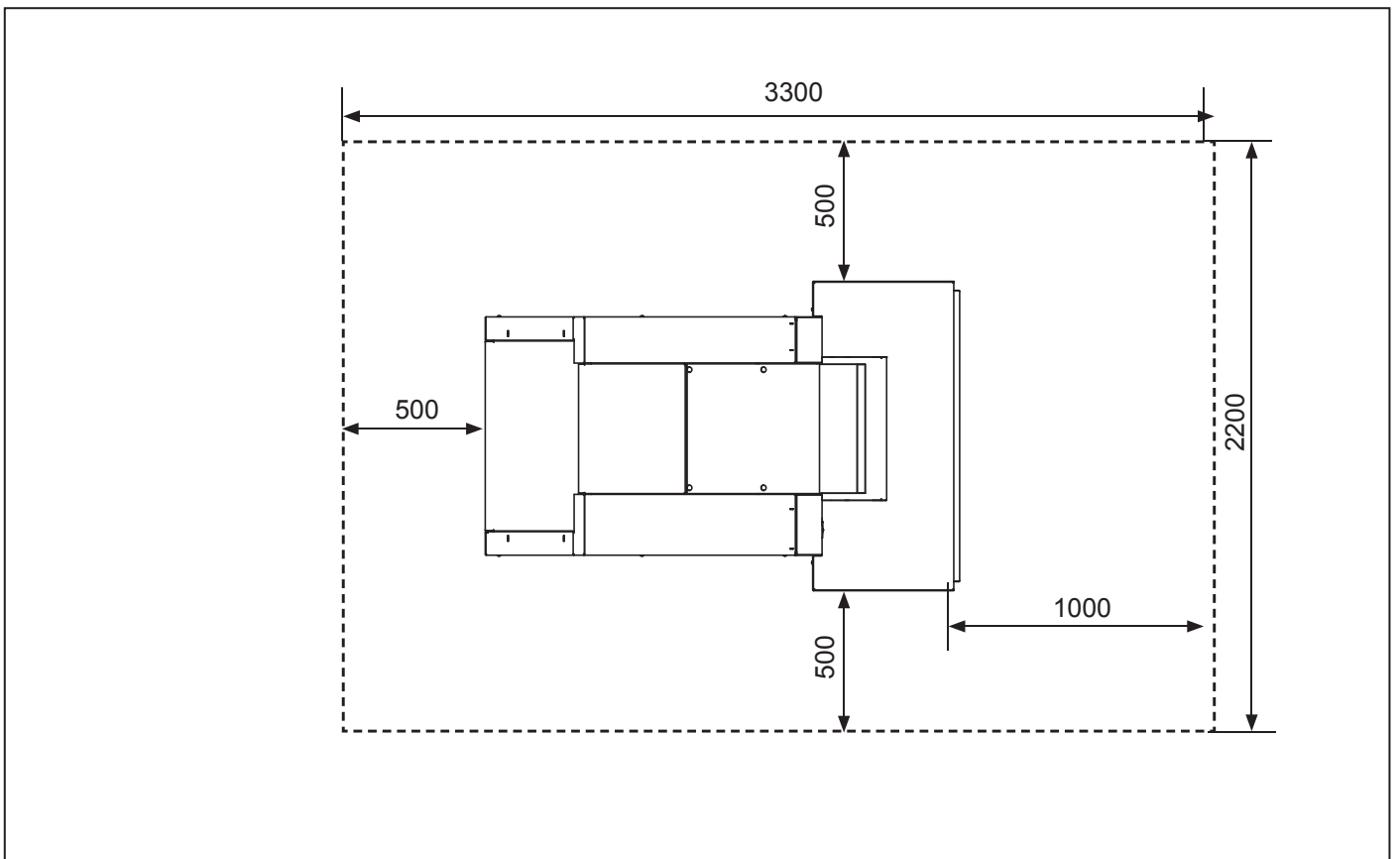

Space requirements for operation and maintenance

## 5 Transportation, installation

- During transport, observe the high centre of gravity of the paper shredder!
- Place the pallet with the shredder in its packaging on a smooth, level surface.
- Observe the instructions for unpacking.
- If you need to move the shredder through narrow doors, you can wait until it is at its final location before fitting the loading tray. Without the tray, the machine is only 900 mm wide.
- The shredder may only be placed in dry rooms on a hard, level floor – not on carpets. The floor load on each roller is approximately 200 kg respectively 230 kg (machines with cutting unit 1.9 x 15 mm).
- The machine must be connected to a power source which meets the specifications on the nameplate. Make sure the power cable is unobstructed and that nobody can tread on it.

- Insert the plug (connection for emergency stop switch bar) into the socket next to the main switch and turn it to stop.



### Mount the loading table onto the unit:

- Attach the table using the M 10 nuts (1)

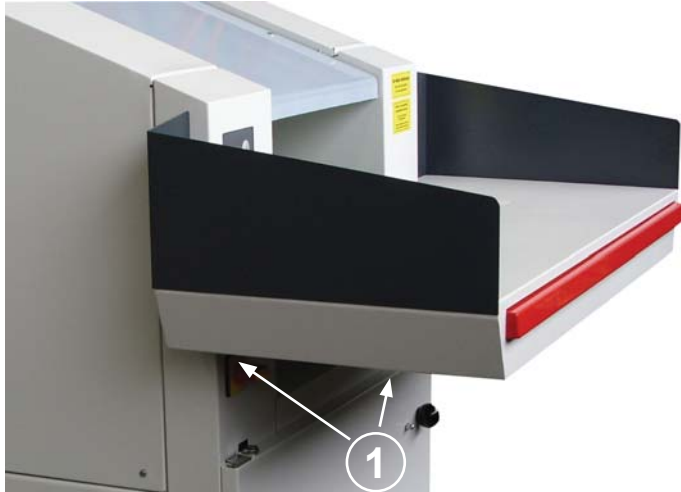

Lock the front castors by pressing down the brake lever.

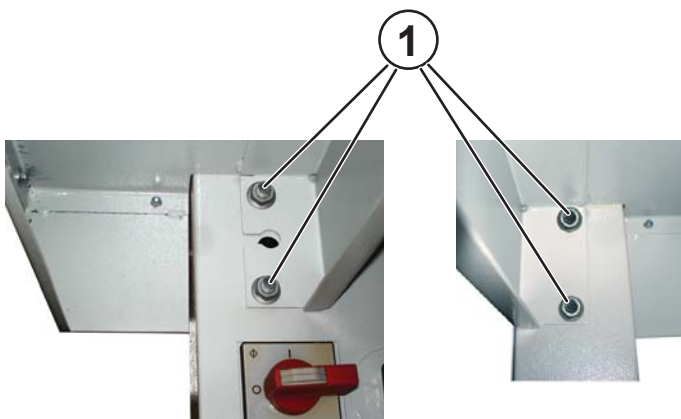

- The mains impedance of the CEE 3x32 A + N + PE connection socket on site must not exceed 0.1517 Ohm. This must be checked by a qualified electrician.
- Insert the machine's power plug into the connection socket.

**Notice:** Extension cables are not permitted.

## Discharge conveyor belt assembly

The solo version of the document shredder is also available with a discharge conveyor belt as an optional extra. If your machine is equipped with one, then the document shredder and the conveyor belt can be combined.

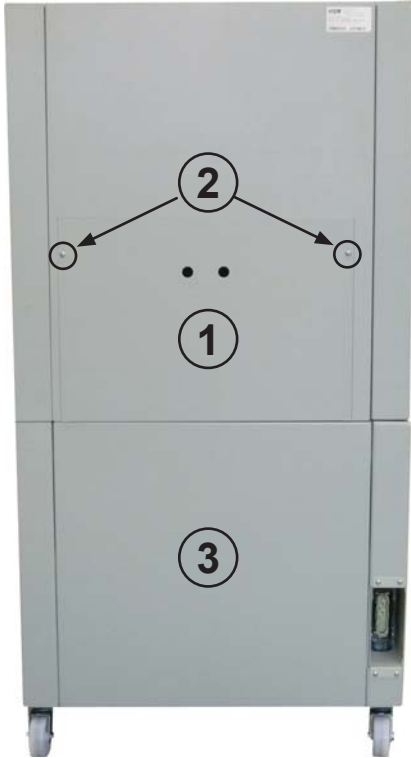

Remove the lid (1) on the rear side of the document shredder. To do this, remove the screws (2).

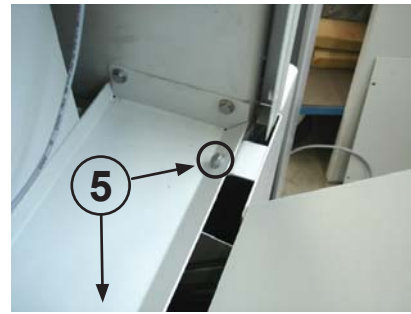

Secure the connection using the screws (5).

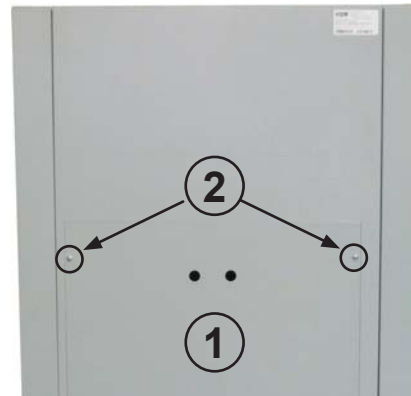

Attach the lid (1) using the screws (2). Connect the power plug of the conveyor belt using the coupling on the rear side of the document shredder.

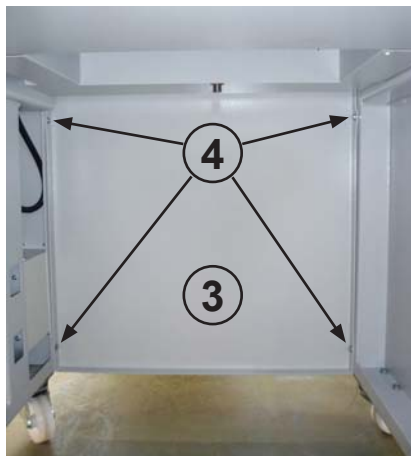

The plate (3) was only installed as a transport lock. Remove the plate by undoing the bolted joints (4). Complete this task from the inside of the document shredder.

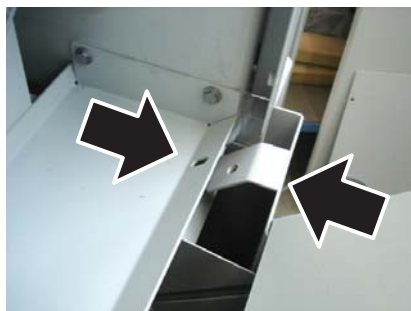

Push the conveyor belt onto the document shredder.

## 6 Operating and display elements

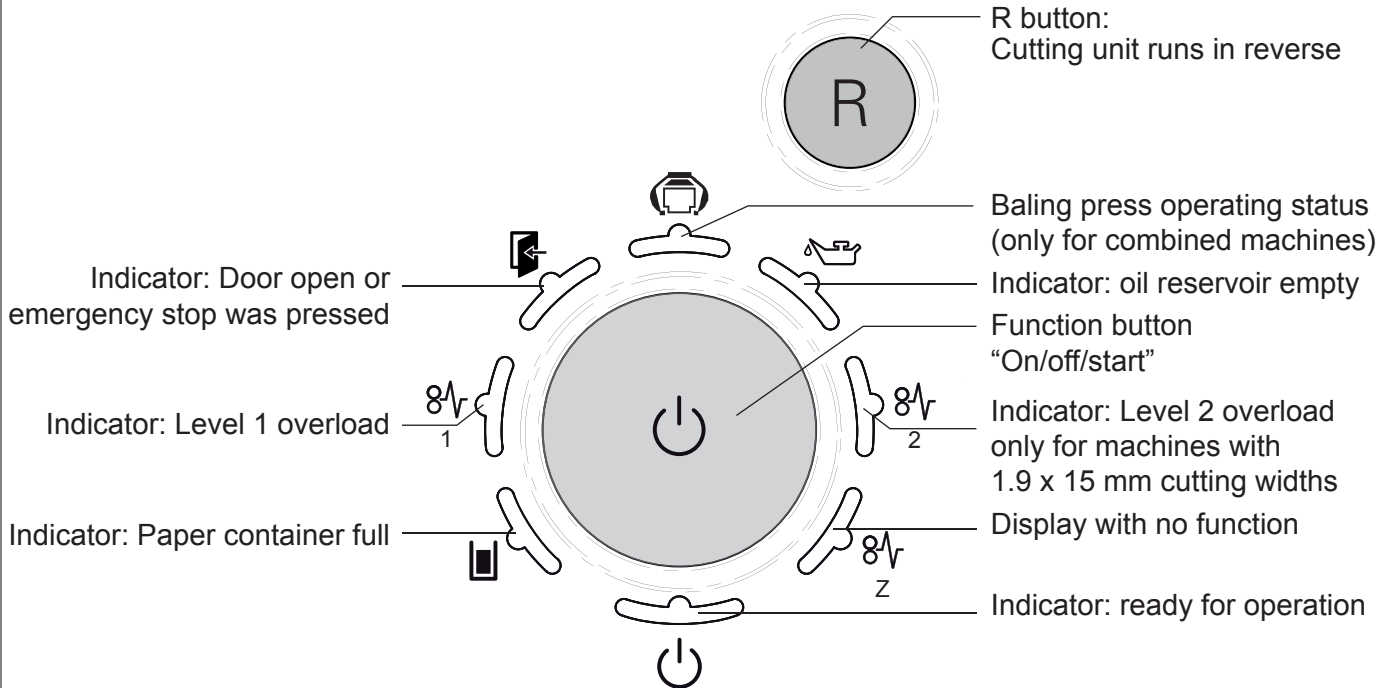

## 7 Start-up

### Attaching the waste bag (Solo version)

- Open the front door and pull out the waste trolley.
- Put in a new waste bag and fold it approximately 20 cm over the top frame tube. When using a two-chamber system, make sure that there is also around 20 cm of plastic foil below the brackets (1).
- Push in the waste trolley and close the front door.

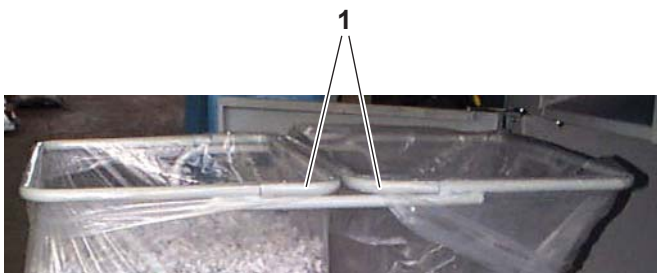

### Inspecting the safety devices



Check that the safety devices are working properly:

- At the start of each shift
- After any maintenance or repair work

Do not start the machine until you have checked the safety devices and found them to be in perfect working order. If any defect arises during operation stop the machine immediately and make sure it is corrected.



### Switching on the paper shredder

- Activate the emergency stop control by pushing the switch bar away from the machine.



- Solo-version: Turn the main switch to the I position.
- Combination-version: Turn the main switch on the baling press to the I position.

- ▶ The indicator „Ready for operation“ lights up.

**Note:**

If an error message lights up (such as “Door open” or “Paper container full”), first rectify the error.



- Press the start button.

- ▶ The cutting block and feed belt start up.



**Caution!**

The feed belt can run in reverse if the phase wires in the power plug are incorrectly connected.

Turn off the main switch immediately and pull out the power plug!

Have an electrician change two of the three phase wires.

### Checking the emergency stop control

- Press the emergency stop switch bar while the machine is running.



- ▶ The shredder must switch off immediately. The cutting block and the feed belt must stop. The machine can only be switched on again once you have pulled out the switch bar.

### Inspecting the door switch

- Open the front door.



- ▶ The indicator “Door open” must light up.
- ▶ The cutting block and feed belt must stop.

After you close the door, the display should go out and you can start the machine again by pressing the start button.

## Shredding material



Place the material to be shredded on the loading tray and then place batches on the feed belt.

If material that is not supposed to be shredded is mistakenly placed onto the belt, never attempt to pull it out



- Press the start button again.
- ▶ The drive stops.



- Press the R-button.
- ▶ The cutting block and feed belt run in reverse.



- You can now remove the material from the belt and start the shredder again by pressing the start button.

**Note:** Provided the cutting unit is running in the shredding direction, you can stop it by pressing the R button.

## Waste bag full



- ▶ The indicator "Paper container full" lights up. The shredder switches off automatically.



- Press the reverse button for approx. 3 seconds.
- ▶ Part of the material is pulled back into the apparatus.
- Open the front door and shake the waste trolley.
- ▶ The cut material spreads in the cut material sack and does not fall into the interior of the shredder.
- Pull the waste trolley out and change the cut material sack.



- Push the trolley back in and start the shredder again by pressing the start button.

## Stopping the shredder



- Press the start button again.
- ▶ The cutting block and feed belt stop.
- ▶ The shredder switches to standby mode.

## Switching off the shredder



- Turn the main switch on the paper shredder or the baling press to 0. You can secure the main switch in this position using a padlock.

## 8 Malfunctions

Check the following before calling customer service:

- Is the power plug connected?
- Is the shredder switched on?
- Is the front door closed?
- Is the waste bag full?
- Is there a paper jam in the shredder?
- Has the motor been overloaded?

### Overload due to paper jam



- ▶ "Overload" display (level 1 or level 2 – depending on the machine model) lights up.
- ▶ The cutting block automatically runs in reverse for several seconds. Then the cutting unit switches off.



#### **Caution!**

*The blade rollers can still cause injuries even while they are not running. Do not reach into the cutting apparatus! Wear safety gloves!*  
Do not alternately press the "Forwards" and "Reverse" buttons to remove the blockage. This will damage the shredder.



- Take out the pile of paper.
- Press the start button and put less paper on the feed belt.

### Electric motor overheated



- ▶ “Overload” display (level 1 or level 2 – depending on the machine model) flashes.
- ▶ The shredder switches off automatically.
- Let the motor cool down for 20 - 30 minutes.
- Press the start button.



### Door open or emergency stop was pressed



- ▶ The indicator lights up.
- ▶ The shredder switches off automatically.
- Close the front door and activate the emergency stop control by pushing the switch bar away from the machine.



- Press the start button.

### Oil reservoir empty



- ▶ “Oil reservoir empty” display lights up.
- Fill the reservoir with cutting apparatus oil. order no. 1.235.997.501 for 5 litre container
- ▶ The “Oil reservoir empty” signal is automatically deactivated after the reservoir is filled.

**Note:** The shredder remains operational even when the oil reservoir is empty.

### Note for machines with 1.9 x 15 mm cutting widths:

Machines with the safety level 4 contain a two-level cutting unit with 2 drives.

After starting the document shredder, level 2 starts initially and about 1 second later level 1 starts in the shredding direction. The drives are separately monitored for possible overload by two rotation sensors. For level 1 overload, the drive is stopped and after a delay of approx. 0.5 seconds is switched into reverse for approx. 3 seconds. Level 2 runs in the shredding direction again.

“Level 1 overload” message with illuminated red LED.

After reversing, the drive remains switched off.

The overload display disappears and the cutting unit starts running in the shredding direction again when the start button is pressed.

If it is not restarted – by pressing the start button – within approx. 5 seconds, then level 2 is also automatically switched off.

For level 2 overload, both drives are switched off and are switched to reverse for approx. 4 seconds firstly for level 1 and then level 2.

Message: red “Level 2 overload” LED.

After reversing, the drives remain switched off.

The overload display disappears and the drives start running in the shredding direction again when the start button is pressed.

#### **Note:**

In some unfortunate circumstances (if the machine has been running for a long time at peak performance), the blockage might not be cleared even if the machine has been re-started and the cutting units must be started up again by pressing the start button.

## 9 Maintenance and care

### Cleaning the shredder:

- Switch off the shredder and disconnect the power plug.
- Only use a soft cloth and mild soapy water for cleaning. Never use scouring agent, cleaning fluid, petroleum or thinners.

### Greasing the drive chains and cogs (twice yearly)

- Switch off the shredder.
- Pull out the power plug.
- Remove the inspection flaps (1) in the left and right side plates. Take out the Allen screws (2).

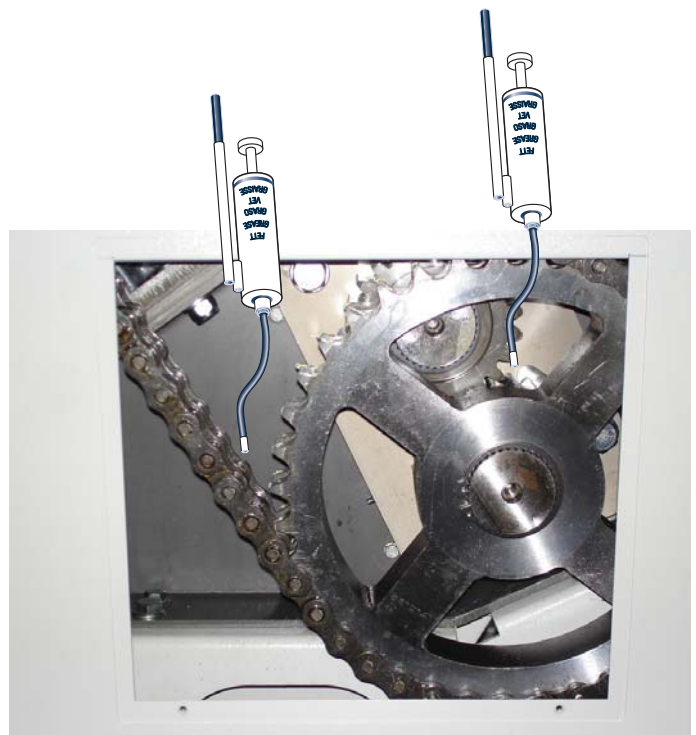

### Dirt drawer on the discharge conveyor belt



Empty the drawer on the discharge conveyor belt regularly if your document shredder is equipped with this type of conveyor belt (optional extra).

- Grease the cogs and the drive chains from the motor to the cutting apparatus, the cutting block to the feed belt and the cutting block to the regulating roller. Recommended lubricating grease: K2K in accordance with DIN 51502/DIN 51825
- Mount the inspection flaps onto the unit again.

## Tightening the feed belt

The feed belt should not slip when loaded with material.

- Switch off the shredder.

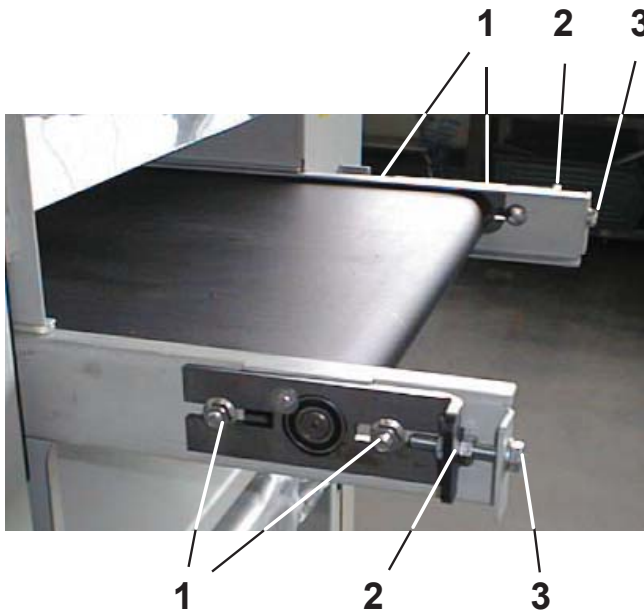

- Loosen the hex nuts (1) on the left and right sides of the snub roller.
- Loosen the lock nuts (2) of the tensioning bolts (3).
- Tighten the feed belt **evenly** using the tensioning bolts.

### Note:

*Only tighten the feed belt until it stops slipping. The feed belt bearing may be damaged if it is tightened too much.*

- Tighten the hex nuts on the snub roller and the lock nuts on the tensioning bolts again.



### You must check that the feed belt runs straight:

Switch on the shredder and let it run for 10 minutes. During this time, the feed belt must run in the middle of the snub roller. If it slips to the left or right edge, you must alter the setting of the snub roller.

## Checking the feed belt for wear

The surface of the feed belt can become worn after long periods of use. If you can see the fabric inlay in the belt, it must be replaced. Please notify our customer service.

## Cleaning the tensioning station (monthly)

- Remove the feeding table and the front panel of the tensioning station.
- Remove particles and dirt.

## Cleaning the conveyor-belt area (monthly)

- Remove the covers on both sides. The cleaning openings in the conveyor-belt covers are now accessible.
- Blow out the conveyor-belt area with compressed air or use a vacuum cleaner to remove the dirt particles.

## 10 Disposal / Recycling

Dispose of the machine in an environmentally sound way at the end of its service life. Observe the current regulations when doing this. As legislation is subject to ongoing changes, we request that you contact your local authorities at the appropriate time. As the manufacturer, HSM would be glad to advise you on the disposal of your old machine.

## 11 Scope of supply, accessories

- Machine on pallet with a wooden frame, strapped with packing tape and packed in foil
- 5 waste bags, order no. 6.205.595.000 (Solo version)
- Special cutting block oil 5 l container with spout, order no. 1.235.997.501
- Operating manual

**12 Technical data**

Cutting type	Cross cut				
Cut size (mm)	10.5 x 40 - 76	7.5 x 40 - 80	6 x 40 - 53	3.9 x 40	1.9 x 15
Safety level DIN 66399	P-2, O-2, T-2, E-2	P-3, O-2, T-3, E-2	P-3, O-2, T-3, E-2	P-4, O-3, T-4, E-3 F-1	P-5, O-4, T-5, E-4, F-2
Cutting capacity (sheets), DIN A4, 70g/m <sup>2</sup> 80g/m <sup>2</sup>	600 - 650 510 - 550	500 - 550 425 - 470	400 - 450 340 - 380	200 - 240 180 - 200	120 - 130 90 - 100
Effective width	500 mm				
Cutting speed	210 mm/s				
Power supply	3 x 400 V, 50 Hz				
Power for the maximum number of sheets	7.5 kW				5.5 + 4 kW)
Nominal current	27 A				31 A
Plug	CEE 3x32 A + N + PE				
Safety fuse Line safety switch Max. mains impedance	Type „gl“ 35 ampere K or C / 32 ampere 0,1517 Ohm				
Ambient conditions in transport, storing and operation: Temperature Relative humidity Height above sea-level (MSL)	-10 °C to +40 °C max. 90 %, without condensation max. 2,000 m				
Dimensions W x D x H (mm)	1170 x 1795 x 1795				
Weight	790 kg				920 kg
Sound pressure level emissions	75 dB(A)				
Volume of the shredded paper container	2 x 265 l				

**EC declaration of conformity**

The manufacturer **HSM GmbH + Co. KG**, Austrasse 1 - 9, D-88699 Frickingen hereby declares that the machine, referred to here as document shredder **HSM FA 500.3** corresponds to the health and safety requirements of the following EC directives listed below due to its conception and design of the version in which it was put into circulation by us:  
 Machinery directive 2006 / 42 / EC                      EMC directive 2004 / 108 / EC

Applied standards and technical specifications:

- EN 55014-1:2006 + A1:2009
- EN 55014-2:1997 + A1:2001 + A2:2008
- EN 62233:2008
- EN 61000-3-11:2000
- EN 61000-3-12:2005
- EN 61000-6-2:2005
- EN 61000-6-3:2007
- EN ISO 12100-1/A1:2009
- EN ISO 12100-2/A1:2009
- EN 61000-4-2:2009
- EN 61000-4-3:2006 + A1:2008 + A2:2010
- EN 61000-4-4:2004 + A1:2010
- EN 61000-4-5:2006
- EN 61000-4-6:2009
- EN 61000-4-8:2010
- EN 61000-4-11:2004
- EN 60204-1:2006 + A1

Authorised representative for the compilation of technical documentation: Rolf Gasteier, HSM GmbH + Co. KG  
 Frickingen, 11.03.2011

Rolf Gasteier - Technical Director