



//BETENACIOUS//TM

2017 WORKBOOK: 34 YEARS OF TENACITY

NOTHING SOLD SEPARATELY.

Enough with the caveats, prefaces, qualifiers, and quid pro quos – right? And don't get us started on “in-app purchases.” We just want to play Pokémon Go in peace. Is that too much to ask? Okay, we're not actually serious on the pocket monster, but really, is it that hard to say what you mean and mean what you say? What happened to one-stop shops, renaissance men, and batteries included? Well, friends, you now hold in your hands evidence that those ideas... those ideals, rather, haven't been put out to pasture just yet.

Since we planted our flag in 1983, we've stood ready and able to meet your needs, handle your business, and keep you and yours in one piece out there on the job. All without the tiny footnotes or pesky fine print* to trip you up; cause that ain't our style. Nope. We're all about a safer day at work. Genuine. Authentic. True. Period.

If, like us, you long for the days when your word was your bond and you didn't have to haggle over rust-proofing, service plans, or paying extra for fries, then you've come to the right place. Here, you won't have to look in a separate aisle to find our determination to innovate; our attention to detail and craft; our execution honed by decades of experience and care; or (dare we say) our stunning good looks. Believe it or not, this whole package comes standard in every box.

Take that mad, mad, mad, mad world.

*gotcha



102.1 FM
K102.1
Top 40



PPE: PROTECTION. PRO

**THREE PRODUCT PILLARS, ONE PURPOSE.
MAKE THE WORKPLACE A BETTERPLACE.™**

Is there anything sadder than Thanksgiving dinner with no cranberry sauce? Maybe the '85 Bears without William 'Refrigerator' Perry? Or, best one yet: Cheers without Mayday Malone? Point is, harmony is only achieved when the parts all fit together. Remove one element and you're left eating dry turkey, my friend. It's in this spirit of harmoniousness that we endeavor to provide you with a sweet song of PPE. These are the three pillars of safety upon which our Tenacious Work Gear® is built. Remove one pillar and the edifice comes crashing down which, you know, would be bad. We strive to provide Protection, increase your Productivity and help you to manage the Elements you face daily in fields, mines, factories, warehouses, towers, and roadways ... We've put these interconnected safety pillars together to form a more perfect union and guarantee that you'll be covered from every angle no matter what your bailiwick may be. You can trust that our years of expertise, drive, and innovation, combined with leading edge technology, will guide you to peak PPE performance. Let's Make the Workplace a Betterplace™.



DUCTIVITY. ELEMENTS.

{ PROVIDE } PROTECTION

PROFLEX® GLOVES

Trades Series	Pgs. 22-27
Dorsal Impact-Reducing Series	Pgs. 28-29
Thermal Series	Pgs. 30-31
Vibration-Reducing Series	Pgs. 32-33
Fire & Rescue Series	Pg. 34

PROFLEX® KNEE PADS

Gel Series	Pgs. 40-42
Standard Series	Pgs. 44-45
Kneeling Pad Series	Pgs. 46-47

PROFLEX® SUPPORTS

Back Support Series	Pgs. 52-53
Wrist Support Series	Pgs. 54-55
Wraps & Sleeves Series	Pgs. 56-57

GLOWEAR® HI-VIS APPAREL

Class 2 Vest Series	Pgs. 62-65
Class 3 & Class E Series	Pgs. 66-67
Shirt Series	Pgs. 68-70
Non-Certified Series	Pg. 71
Foul Weather Series	Pgs. 72-75
Headwear Series	Pgs. 76-77
Accessory Series	Pg. 77

SKULLERZ® EYE PROTECTION

Safety Glasses Series	Pgs. 86-89
Accessory Series	Pgs. 90-91

SKULLERZ® HEAD PROTECTION

Bump Cap Series	Pgs. 94-95
-----------------	------------

{ IMPROVE } PRODUCTIVITY

SQUIDS® LANYARDS & WORKSITE ORGANIZERS

Tethering Solutions	Pgs. 104-105
Tool Attachment Series	Pgs. 106-107
Tool Lanyard Series	Pgs. 108-113
Retractor Series	Pg. 114
Grabber Series	Pgs. 116-117

ARSENAL® GEAR STORAGE

Packs & Duffel Series	Pgs. 122-123
PPE Storage Series	Pgs. 124-125
Fire & EMS Series	Pgs. 126-129
Hoist Bucket Series	Pgs. 130-133

ARSENAL® TOOL STORAGE

Belt & Accessory Series	Pgs. 138-143
Bag & Organizer Series	Pgs. 144-147

{ MANAGE } ELEMENTS

CHILL-ITS® COOLING PRODUCTS

Evaporative Series	Pgs. 156-162
Absorptive Series	Pgs. 164-165
Phase Change Series	Pgs. 166-167
Hydration Series	Pgs. 168-169

SHAX® PORTABLE WORK SHELTERS

Pop-Up Series	Pgs. 172-173
Umbrella Series	Pg. 173
Accessory Series	Pg. 173

N-FERNO® WARMING PRODUCTS

Heated Clothing & Acc. Series	Pgs. 178-179
Thermal Clothing Series	Pgs. 180-181
Thermal Liner Series	Pgs. 182-184
Thermal Balaclava Series	Pgs. 185-187
Thermal Hat & Cap Series	Pgs. 188-189
Thermal Accessory Series	Pgs. 190-191

TREX™ FOOTWEAR ACCESSORIES

Ice Traction Series	Pgs. 194-195
---------------------	--------------

**PARTY IN THE FRONT,
BUSINESS IN THE BACK.**

Reference all the great Ergo product in the front of the book, then learn about Sizing, Index and Warranty info in the back. No kidding and no mullet.

Item Number Index	Pgs. 196-197
Size Charts	Pgs. 198-200
Warranty Info	Pg. 201
Live Tenaciously	Pgs. 202-203

DON'T BE THAT GUY (OR GAL.)

YOU AND THE ERGO WORKBOOK.
A LESSON IN USAGE.

Who doesn't fall for the lovable old crank who proudly owns no cell phone and calls it Tweeter? It's cute. But you don't have to be that guy to appreciate 200+ pages of embossed, glossy goodness designed to get dog-eared. This hot off the presses, glorious guide will help you navigate our product pages better than a GPS on a bluebird day. Less a table of contents, more a table of context. And if you want to be a 21st Century Digital Boy, visit our new website on any device for current company info, fresh social media posts, and the full skinny on all our gear. You won't find this at the library next to the rack of newspapers either. Some things don't belong on a stick.

MODEL NUMBER

If we remember correctly it goes Kingdom, Phylum, Class, Family, Order, Genus, Model Number. Right?

TECH TAGS

Sure, it looks cool. But what does it do? Use our handy tech tag icons and wonder no more.



710_{CR}

ORDER
MULTIPLE
1

HEAVY-DUTY + CUT RESISTANCE



ANSI/ASTM
CUT A4



EN388
3544 D

- Armortex®-backed palm for enhanced cut protection
- Padded palm with Tena-Grip™ reinforcement
- Technical hex-stretch poly-knit construction
- Neoprene knuckle pad
- Low-profile molded hook and loop closure with ID

ITEM #	SIZE	COLOR	ITEM #	SIZE	COLOR
17122	S	Black	17125	XL	Black
17123	M	Black	17126	2XL	Black
17124	L	Black			

// PATENT PENDING

PATENT DESIGNATOR

Thomas Edison had 1,093 of these bad boys.
We're hot on his tail.

ERGODYNE IN PIXELS:

AC/DC, Lithium Ion ... however your device is powered ... know that it longs to use that energy on the Ergo website. Full product info, Tester reviews, video content. It's all here. Oh yes it is. Enjoy.



ERGODYNE IN PRINT:

Here's the long and short of Ergo info presentation in the beloved workbook. Learn it. Live it. Love it.

ORDER MULTIPLE

You're ordering by the case, my friend. Check here for case quantities and minimum order requirements.

PRODUCT NAME

What's in a name? How about trust, reliability, quality, integrity, accountability, notoriety, recognition? Must we go on?

PRODUCT PHOTO

Our gear is ready for its close-up, Mr. DeMille. And we've made sure to get its good side.

SPECIAL SHOUT-OUTS

If a product meets the requirements of ANSI, ASTM, or any other industry standard, we'll display those badges as proudly as a Boy Scout.

FEATURES & BENEFITS

If it can withstand the freeze, block out the sun, or lay golden eggs, we'll let you know about it.

ITEM NUMBERS

Item Numbers – the universal language. Use these to speak our native tongue and get exactly what you need.

ERGODYNE IN THE FIELD:

What good is a product that doesn't go out and get up? Our Tenacious Testers™ are real-world users that evaluate our gear and tell us how they really feel. Look for these sidebars throughout the workbook.

OFFICIAL PRODUCT REVIEW



unscripted • unbiased • unabashed

TESTER: TRAVIS BURKE

PRODUCT: 922CR

"I've been using the 922CR gloves during assembly, test and disassembly of our tools. This testing involved handling parts at elevated temperatures and exposure to oil, grease and water. I've found that with the nitrile dipped palm I am still able to handle smaller parts well and I have a good grip even when the gloves are wet from grease and oil. These gloves are definitely a good product."

ONE WORD REVIEW: GRIP



THE TENACIOUS NATION NEEDS YOU. ENLIST NOW.

Wanna join the corps? We call 'em Tenacious Testers™. Our exclusive field-testing program specifically designed for those who are grinding it out in the trenches each day (desk jockeys and merchandise slingers need not apply). If accepted into our elite and limited tenacious ranks you'll receive product to test – but this ain't no free lunch. Learn more at Ergo.Zone/TTenlist

FRESH SQUEEZED DIGITAL GOODNESS



After a few (dozen) fortnights, our NEW! responsive-design website is live and in living color (a glowing PANTONE 1655 C, natch). Our humble new web home is easy enough for a troglodyte to navigate on any device – read: no more pinch-and-zoom! On www.ergodyne.com, you can get the full scoop on all of our gear, stay hip on all tenacious happenings (check out our blog!), and so much more. Move over, Huff Post, www.ergodyne.com is trending.

GET SOCIAL WITH US

Got Ergodyne FOMO? Follow us and cure what ails you. Don't know what FOMO is? Tweet us and we'll tell you.





CRACK THE CODE.

QUICKLY IDENTIFY THE ATTRIBUTES
THAT MATTER TO A PRODUCT OR RISK.

TECH TAGS

PERFORMANCE AND REGULATORY TAGS

The ancient Egyptians communicated via an intricate system of pictograms known as hieroglyphics. With this system, they wrote histories, conquered many lands, and completed the ultimate pyramid scheme. All while walking sideways! Consider our tech tag system a humble nod to those sun-worshipping ancients. Check the key for all the performance and regulatory characteristics of our Tenacious Work Gear®.

Abrasion Resistant	Acrylic Polymer Crystals	ANSI Compliant	Anti-Stink	Ballistic Material	Break-away Design	Captive Eye
Chemical Free	Computer Storage	CSA Compliant	Cut Resistant	Dorsal Protection	Dry Surface Grip Technology	EN Compliant
ESD / Non-Static	Flame Resistant	Flat Seams	Foreign Materials Management	Hand Washable	Gel Polymer	Genuine Leather Construction
High Visibility	High Dexterity	Impact	Waterproof Membrane	LEDs	Machine Washable	Magnetic
Built with 3M™ Materials	Micro-Fiber	MIL-PRF 32432	Modular Design	Moisture Management	Non-Conductive or ESD	OutDry® Waterproof Membrane
Patented Nu²O₃ Polymer	Patented Open-Center Stay™	P.A.L.S. Design	PVA Cooling Material	Patented Sticky Fingers® Stay	Puncture Resistant	1-Hand Operation
Reflective Accents	Reversible Design	Rubber Base	Soil Release	Stainless Steel	Storm Drains	Swiveling Design
Touch Screen Compatible	Thermal	UV Protection	Water Repellent	Weight Rated	Wet Surface Grip Technology	Wheeled Design

KNOWLEDGE IS (400 HORSE) POWER.

ALL THIS KNOWLEDGE CAN'T BE CONTAINED IN FOUR WALLS.
WE'RE HITTING THE ROAD WITH OUR TAILGATE TALKS™.



Shine up your apples and sharpen your pencils. Our safety train(ing) is full steam ahead. Whether on Planet Orange or on the job, our array of Tenacious U's, webinars, blog posts, and on-site visits will have you speaking fluent safety in no time. Whatever the topic, we're ready to roll up our sleeves and get down to business talking jobsite risks, regulatory wrinkles, and how to put our Tenacious Work Gear® straight to work. Sweeping the country, our Tenacious Assault Vehicle takes the show on the road, dropping knowledge - not to mention jaws - at our Tailgate Talks™. Start taking notes, kids, 'cause this one will be on the test.



TENACIOUS UNIVERSITY:

When it comes to training, we aren't a one trick pony. We supply a full offering to get you and your workers up to speed on a safer way to work. Contact us at tenaciousnation.com to get your own edumakation on the books.

- | | | |
|--------------------------|-----------------|----------------|
| // TAV & TAILGATE TALKS™ | // WEBINARS | |
| // TRAINING VIDEOS | // SITE SURVEYS | // AND MORE... |
| // TENACIOUS BLOG | // DEMO LABS | |

A FRESH COAT OF 'AW YEAH!'

ON THE SALES FLOOR, CLAIM THE SPACE, CONQUER THE BATTLEFIELD!

Is your Doobie Brothers poster sun-bleached? Has the shag carpet lost its luster? Sounds like it's time to spruce up the joint. And we're not talking pine tree air fresheners and new throw pillows. We mean a full-on Orange-ification of the premises in the form of Ergodyne merchandisers. Standees, signage, specialty cases. All new corrugated show room features? You name it. We've got the goods to accompany all of our fine merchandise and get it flying out your doors. So get on the horn and place your orders. Operators are standing by ...

INTERESTED IN THESE DISPLAYS?

Contact orders@ergodyne.com to view the full line of display options and get the skinny on how to get 'em in your store.



99705

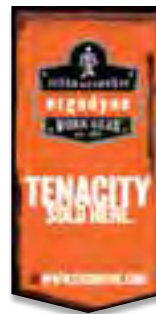

99715



99710



99720

MERCHANDISING BANNERS

"TENACITY SOLD HERE"

Horizontal Banner - Large

- ITEM #99705

Horizontal Banner - Small

- ITEM #99710

Vertical Banner

- ITEM #99715

Authorized Dealer Door Clings

- ITEM #99720 (Packed in Sets of 10)

WATERFALL DISPLAY AND HANGER KIT

(1) WATERFALL AND
(10) HANGERS - KIT

- ITEM #99823

HANGERS ONLY (10)

- ITEM #99821

WATERFALL ONLY (1)

- ITEM #99846



99846

*Requires Slat Wall

CORRUGATED DUMP DISPLAYS

HEAT STRESS
• ITEM #99911

HI-VIS
• ITEM #99913

COLD STRESS
• ITEM #99912



CORRUGATED HUTCH DISPLAYS

HEAT STRESS
• ITEM #99915

HI-VIS
• ITEM #99917

COLD STRESS
• ITEM #99916

GLOVE
• ITEM #99918



CORRUGATED SMALL COUNTER TOP DISPLAYS

HEAT STRESS
• ITEM #99925

GLOVES
• ITEM #99926

EYEWEAR DISPLAYS

12 PAIR LOCKING DISPLAY
• ITEM #99848

7 PAIR NON-LOCKING DISPLAY
• ITEM #99847



99847

99848

SOMETHIN' SPECIAL JUST FOR YOU

Roll out the red orange carpet and call the paparazzi, 'cause Ergodyne's SWAG supply is enough to turn golden Ozzy green with envy. But don't worry, we'll spare you the pencils and pepper spray - only the best for you, beloved safety warrior. If you bleed orange and live tenaciously day in and day out, this stuff is meant for you. But don't hog it all - share it like an ice cold Coke on a warm summer's day, make a friend or three dozen. Pass out the pens, and let the good times roll.

READY TO GET THE SWAG TRAIN ROLLING?

See the full list of Tenacious Goods (and get them for yourself!) on www.ergodyne.com



DIGI CAMO HAT
SIZE: L/XL



BLACK FLEXFIT HAT
SIZE: L/XL



TENACIOUS HITCH COVER
ITEM #90222



ERGO BOTTLED WATER
ITEM #99740 / 24pk.



BORN TENACIOUS ONESIE
SIZES: Infant, 6 mo. 12 mo.



LIGHTWEIGHT MOCK
SIZES: XS-3XL



LIGHTWEIGHT HALF-ZIP
SIZES: XS-3XL



3-PACK GOLF BALLS
ITEM #90217

BEVERAGE EXTRICATION TOOL
ITEM #99805



TENACIOUS PEN
ITEM #90199



AWARENESS MULTI-BANDS
BREAST CANCER - PINK
ITEM #92119
MOVEMBER
ITEM #92112



WHITE CANVAS TOTE
ITEM #90215

DITTY BAG
ITEM #90219



LUGGAGE TAG
ITEM #90216

BARBED WIRE LANYARD
ITEM #90136



PROTEC



TION



PROFLEX®

- » GLOVES
- » KNEE PADS // KNEELING PADS
- » BACK SUPPORTS
- » SUPPORTS // WRAPS // SLEEVES

GLōWEAR®

- » VESTS // SHIRTS
- » FOUL WEATHER GEAR
- » HEADWEAR
- » ACCESSORIES

SKULLERZ®

- » EYE PROTECTION
- » HEAD PROTECTION





TAKE THIS JOB

**PROFLEX®
GLOVES**

AND GLOVE IT.

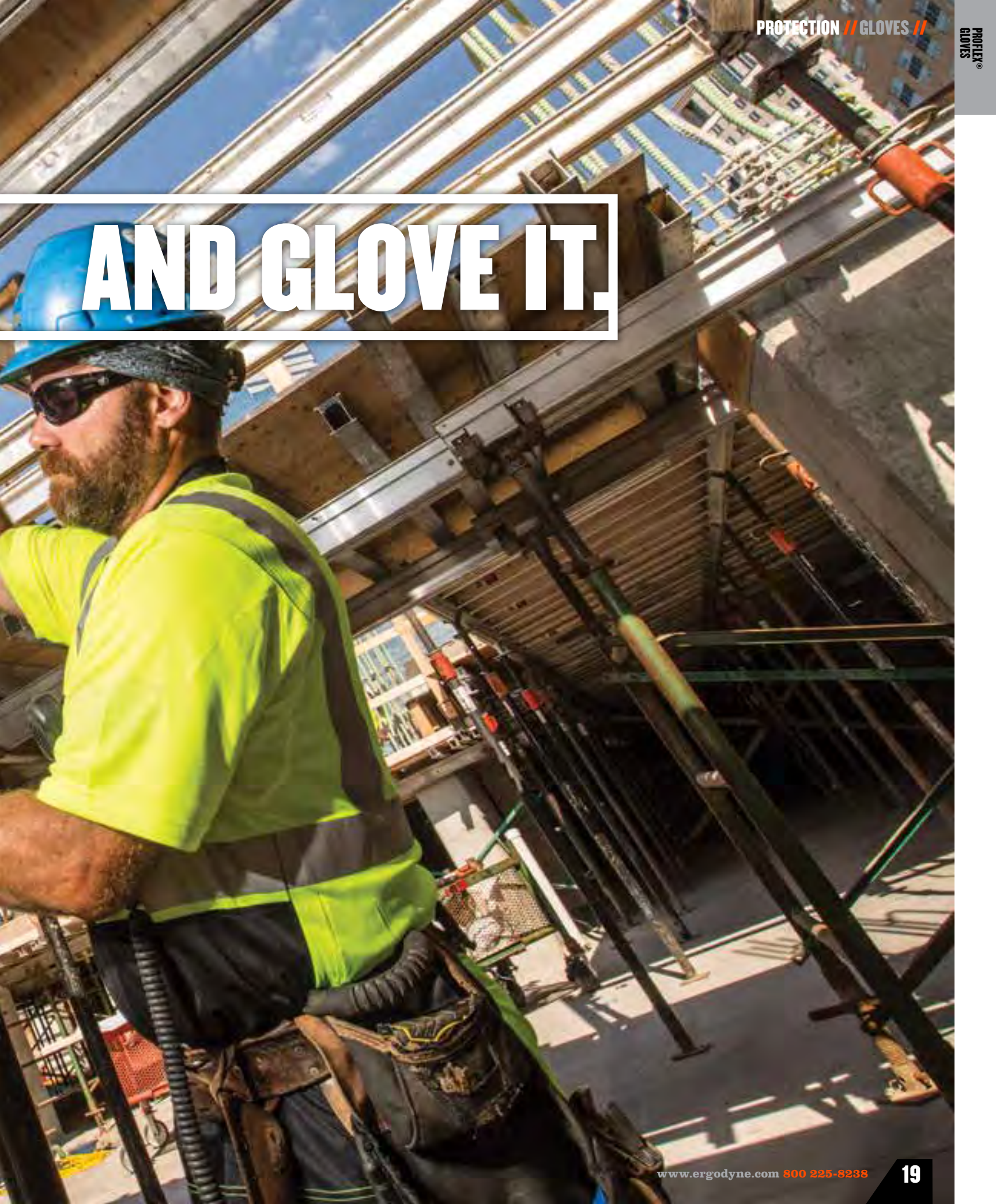



PROFLEX® GLOVES

Thumbs separate us from the animals and help you hitch a ride after you've bounced from a job like Johnny Paycheck. So take care of the digits that dote on you. With ProFlex® Gloves' combination of durability and world-class technological advancements like Armortex®, AX Suede™, OutDry®, and Thinsulate™ – we've got a phalanx of protection for your phalanges. We'd say that deserves a hand, don't you think?

GLOVES // TRADES SERIES



710 Heavy-Duty Utility



710 Hi-Vis Heavy-Duty



710CR Heavy-Duty + Cut



710TX Heavy-Duty + Touch

GLOVES // TRADES SERIES



860 Lifting Utility



811 Hi-Dexterity Utility



812 Utility



812 Hi-Vis Utility

GLOVES // DORSAL IMPACT-REDUCING SERIES



925F(x) Standard



925CR Performance + Cut



925WP Performance + Thermal



924 Hybrid

GLOVES // VIBRATION-REDUCING SERIES



9015 F(x) Certified Dorsal



9002 Certified



9012 Certified w/ Wrist Support



9000 Lightweight Certified

GLOVES // THERMAL SERIES



819WP/OD Waterproof Gauntlet



818WP/HV Waterproof Utility



817/WP Waterproof



816 Thermal Flip-Top





710LTR HD Leather Reinforced



760 Impact-Reducing



820 High Abrasion Handling



720LTR HD Leather Framing



720 Heavy-Duty Framing



812CR Utility + Cut



812TX Utility + Touch



815 QuickCuff™ Utility



810 Reinforced Utility



821 Smooth Surface Handling



920 Nitrile-Dipped



921 Rubber-Dipped Thermal



922CR Cut Resistant Nitrile-Dipped



900 Impact



910 Impact w/ Wrist Support



901 Economy Impact



800 Liner



814 Thermal Utility

**GLOVES
// FIRE & RESCUE
SERIES**



730 Performance



7300D Performance OutDry®



740 Rope

PROFLEX® GLOVES:

TRADES SERIES

DIFFERENTIATED BY DESIGN

RUGGED REINFORCEMENTS

Tena-Grip™ reinforcement zones on palm, thumb saddle, and fingertips resist abrasion and provide superior grip on tools and equipment.

FULL OR FRAMING

Full-finger gloves offer maximum protection while a framing finger configuration combines protection with maximum dexterity for handling fasteners.



PADDED PALM

Premium EVA foam palm pad helps dampen shock and impact.

NEOPRENE KNUCKLE PAD

Padded neoprene knuckle area protects while providing maximum comfort.

TECHNICAL OPTIONS

Choose TX Touch Screen fingertips, enhanced cut protection, or genuine leather zones.

710CR

FIND OUT MORE ABOUT THE TECHNOLOGY THAT GOES INTO THE FULL LINE OF ERGODYNE GLOVES AT: WWW.ERGODYNE.COM

			710			ORDER MULTIPLE 1
HEAVY-DUTY UTILITY						
<ul style="list-style-type: none"> • Padded palm with Tena-Grip™ reinforcement • Tena-Grip™-reinforced fingertips and thumb saddle • Technical hex-stretch poly-knit construction • Neoprene knuckle pad • Low-profile molded hook and loop closure with ID 						
ITEM #	SIZE	COLOR	ITEM #	SIZE	COLOR	
17042	S	Black	17045	XL	Black	
17043	M	Black	17046	2XL	Black	
17044	L	Black				
// PATENT PENDING						

			710			ORDER MULTIPLE 1
HI-VIS HEAVY-DUTY UTILITY						
<ul style="list-style-type: none"> • Padded palm with Tena-Grip™ reinforcement • Tena-Grip™-reinforced fingertips and thumb saddle • Hi-vis hex-stretch polt knit construction with reflective • Neoprene knuckle pad • Low-profile molded hook and loop closure with ID 						
ITEM #	SIZE	COLOR	ITEM #	SIZE	COLOR	
17272	S	HV Lime	17275	XL	HV Lime	
17273	M	HV Lime	17276	2XL	HV Lime	
17274	L	HV Lime				
// PATENT PENDING						

710_{CR}

ORDER MULTIPLE
1

HEAVY-DUTY + CUT RESISTANCE

ANSI/ASTM CUT A4

EN388 3544 D

- Armortex®-backed palm for enhanced cut protection
- Padded palm with Tena-Grip™ reinforcement
- Technical hex-stretch poly-knit construction
- Neoprene knuckle pad
- Low-profile molded hook and loop closure with ID

ITEM #	SIZE	COLOR	ITEM #	SIZE	COLOR
17122	S	Black	17125	XL	Black
17123	M	Black	17126	2XL	Black
17124	L	Black			

// PATENT PENDING

710_{TX}

ORDER MULTIPLE
1

HEAVY-DUTY + TOUCH

EN388 3132

- Touch screen thumb and index finger reinforcement
- Padded palm with Tena-Grip™ reinforcement
- Technical hex-stretch poly-knit construction
- Neoprene knuckle pad
- Low-profile molded hook and loop closure with ID

ITEM #	SIZE	COLOR	ITEM #	SIZE	COLOR
17132	S	Black	17135	XL	Black
17133	M	Black	17136	2XL	Black
17134	L	Black			

// PATENT PENDING

710_{LTR}

ORDER MULTIPLE
1

HEAVY-DUTY LEATHER-REINFORCED

EN388 2122

- Padded palm with durable leather reinforcement
- Leather fingertips, thumb, and thumb saddle
- Technical hex-stretch material construction
- Neoprene knuckle pad
- Low-profile molded hook and loop closure with ID

ITEM #	SIZE	COLOR	ITEM #	SIZE	COLOR
17142	S	Black	17145	XL	Black
17143	M	Black	17146	2XL	Black
17144	L	Black			

// PATENT PENDING

NEW FOR '16 ANSI/ISEA 105-2016 IS THE U.S. STANDARD FOR GLOVE TESTING

NEW ANSI CUT TEST: ASTM F2992-15

TDM (TOMODYNAMOMETER) MACHINE PULLS A BLADE IN 20MM PATHS ACROSS GLOVE SURFACE UNDER VARIOUS GRAM LOADS AND MEASURES THE WEIGHT NEEDED TO CUT THROUGH

ANSI 105 PRE-2016

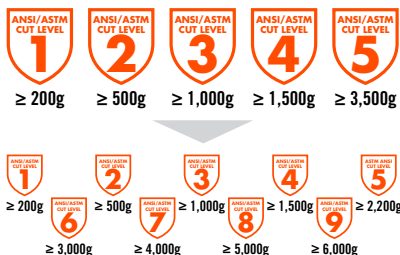

NEW ANSI 105-2016

REVISION IN PROCESS EN 388:2016 IS THE EU STANDARD FOR GLOVE TESTING

EN 388:2016 IS ALSO REFERENCED GLOBALLY (CAN, MEX, AUS/NZ, S. AMERICA)

2016 REVISION WILL SPECIFY **TWO EN CUT TESTS: BLADE CUT & ISO 13997**

START HERE:

EN BLADE CUT: COUPE TESTER MACHINE ROTATING BLADE UNDER A FIXED WEIGHT THAT SPINS ON GLOVE SURFACE UNTIL CUT THROUGH; COMPARES RESULTS TO REFERENCE FABRIC

ISO 13997: TDM MACHINE PULLS A BLADE IN 20MM PATHS ACROSS GLOVE SURFACE AND MEASURES THE FORCE NEEDED TO CUT THROUGH IN NEWTONS

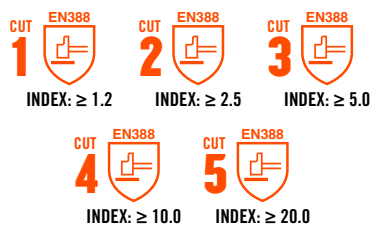

IF GLOVE MATERIAL DULLS COUPE TESTER BLADE, USE ISO 13997 CUT TEST.

ASTM & ISO CUT TESTS NOW ALLOW FOR A MORE ACCURATE COMPARISON.

PROFLEX® GLOVES:

TRADES SERIES

DIFFERENTIATED BY DESIGN

RUGGED REINFORCEMENTS

Tena-Grip™ reinforcement zones on palm, thumb saddle, and fingertips resist abrasion and provide superior grip on tools and equipment.

KNUCKLE-BUSTING IMPACT PROTECTION

Sleek, patent-pending molded thermoplastic rubber (TPR) protects from “knuckle-busting” scrapes and impact while still maintaining high dexterity and flex.

PADDED PALM

EVA padded palm dampens shock and impact while abrasion resistant Tena-Grip™ palm provides superior durability and grip.

MOLDED HOOK & LOOP CLOSURE

Molded TPR closure keeps debris out and glove secure as well as provides a place to write your name or initials.



760



760

ORDER MULTIPLE 1

IMPACT-REDUCING UTILITY



- TPR deflects knuckle busting impacts and scrapes
- Padded palm with Tena-Grip™ reinforcement
- Tena-Grip™-reinforced fingertips and thumb saddle
- Technical hex-strech poly knit construction
- Molded hook and loop closure with ID space

ITEM #	SIZE	COLOR	ITEM #	SIZE	COLOR
17662	S	Black	17665	XL	Black
17663	M	Black	17666	2XL	Black
17664	L	Black			

// PATENT PENDING



820

ORDER MULTIPLE 1

HIGH-ABRASION HANDLING



- Abrasion resistant Tena-Grip™ palm and fingers
- Tena-Grip™-reinforced thumb saddle
- Technical hex-strech poly-knit construction
- Neoprene knuckle pad
- Low-profile molded hook and loop closure with ID

ITEM #	SIZE	COLOR	ITEM #	SIZE	COLOR
17242	S	Black	17245	XL	Black
17243	M	Black	17246	2XL	Black
17244	L	Black			

// PATENT PENDING



FIND OUT MORE ABOUT THE TECHNOLOGY THAT GOES INTO THE FULL LINE OF ERGODYNE GLOVES AT: WWW.ERGODYNE.COM

720

ORDER MULTIPLE
1

HEAVY-DUTY LEATHER-REINFORCED FRAMING

EN388
2122

- Framing finger config for grasping fasteners
- Padded palm with durable leather reinforcement
- Technical hex-stretch poly-knit construction
- Neoprene knuckle pad
- Low-profile molded hook and loop closure with ID

ITEM #	SIZE	COLOR	ITEM #	SIZE	COLOR
17152	S	Black	17155	XL	Black
17153	M	Black	17156	2XL	Black
17154	L	Black			

// PATENT PENDING

720

ORDER MULTIPLE
1

HEAVY-DUTY FRAMING

EN388
3132

- Framing finger config for grasping fasteners
- Padded palm with Tena-Grip™ reinforcement
- Technical hex-stretch poly-knit construction
- Neoprene knuckle pad
- Low-profile molded hook and loop closure with ID

ITEM #	SIZE	COLOR	ITEM #	SIZE	COLOR
17112	S	Black	17115	XL	Black
17113	M	Black	17116	2XL	Black
17114	L	Black			

// PATENT PENDING

860

ORDER MULTIPLE
1

HEAVY-LIFTING UTILITY

EN388
COMING
SOON

- Half-finger design for maximum dexterity
- Padded leather palm with reinforced thumb saddle
- Breathable stretch spandex construction
- Neoprene knuckle pad and thumb brow wipe
- Molded hook and loop closure with ID space

UPDATED FOR
'17

ITEM #	SIZE	COLOR	ITEM #	SIZE	COLOR
17282	S	Black	17285	XL	Black
17283	M	Black	17286	2XL	Black
17284	L	Black			

PROFLEX®
TRADES GLOVES:
STANDARD AND "+"

All ProFlex® Trades Gloves are designed to perform and built to last. But sometimes, the job requires that little extra somethin' to help handle your specific hazard. Technical adds like + Touch Screen and + Cut Resistance are found across the line with a color-coded system to show you the way.

ProFlex® Trades Gloves are tested to the world's most exacting glove standards. All models are CE marked and tested to EN 388 for mechanical risks. Gloves featuring + Cut Resistance are also tested and classified according to ANSI/ISEA 105.

STANDARD TRADES

The tried-and-true originals. Choose a Standard Utility or Heavy-Duty option, full-finger or framing config. Look for orange accents and know you've got the best of the basics.

MODELS:
710 // 720 // 760 // 810 // 812 // 815 // 820 // 821 // 860 //

+HI-DEX

It's all about control and feel with this glove. A super-thin (50% thinner than Standard) yet durable, abrasion resistant palm provides maximum dexterity. Look for yellow accents when no job is too tall or too small.

MODELS:
811 //

+TOUCH SCREEN

In today's workplace, the touch screen device has become another tool of the trade. Touch screen-capable palms and fingertips allow you swipe, tap, and type while staying protected. Look for green accents and you're money ... Silicon Valley money.

MODELS:
710TX // 812TX //

+CUT RESISTANCE

When sharp edges and cut hazards crank up the intensity level, turn to ProFlex® Trades Gloves. Armortex®-backed palms with or without reinforcements provide protection in the toughest applications. Look for red accents for no red accidents.

MODELS:
710CR // 812CR //

+GENUINE LEATHER

Want a softer, natural feel without sacrificing protection? ProFlex® Trades Gloves with genuine leather deliver all the features of their standard counterparts but with supple genuine leather reinforcements. Look for tan accents for an old-school look that still packs a punch.

MODELS:
710LTR // 720LTR //

PROFLEX® GLOVES:

TRADES SERIES

DIFFERENTIATED BY DESIGN

MAXIMUM DEXTERITY

Designed for flex and feel, high dexterity comes standard or choose the super Hi-Dex for maximum tactility.



BREATHABLE MESH

Comfortable, breathable mesh construction provides excellent dexterity and flexibility.

TECHNICAL OPTIONS

Choose TX touch screen capability, enhanced cut protection, or an out-of-this-world smooth surface gripping option.

812

SECURE FIT

Low-profile molded closure keeps gloves secure; QuickCuff™ option provides easy on/off.



FIND OUT MORE ABOUT THE TECHNOLOGY THAT GOES INTO THE FULL LINE OF ERGODYNE GLOVES AT: WWW.ERGODYNE.COM

			811			ORDER MULTIPLE 1
HI-DEXTERITY UTILITY						
<ul style="list-style-type: none"> • Super-thin 0.5mm high dexterity gripping palm • Wrapped index finger for maximum feel • Breathable poly mesh construction • Low-profile molded hook and loop closure with ID • Pull-on tab for easy on/off 						
ITEM #	SIZE	COLOR	ITEM #	SIZE	COLOR	
17162	S	Black	17165	XL	Black	
17163	M	Black	17166	2XL	Black	
17164	L	Black				
// PATENT PENDING						

			812			ORDER MULTIPLE 1
UTILITY						
<ul style="list-style-type: none"> • Durable synthetic leather palm • Reinforced thumb saddle wear area • Breathable poly mesh construction • Low-profile molded hook and loop closure with ID • Pull-on tab for easy on/off 						
ITEM #	SIZE	COLOR	ITEM #	SIZE	COLOR	
17172	S	Black	17175	XL	Black	
17173	M	Black	17176	2XL	Black	
17174	L	Black				
// PATENT PENDING						

812

ORDER
MULTIPLE
1

HI-VIS UTILITY

NEW FOR
'17

**EN388
2121**

- Durable synthetic leather palm
- Reinforced thumb saddle wear area
- Breathable hi-vis poly mesh construction
- Low-profile molded hook and loop closure with ID
- Pull-on tab for easy on/off

ITEM #	SIZE	COLOR	ITEM #	SIZE	COLOR
17262	S	HV Lime	17265	XL	HV Lime
17263	M	HV Lime	17266	2XL	HV Lime
17264	L	HV Lime			

// PATENT PENDING

812^{CR}

ORDER
MULTIPLE
1

UTILITY + CUT RESISTANCE

**ANSI/ASTM
CUT A3**

**EN388
3543 C**

- Armortex®-backed palm for enhanced cut protection
- Reinforced thumb saddle wear area
- Breathable poly mesh construction
- Low-profile molded hook and loop closure with ID
- Pull-on tab for easy on/off

ITEM #	SIZE	COLOR	ITEM #	SIZE	COLOR
17182	S	Black	17185	XL	Black
17183	M	Black	17186	2XL	Black
17184	L	Black			

// PATENT PENDING

812^{TX}

ORDER
MULTIPLE
1

UTILITY + TOUCH

**EN388
2121**

- Touch screen capable palm
- Reinforced thumb saddle wear area
- Breathable poly mesh construction
- Low-profile molded hook and loop closure with ID
- Pull-on tab for easy on/off

ITEM #	SIZE	COLOR	ITEM #	SIZE	COLOR
17192	S	Black	17195	XL	Black
17193	M	Black	17196	2XL	Black
17194	L	Black			

// PATENT PENDING

815

ORDER
MULTIPLE
1

QUICKCUFF™ UTILITY

**EN388
2121**

- Durable synthetic leather palm
- Reinforced thumb saddle wear area
- Breathable poly mesh construction
- QuickCuff™ elastic gauntlet fit with ID
- Pull-on tab for easy on/off

ITEM #	SIZE	COLOR	ITEM #	SIZE	COLOR
17202	S	Black	17205	XL	Black
17203	M	Black	17206	2XL	Black
17204	L	Black			

// PATENT PENDING

810

ORDER
MULTIPLE
1

REINFORCED UTILITY

**EN388
3121**

- Ultra-durable AX Suede™ palm reinforcement
- AX Suede™-reinforced thumb saddle wear area
- Breathable poly mesh construction
- Low-profile molded hook and loop closure with ID
- Pull-on tab for easy on/off

ITEM #	SIZE	COLOR	ITEM #	SIZE	COLOR
17222	S	Black	17225	XL	Black
17223	M	Black	17226	2XL	Black
17224	L	Black			

// PATENT PENDING

821

ORDER
MULTIPLE
1

SMOOTH SURFACE HANDLING

**EN388
2131**

- Hex silicone palm pattern for super-tacky grip
- Wrapped index finger for enhanced control
- Breathable poly mesh construction
- Low-profile molded hook and loop closure with ID
- Pull-on tab for easy on/off

ITEM #	SIZE	COLOR	ITEM #	SIZE	COLOR
17232	S	Black	17235	XL	Black
17233	M	Black	17236	2XL	Black
17234	L	Black			

// PATENT PENDING

PROFLEX® GLOVES:

DORSAL IMPACT-REDUCING SERIES

DIFFERENTIATED BY DESIGN

MAXIMUM IMPACT PROTECTION

All new, patent-pending protection scheme combines full-coverage thermoplastic rubber (TPR) armor with segmented foam padding for complete protection.

SUPERIOR DEXTERITY

Strategically located flex grooves within armor and foam ensure protective gloves also provide the dexterity and hand function needed to remain worn during detail work.

DURABLE GRIPPING PALMS

Choose abrasion-resistant AX Suede™ dot gripping material with Armortex® reinforcement, rugged Tena-Grip™ or a specialized dual-layer, flexible winter gripping palm configuration.

CUT PROTECTION

Choose a fully Armortex®-backed dot gripping palm (EN Blade Cut 5; ANSI/ASTM A3) or cut-resistant knit option for enhanced protection in the toughest applications.



925F(x)



FIND OUT MORE ABOUT THE TECHNOLOGY THAT GOES INTO THE FULL LINE OF ERGODYNE GLOVES AT: WWW.ERGODYNE.COM

925_{F(x)}

ORDER MULTIPLE
1

STANDARD DORSAL IMPACT-REDUCING

EN388
COMING
SOON

- Full TPR armor + technical foam for max protection
- Hi-Vis AX Suede™ + non-slip dot gripping palm
- Armortex®-reinforced thumb saddle and index finger
- Hi-vis breathable mesh construction
- Padded neoprene cuff with reflective binding

ITEM #	SIZE	COLOR	ITEM #	SIZE	COLOR
17902	S	HV Lime	17905	XL	HV Lime
17903	M	HV Lime	17906	2XL	HV Lime
17904	L	HV Lime			

// PATENT PENDING

925_{CR}

ORDER MULTIPLE
1

PERFORMANCE DIR + CUT RESISTANCE

EN388
COMING
SOON

ANSI/ASTM CUT A3

- Armortex®-backed palm for enhanced cut protection
- Full TPR armor + technical foam for max protection
- Hi-Vis AX Suede™ + non-slip dot gripping palm
- Armortex®-reinforced thumb saddle and index finger
- Padded neoprene cuff with reflective binding

ITEM #	SIZE	COLOR	ITEM #	SIZE	COLOR
18002	S	HV Lime	17805	XL	HV Lime
18003	M	HV Lime	17806	2XL	HV Lime
18004	L	HV Lime			

// PATENT PENDING

925_{WP}

ORDER
MULTIPLE
1

PERFORMANCE DIR + THERMAL WP

**EN388
COMING
SOON**

NEW FOR

'17

COLD

- Dual-zone 3M™ Thinsulate™ Insulation
- Waterproof/windproof breathable membrane insert
- Full TPR armor + technical foam for max protection
- Dual-layer AX Suede™-reinforced gripping palm
- Armortex®-reinforced thumb saddle and index finger

ITEM #	SIZE	COLOR	ITEM #	SIZE	COLOR
18102	S	HV Lime	18105	XL	HV Lime
18103	M	HV Lime	18106	2XL	HV Lime
18104	L	HV Lime			

// PATENT PENDING

924

ORDER
MULTIPLE
1

HYBRID DORSAL IMPACT-REDUCING

**EN388
COMING
SOON**

NEW FOR

'17

- Full finger TPR + flexible foam knuckle padding
- Padded palm with Tena-Grip™ reinforcement
- Hi-vis fingertips and reinforced thumb saddle
- Hi-vis breathable mesh construction
- Neoprene cuff; hook and loop closure with ID

ITEM #	SIZE	COLOR	ITEM #	SIZE	COLOR
17682	S	HV Lime	17685	XL	HV Lime
17683	M	HV Lime	17686	2XL	HV Lime
17684	L	HV Lime			

// PATENT PENDING

OFFICIAL PRODUCT REVIEW

unscripted • unbiased • unabashed

TESTER: TRAVIS BURKE

PRODUCT: 922CR

“I’ve been using the 922CR gloves during assembly, test and disassembly of our tools. This testing involved handling parts at elevated temperatures and exposure to oil, grease and water. I’ve found that with the nitrile dipped palm I am still able to handle smaller parts well and I have a good grip even when the gloves are wet from grease and oil. These gloves are definitely a good product.”

ONE WORD REVIEW: GRIP

920

ORDER
MULTIPLE
12

NITRILE DIPPED DORSAL IMPACT-REDUCING

**EN388
4121**

- Molded TPR armor for full dorsal impact protection
- Patented “flex zones” reduce hand fatigue
- Abrasion-resistant foam nitrile gripping palm
- Breathable 10-gauge poly/cotton seamless knit
- Hi-vis for hand safety awareness and signaling

ITEM #	SIZE	COLOR	ITEM #	SIZE	COLOR
17002	S	HV Lime	17005	XL	HV Lime
17003	M	HV Lime	17006	2XL	HV Lime
17004	L	HV Lime			

// PATENTED

921

ORDER
MULTIPLE
12

THERMAL RUBBER-DIPPED DIR

**EN388
2242**

- Molded TPR armor for full dorsal impact protection
- Patented “flex zones” reduce hand fatigue
- Foam rubber gripping palm stays flexible in cold
- Thermal acrylic fleece seamless knit
- Hi-vis for hand safety awareness and signaling

ITEM #	SIZE	COLOR	ITEM #	SIZE	COLOR
17012	S	HV Lime	17015	XL	HV Lime
17013	M	HV Lime	17016	2XL	HV Lime
17014	L	HV Lime			

// PATENTED

922_{CR}

ORDER
MULTIPLE
12

CUT RESISTANT NITRILE-DIPPED DIR

**EN388
4543**

- 13-gauge HPPE knit for enhanced cut protection
- Molded TPR armor for full dorsal impact protection
- Patented “flex zones” reduce hand fatigue
- Reinforced sandy foam nitrile gripping palm
- Hi-vis for hand safety awareness and signaling

ITEM #	SIZE	COLOR	ITEM #	SIZE	COLOR
17092	S	Gray	17095	XL	Gray
17093	M	Gray	17096	2XL	Gray
17094	L	Gray			

// PATENTED

PROFLEX® GLOVES:

THERMAL SERIES

DIFFERENTIATED BY DESIGN

TOUCHSCREEN-CAPABLE

All Thermal Series Gloves feature touchscreen-capable thumb and index finger reinforcements.

REFLECTIVE ACCENTS

Stay visible in the dark winter months with reflective back-of-hand accents.

THUMB WIPE

Super-soft thumb zone comfortably wipes sweaty brows and runny noses.

DUAL-ZONE 3M™ THINSULATE™ INSULATION

Nearly 15% warmer than previous versions, most ProFlex® Thermal Series Gloves utilize 70g lofted 3M™ Thinsulate™ Insulation on the back of the hand for extra warmth and 40g on the palm to maintain dexterity.



819WP

WATERPROOF TECHNOLOGY

Many Thermal Series Gloves feature a breathable waterproof, windproof insert or choose revolutionary OutDry® bonded membrane technology.



819.00

ORDER MULTIPLE 1

EXTREME THERMAL WATERPROOF + OUTDRY®



EN388 COMING SOON

- Dual-zone 3M™ Thinsulate™ Insulation
- OutDry® waterproof/windproof bonded membrane
- Weather-resistant ripstop outer shell + DWR finish
- Gauntlet cuff with internal elastic cinch cord
- Rugged AX Suede™ palm + touch screen capabilities

ITEM #	SIZE	COLOR	ITEM #	SIZE	COLOR
17412	S	Black	17415	XL	Black
17413	M	Black	17416	2XL	Black
17414	L	Black			

// PATENT PENDING



819.WP

ORDER MULTIPLE 1

EXTREME THERMAL WATERPROOF UTILITY



EN388 COMING SOON

- Dual-zone 3M™ Thinsulate™ Insulation
- Waterproof/windproof breathable membrane insert
- Weather-resistant ripstop outer shell + DWR finish
- Gauntlet cuff with internal elastic cinch cord
- Rugged AX Suede™ palm + touch screen capabilities

ITEM #	SIZE	COLOR	ITEM #	SIZE	COLOR
17402	S	Black	17405	XL	Black
17403	M	Black	17406	2XL	Black
17404	L	Black			

// PATENT PENDING



FIND OUT MORE ABOUT THE TECHNOLOGY THAT GOES INTO THE FULL LINE OF ERGODYNE GLOVES AT: WWW.ERGODYNE.COM

818_{WP}

ORDER MULTIPLE
1

PERFORMANCE THERMAL WATERPROOF UTILITY

**EN388
COMING
SOON**

- Dual-zone 3M™ Thinsulate™ Insulation
- Waterproof/windproof breathable membrane insert
- Weather-resistant ripstop outer shell + DWR finish
- Tough Tena-Grip™ palm + touch screen capabilities
- Extended neoprene cuff with hook & loop closure

ITEM #	SIZE	COLOR	ITEM #	SIZE	COLOR
17382	S	Black	17385	XL	Black
17383	M	Black	17386	2XL	Black
17384	L	Black			

// PATENT PENDING

817_{WP}

ORDER MULTIPLE
1

REINFORCED THERMAL WATERPROOF UTILITY

**EN388
COMING
SOON**

- Dual-zone 3M™ Thinsulate™ Insulation
- Waterproof/windproof breathable membrane insert
- Weather-resistant ripstop outer shell + DWR finish
- Rugged AX Suede™ palm + touch screen capabilities
- Extended neoprene cuff with hook & loop closure

ITEM #	SIZE	COLOR	ITEM #	SIZE	COLOR
17372	S	Black	17375	XL	Black
17373	M	Black	17376	2XL	Black
17374	L	Black			

// PATENT PENDING

816

ORDER MULTIPLE
1

THERMAL FLIP-TOP

**EN388
COMING
SOON**

- Fleece-lined mitten converts to half-finger gloves
- Mitten pocket and thumb stow easily when not in use
- Weather-resistant outer shell
- Durable synthetic leather palm
- Contoured gathered elastic cuff w/ ID space

ITEM #	SIZE	COLOR	ITEM #	SIZE	COLOR
17342	S	Black	17345	XL	Black
17343	M	Black	17346	2XL	Black
17344	L	Black			

// PATENT PENDING

818_{WP}

ORDER MULTIPLE
1

PERFORMANCE HI-VIS THERMAL WATERPROOF

**EN388
COMING
SOON**

- Dual-zone 3M™ Thinsulate™ Insulation
- Waterproof/windproof breathable membrane insert
- Weather-resistant hi-vis ripstop shell + DWR finish
- Hi-vis Tena-Grip™ palm + touch screen capabilities
- Extended neoprene cuff with hook & loop closure

ITEM #	SIZE	COLOR	ITEM #	SIZE	COLOR
17392	S	HV Orange	17395	XL	HV Orange
17393	M	HV Orange	17396	2XL	HV Orange
17394	L	HV Orange			

// PATENT PENDING

817

ORDER MULTIPLE
1

REINFORCED THERMAL UTILITY

**EN388
COMING
SOON**

- Dual-zone 3M™ Thinsulate™ Insulation
- Weather-resistant ripstop outer shell + DWR finish
- Rugged AX Suede™ palm and fingertip reinforcements
- Touch screen capable thumb and index finger
- Extended neoprene cuff with hook & loop closure

ITEM #	SIZE	COLOR	ITEM #	SIZE	COLOR
17352	S	Black	17355	XL	Black
17353	M	Black	17356	2XL	Black
17354	L	Black			

// PATENT PENDING

814

ORDER MULTIPLE
1

THERMAL UTILITY

**EN388
COMING
SOON**

- Insulated fill for cool to cold temps
- Weather-resistant outer shell
- Durable synthetic leather palm
- Touch screen capable thumb and index finger
- Quick Cuff™ neoprene/elastic gauntlet fit with ID

ITEM #	SIZE	COLOR	ITEM #	SIZE	COLOR
17332	S	Black	17335	XL	Black
17333	M	Black	17336	2XL	Black
17334	L	Black			

// PATENT PENDING

PROFLEX® GLOVES:

VIBRATION-REDUCING SERIES

DIFFERENTIATED BY DESIGN

CERTIFIED PROTECTION

Choose from four ANSI/ISO-certified gloves for maximum protection from harmful vibration and impact.

GEL PALM

Patented 3-layer Nu²O₂ gel or visco-elastic gel polymer palm reduces vibration and dampens shock and impact.

OPEN-CENTER STAY™

Built-in patented Open-Center Stay™ options provide additional support and relief from repetitive motion discomfort.

PIGSKIN LEATHER CONSTRUCTION

Durable pigskin leather palm construction built to stand up to the toughest applications.

NEOPRENE KNUCKLE PAD

Padded neoprene knuckle area protects while providing maximum comfort.



9012



FIND OUT MORE ABOUT THE TECHNOLOGY THAT GOES INTO THE FULL LINE OF ERGODYNE GLOVES AT: WWW.ERGODYNE.COM

			9015 _{F(x)}			ORDER MULTIPLE 1
CERTIFIED AV W/ DORSAL PROTECTION						
<ul style="list-style-type: none"> • ANSI S2.73/ISO 10819-certified AV protection • Patented Nu²O₂ gel polymer palm pad • Abrasion-resistant pigskin leather palm • Molded TPR armor provides dorsal protection • Low-profile hook and loop closure with pull-on tab 						
ITEM #	SIZE	COLOR	ITEM #	SIZE	COLOR	
16232	S	Black	16235	XL	Black	
16233	M	Black	16236	2XL	Black	
16234	L	Black				
// PATENTED						

			900			ORDER MULTIPLE 1
IMPACT GLOVES						
<ul style="list-style-type: none"> • Gel polymer palm pads dampen shock and impact • Abrasion-resistant pigskin leather palm • Half-finger design for optimal dexterity • Neoprene knuckle pad • Low-profile hook and loop closure with pull-on tab 						
ITEM #	SIZE	COLOR	ITEM #	SIZE	COLOR	
17022	S	Black	17025	XL	Black	
17023	M	Black	17026	2XL	Black	
17024	L	Black				

9002

ORDER
MULTIPLE
1

CERTIFIED ANTI-VIBRATION GLOVES

- ANSI S2.73/ISO 10819-certified AV protection
- Patented Nu²O₂® gel polymer palm pad
- Abrasion-resistant pigskin leather palm
- Neoprene knuckle pad
- Low-profile hook and loop closure with pull-on tab

ITEM #	SIZE	COLOR	ITEM #	SIZE	COLOR
17322	S	Black	17325	XL	Black
17323	M	Black	17326	2XL	Black
17324	L	Black			

// PATENTED

9012

ORDER
MULTIPLE
1

CERTIFIED ANTI-VIBRATION GLOVES/ WRIST

- ANSI S2.73/ISO 10819-certified AV protection
- Patented Nu²O₂® gel polymer palm pad
- Abrasion-resistant pigskin leather palm
- Built-in wrist support with Open-Center Stay™
- Neoprene knuckle pad

ITEM #	SIZE	COLOR	ITEM #	SIZE	COLOR
17722	S	Black	17725	XL	Black
17723	M	Black	17726	2XL	Black
17724	L	Black			

// PATENTED

9000

ORDER
MULTIPLE
1

CERTIFIED LIGHTWEIGHT ANTI-VIBRATION

- ANSI S2.73/ISO 10819-certified AV protection
- Unique chloroprene rubber palm pad
- Breathable 7-gauge cotton/nylon seamless knit
- Comfortable, flexible pre-curved design
- Elastic cuff for secure fit

ITEM #	SIZE	COLOR
16453	M	Black
16454	L	Black
16455	XL	Black

910

ORDER
MULTIPLE
1

IMPACT GLOVES W/ WRIST SUPPORT

- Gel polymer palm pads dampen shock and impact
- Abrasion-resistant pigskin leather palm
- Half-finger design for optimal dexterity
- Built-in wrist support with Open-Center Stay™
- Neoprene knuckle pad

ITEM #	SIZE	COLOR	ITEM #	SIZE	COLOR
17422	S	Black	17425	XL	Black
17423	M	Black	17426	2XL	Black
17424	L	Black			

// PATENTED

901

ORDER
MULTIPLE
1

ECONOMY IMPACT

- EVA foam pads dampen shock and impact
- Split leather palm
- Half-finger design for optimal dexterity
- Hook and loop closure

ITEM #	SIZE	COLOR	ITEM #	SIZE	COLOR
17032	S	Black	17035	XL	Black
17033	M	Black	17036	2XL	Black
17034	L	Black			

800

ORDER
MULTIPLE
1

GLOVE LINER

- Gel polymer palm pads dampen shock and impact
- Breathable cotton/spandex body
- Half-finger design for optimal dexterity
- Can be worn alone or underneath separate gloves

ITEM #	SIZE	COLOR
16104	S/M	Black
16106	L	Black

PROFLEX® GLOVES:

FIRE & RESCUE SERIES

DIFFERENTIATED BY DESIGN

ARMORTEX® REINFORCEMENTS

Rugged Armortex® zones on palm, thumb saddle, and fingers protect against cuts, scrapes, and abrasion.

DOUBLE-NEEDLE KEVLAR® STITCHING

Double-needle Kevlar® stitching found throughout the glove for extended life and maximum durability.

REFLECTIVE KNUCKLE PAD

EVA foam knuckle pad with reflective pattern provides both protection and visibility.

ELASTIC GAITOR CUFF

Elastic cuff with gaitor inside keeps out glass and debris.



OUTDRY® BLOODBORNE PATHOGEN RESISTANCE

The 7300D features an OutDry® bonded waterproof membrane that also provides ASTM-certified bloodborne pathogen resistance.

7300D

<h1>740</h1>						ORDER MULTIPLE 1					
<h3>FIRE & RESCUE ROPE</h3>											
<ul style="list-style-type: none"> • Double-layer synthetic leather palm and fingers • Reinforced EVA-padded rope channel • Double-needle Kevlar® stitching • Stretch spandex shell for comfort and fit • Adjustable wrist cinch anchor for extra security 											
ITEM #	SIZE	COLOR	ITEM #	SIZE	COLOR						
17802	S	Black	17805	XL	Black						
17803	M	Black	17806	2XL	Black						
17804	L	Black									

<h1>730</h1>						ORDER MULTIPLE 1					
<h3>PERFORMANCE FIRE & RESCUE</h3>											
<ul style="list-style-type: none"> • Rugged Armortex®-reinforced palm & thumb saddle • Reinforced fingertip gripping zones; EVA palm pad • Double-needle Kevlar® stitching • Stretch spandex shell for comfort and fit • EVA knuckle pad with reflective pattern 											
ITEM #	SIZE	COLOR	ITEM #	SIZE	COLOR						
16362	S	HV Lime	16382	S	Black						
16363	M	HV Lime	16383	M	Black						
16364	L	HV Lime	16384	L	Black						
16365	XL	HV Lime	16385	XL	Black						
16366	2XL	HV Lime	16386	2XL	Black						

<h1>730_{OD}</h1>						ORDER MULTIPLE 1					
<h3>PERFORMANCE FIRE & RESCUE OUTDRY®</h3>											
<ul style="list-style-type: none"> • Waterproof OutDry® membrane passes ASTM F1670, 71 • Compliant protection to OSHA 29CFR 1910.1030 • Rugged Armortex®-reinforced palm & thumb saddle • Reinforced fingertip gripping zones; EVA palm pad • Stretch spandex shell for comfort and fit 											
ITEM #	SIZE	COLOR	ITEM #	SIZE	COLOR						
17102	S	HV Lime	17105	XL	HV Lime						
17103	M	HV Lime	17106	2XL	HV Lime						
17104	L	HV Lime									

MORE THAN **1,000,000** ER VISITS ANNUALLY ARE DUE TO HAND INJURIES



137,440

CASES INVOLVING INJURY TO THE HAND

53,700 ARE RELATED TO BEING STRUCK BY AN OBJECT

104,220 RELATED TO CONTACT WITH OBJECT OR EQUIPMENT MOSTLY CUTS // LACERATIONS // PUNCTURES



25-38 YEARS OLD MOST IMPACTED [33,780]



ON AVERAGE, **7 DAYS** AWAY FROM WORK

25% OF INJURIES HAPPEN ON

WEDNESDAY



25,960 INJURIES RELATED TO HAND TOOLS

25,780 INJURIES RELATED TO MACHINERY



\$6K: AVERAGE HAND INJURY CLAIM

\$7K: AVERAGE WORK COMP CLAIM

HAND AND FINGER FRACTURES ARE THE MOST COSTLY APPROXIMATELY **\$278 MILLION** EACH YEAR ALONE

AVERAGE EMERGENCY ROOM COSTS:

STITCHES UP TO **\$2,000**

LACERATIONS UP TO **\$10,000**

SEVERED TENDONS UP TO **\$70,000**

HAND // WRIST INJURIES COST **\$740 MIL** ANNUALLY

ACCORDING TO NSC INJURY FACTS 2015: HANDS **#2** MOST INJURED BODY PART **REQUIRING DAYS AWAY FROM WORK** MAKING UP...

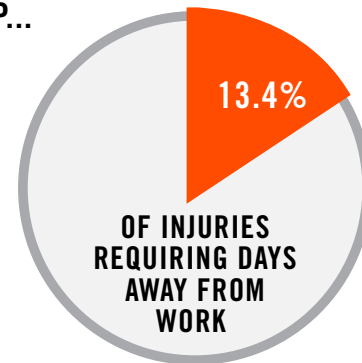

OSHA® ANALYSIS:

FOR EVERY DOLLAR INVESTED IN EFFECTIVE SAFETY AND HEALTH PROGRAMS, AN EMPLOYER CAN **EXPECT A RETURN OF \$4 TO \$6**



[SOURCE: BLS STATS 2014]



PROFLEX[®] KNEE PADS

KNEE DEEP IN COMFORT.





PROFLEX® KNEE PADS

Just like the future CEO toiling away in the mailroom, our ProFlex® Knee and Kneeling Pads start at the bottom. They provide a cushy and supportive base for you to rest your aching bones. Turn any task that should be gnarly on your knees into a patella pleasure cruise. With our ProFlex® Knee and Kneeling Pads, you'll be able to endure even the most grueling task without sacrificing your ability to stand up straight the next day. We're giving you a cushy gig even the boss's son would envy.

KNEE PADS // GEL SERIES



342 Extra Long Cap Injected Gel



344 Short Cap Injected Gel



345 Long Cap Injected Gel



355 Short Cap Injected Gel

KNEE PADS // STANDARD SERIES



300 Rounded Hard Cap



315 Long Textured Hard Cap



325 Non-Marring Rubber Cap



335 Slip-Resistant Rubber Cap

KNEE PADS // KNEELING PAD SERIES



375 Compact



380 Standard

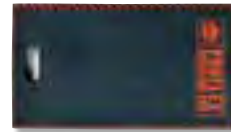

385 Large



390 Extra Large



UPDATED FOR '17

347 Long Cap Lightweight Gel



UPDATED FOR '17

357 Short Cap Lightweight Gel



UPDATED FOR '17

367 Round Cap Lightweight Gel



350 Gel Foam



340 Slip-Resistant w/ Shin Pad



200 Copolymer Foam



230 Poly Cap



260 Slip-On Cloth

PROFLEX® KNEE PADS:

GEL SERIES

DIFFERENTIATED BY DESIGN

GEL OPTIONS

Choose injected gel for rugged, all-day cushioning or lightweight gel for highly mobile comfort.

INNOVATIVE CAP DESIGN

Choose between different cap sizes and styles for a wide range of applications. Cap options for full knee and shin coverage or shorter caps for enhanced mobility.

UNIQUE STRAP STYLES

Different straps do different things: sometimes they're designed to deliver a secure fit, sometimes to relieve discomfort on the back of your knee. Take a look, you're sure to find a configuration tailored for you.



342

ORDER MULTIPLE
1

EXTRA LONG CAP INJECTED GEL

- Extra long cap for maximum coverage and stability
- Non-slip rubber cap grips kneeling surface
- Injected gel + PU foam for all-day comfort
- Breathable perforated neoprene top strap
- Bottom strap secures knee pad around calf

ITEM #	SIZE	COLOR
18442	—	Black

// PATENT PENDING

344

ORDER MULTIPLE
1

SHORT CAP INJECTED GEL W/ COMFORT STRAPS

- Short cap design for mobility when kneeling
- Non-slip rubber cap grips kneeling surface
- Injected gel + PU foam for all-day comfort
- Padded straps on thigh and calf will not bind up
- Plastic clips cinch tight and keep straps secure

ITEM #	SIZE	COLOR
18444	—	Black

// PATENT PENDING

345

ORDER MULTIPLE
1

LONG CAP INJECTED GEL

- Long cap design provides protection and stability
- Non-slip rubber cap grips kneeling surface
- Injected gel + PU foam for all-day comfort
- Breathable perforated neoprene bottom strap
- Top webbing strap cinches tight with plastic clip

ITEM #	SIZE	COLOR
18445	—	Black

// PATENT PENDING

PROFLEX® KNEE PAD GEL TECHNOLOGY

INJECTED GEL TECHNOLOGY (342, 344, 345, 355)

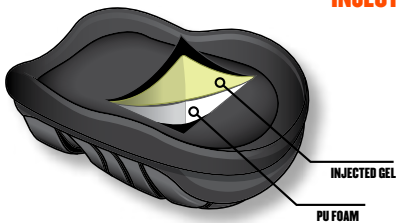

INJECTED GEL PROVIDES:
 Increased Wearer Comfort
 Improved Worker Productivity
 (Work longer in greater comfort)
 Enhanced Knee Pad Durability
 (Gel does not slide and wear)

LIGHTWEIGHT GEL TECHNOLOGY (347, 357, 367)

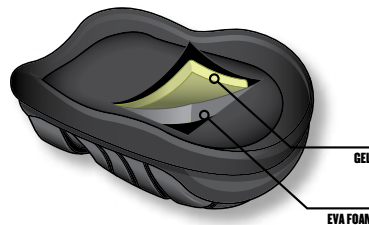

LIGHTWEIGHT GEL PROVIDES:
 Reduced Wearer Fatigue
 Lightweight Comfort
 Gel Performance at an Exceptional Value



FIND OUT MORE ABOUT THE TECHNOLOGY THAT GOES INTO THE FULL LINE OF ERGODYNE KNEE PROTECTION AT: WWW.ERGODYNE.COM

			347	ORDER MULTIPLE 1
<h3>LONG CAP LIGHTWEIGHT GEL</h3>				
				
				
<ul style="list-style-type: none"> • Long cap design provides protection and stability • Non-slip rubber cap grips kneeling surface • Lightweight gel + EVA foam for mobile comfort • Bottom webbing and top elastic straps • Plastic clips cinch tight and keep straps secure 				
ITEM #	SIZE	COLOR		
18447	—	Black		
// PATENT PENDING				

			355	ORDER MULTIPLE 1
<h3>SHORT CAP INJECTED GEL</h3>				
				
				
<ul style="list-style-type: none"> • Short cap design for mobility when kneeling • Non-slip rubber cap grips kneeling surface • Injected gel + PU foam for all-day comfort • Bottom webbing and top elastic straps • Plastic clips cinch tight and keep straps secure 				
ITEM #	SIZE	COLOR		
18455	—	Black		
// PATENT PENDING				

			357	ORDER MULTIPLE 1
<h3>SHORT CAP LIGHTWEIGHT GEL</h3>				
				
				
<ul style="list-style-type: none"> • Short cap design for mobility when kneeling • Non-slip rubber cap grips kneeling surface • Lightweight gel + EVA foam for mobile comfort • Bottom webbing and top elastic straps • Plastic clips cinch tight and keep straps secure 				
ITEM #	SIZE	COLOR		
18457	—	Black		
// PATENT PENDING				

			367	ORDER MULTIPLE 1
<h3>ROUND CAP LIGHTWEIGHT GEL</h3>				
				
				
<ul style="list-style-type: none"> • Round cap for highest degree of kneeling mobility • Non-slip rubber cap grips kneeling surface • Lightweight gel + EVA foam for mobile comfort • Breathable perforated neoprene bottom strap • Top webbing strap cinches tight with plastic clip 				
ITEM #	SIZE	COLOR		
18467	—	Black		
// PATENT PENDING				

			350	ORDER MULTIPLE 1
<h3>GEL FOAM</h3>				
				
<ul style="list-style-type: none"> • 12mm NBR gel padding & 20mm EVA padding • 1680D ballistic nylon outer shell • Slip-resistant durable 420D nylon-rubber surface • Adjustable, breathable neoprene stretch strap • Hook and loop closure 				
ITEM #	SIZE	COLOR		
18350	—	Black		

OFFICIAL PRODUCT REVIEW



TENACIOUS TESTER™
APPROVED

unscripted • unbiased • unabashed

TESTER: JASON HESS

PRODUCT: 347

“Can they take a beating? They’re built to last! From the stitching to the buckles they are quality, and it shows. The material that makes up the contact face of the knee pad is perfect, not near perfect, not close to, but PERFECT! I have used them on wood decking, concrete floors, steel beams, dirt, stone, just to name a few and it has held up beautifully. A couple scuffs here and there to let the Mrs. know you’ve been working but other than that they look brand new.”

ONE WORD REVIEW: PERFECT

THE AVERAGE COST FOR EFFECTIVE, HIGH QUALITY KNEE PROTECTION IS \$30 PER EMPLOYEE. YOU'LL SPEND BETWEEN \$1,000-\$3,000 ON A KNEE INJURY MRI IN THE U.S. *QUORA

104,090

CASES INVOLVING INJURY TO THE KNEE IN THE US IN 2014

50,420 AS A RESULT OF SLIPS, TRIPS, AND FALLS



31,150 OF THOSE WERE ON THE SAME LEVEL

OVEREXERTION IS ACCOUNTABLE FOR **35,520**

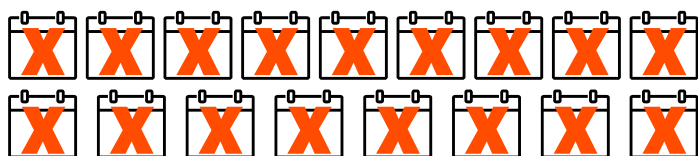

ON AVERAGE, **17 DAYS** AWAY FROM WORK



SHEDDING JUST 15LBS. CAN CUT PAIN IN HALF!

700,000

KNEE REPLACEMENT SURGERIES PER YEAR

\$49,500: AVERAGE COST FOR A KNEE REPLACEMENT

AVERAGE RECOVERY TIME: **12 WEEKS**

OSTEOARTHRITIS (WEAR-AND-TEAR ARTHRITIS)

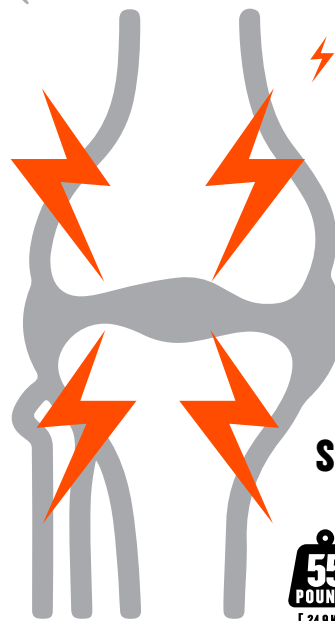

⚡ THE REDUCTION
⚡⚡⚡ IN NATURAL
⚡⚡⚡ CUSHIONING
BETWEEN JOINTS
AND CARTILAGE
REPETITIVE KNEELING,
SQUATTING, AND LIFTING
WEIGHTS OVER 55LBS.
INCREASES RISK OF
DEVELOPMENT



27,000,000+ PEOPLE IN THE U.S. HAVE OSTEOARTHRITIS OF THE KNEE



YOUR RISK FOR OSTEOARTHRITIS RISES AFTER THE AGE OF 45

OSHA[®] ANALYSIS:

FOR EVERY DOLLAR INVESTED IN EFFECTIVE SAFETY AND HEALTH PROGRAMS, AN EMPLOYER CAN **EXPECT A RETURN OF \$4 TO \$6**



[SOURCE: BLS STATS 2014]

PROFLEX® KNEE PADS:

STANDARD SERIES

DIFFERENTIATED BY DESIGN

CLOSURE OPTIONS

Select non-marring hook and loop closures or infinitely variable buckles that will not snag on carpet or pick up grime. Both closures adjust quickly for a comfortable fit.



300HL

MULTIPLE CAP STYLES

Choose the right cap for the application. Whether you want to rock, lean, slide, or stay stable, there are many cap sizes and shapes to choose from.

NBR FOAM PADDING

Inside the 840D nylon fabric cover is 12mm NBR foam padding cut to hug the knee for superior cushioning and kneeling comfort.



300

ORDER MULTIPLE
1

ROUNDED HARD CAP



- Abrasion-resistant rounded short hard cap
- 840D nylon fabric cover
- 12mm NBR foam padding cut to hug the knee
- Nickel-plated grommets
- Buckle or hook and loop closure

300: BUCKLE

ITEM #	SIZE	COLOR
18300	—	White Cap

300HL: HOOK AND LOOP

ITEM #	SIZE	COLOR
18301	—	White Cap



315

ORDER MULTIPLE
1

LONG TEXTURED HARD CAP



- Abrasion-resistant long hard cap
- 840D nylon fabric cover
- 12mm NBR foam padding cut to hug the knee
- Nickel-plated grommets
- Buckle or hook and loop closure

315: BUCKLE

ITEM #	SIZE	COLOR
18315	—	White Cap

315HL: HOOK AND LOOP

ITEM #	SIZE	COLOR
18316	—	White Cap

325

ORDER
MULTIPLE
1

NON-MARRING RUBBER CAP



- Non-marring long cap
- 840D nylon fabric cover
- 12mm NBR foam padding cut to hug the knee
- Nickel-plated grommets
- Buckle or hook and loop closure

325: BUCKLE

ITEM #	SIZE	COLOR
18325	—	Tan Cap

325HL: HOOK AND LOOP

ITEM #	SIZE	COLOR
18326	—	Tan Cap

335

ORDER
MULTIPLE
1

SLIP RESISTANT RUBBER CAP



- Slip-resistant long rubber cap to grip surfaces
- 840D nylon fabric cover
- 12mm NBR foam padding cut to hug the knee
- Nickel-plated grommets
- Buckle or hook and loop closure

335: BUCKLE

ITEM #	SIZE	COLOR
18335	—	Black Cap

335HL: HOOK AND LOOP

ITEM #	SIZE	COLOR
18336	—	Black Cap

340

ORDER
MULTIPLE
1

SLIP RESISTANT RUBBER CAP W/ SHIN GUARD



- Slip-resistant long rubber cap to grip surfaces
- 840D nylon fabric cover with tapered shin guard
- 12mm NBR foam padding cut to hug the knee
- Nickel-plated grommets
- Buckle closure

ITEM #	SIZE	COLOR
18340	—	Black Cap

200

ORDER
MULTIPLE
1

SHORT LIGHT DUTY COPOLYMER



- Durable copolymer padding
- Super lightweight for comfortable all day wear
- Single strap with hook and loop closure

ITEM #	SIZE	COLOR
18200	—	Black

230

ORDER
MULTIPLE
1

WIDE SOFT CAP



- Durable 600D polyester fabric cover
- 15mm closed cell foam padding
- Slightly wider and longer for wraparound comfort
- Anti-odor treatment
- Buckle or hook and loop closure

230: BUCKLE

ITEM #	SIZE	COLOR
18230	—	Black

230HL: HOOK AND LOOP

ITEM #	SIZE	COLOR
18231	—	Black

260

ORDER
MULTIPLE
1

SOFT SLIP-ON



- Lightweight, slip-on knee pads
- Soft outer cloth and foam padding
- Woven elastic sleeve for easy on and off
- Wear over or under clothing

ITEM #	SIZE	COLOR
18260	—	Black

PROFLEX® KNEELING PADS:

KNEELING PAD SERIES

DIFFERENTIATED BY DESIGN

NBR FOAM

Made from high density NBR foam that won't bottom out for long-lasting support and comfort.

BEVELED EDGE AND SAFETY ORANGE STRIPING

Beveled edge and safety orange striping on certain models for visibility of the worker and kneeling pad.

PETROLEUM RESISTANT AND SILICONE-FREE

High-quality foam will not break down in the harshest of applications; silicone-free allows for safe, non-corrosive usage.

CONVENIENT HANDLE

Handle cut-out for easy carrying and convenient for hanging storage.



	375	ORDER MULTIPLE 1						
<p>COMPACT KNEELING PAD</p> <div style="text-align: center; margin: 20px 0;">  </div> <ul style="list-style-type: none"> • Compact size for optimal portability • Convenient handle also allows for hanging storage • 8" x 18" x 1" (20cm x 46cm x 2.5cm) • Fits in the Arsenal® 5845 Trades Tool Organizer <table border="1" style="width: 100%; border-collapse: collapse; margin-top: 20px;"> <thead> <tr> <th style="text-align: left;">ITEM #</th> <th style="text-align: left;">SIZE</th> <th style="text-align: left;">COLOR</th> </tr> </thead> <tbody> <tr> <td>18376</td> <td>—</td> <td>Orange</td> </tr> </tbody> </table>			ITEM #	SIZE	COLOR	18376	—	Orange
ITEM #	SIZE	COLOR						
18376	—	Orange						

	380	ORDER MULTIPLE 1									
<p>STANDARD KNEELING PAD</p> <div style="text-align: center; margin: 20px 0;">  </div> <ul style="list-style-type: none"> • Standard size for optimal portability • Convenient handle also allows for hanging storage • 14" x 21" x 1" (36cm x 53cm x 2.5cm) • Available in black and orange <table border="1" style="width: 100%; border-collapse: collapse; margin-top: 20px;"> <thead> <tr> <th style="text-align: left;">ITEM #</th> <th style="text-align: left;">SIZE</th> <th style="text-align: left;">COLOR</th> </tr> </thead> <tbody> <tr> <td>18380</td> <td>—</td> <td>Black</td> </tr> <tr> <td>18381</td> <td>—</td> <td>Orange</td> </tr> </tbody> </table>			ITEM #	SIZE	COLOR	18380	—	Black	18381	—	Orange
ITEM #	SIZE	COLOR									
18380	—	Black									
18381	—	Orange									

	385	ORDER MULTIPLE 1						
<p>LARGE KNEELING PAD</p> <div style="text-align: center; margin: 20px 0;">  </div> <ul style="list-style-type: none"> • Larger work surface • Beveled safety edge with orange warning stripes • Convenient handle also allows for hanging storage • 16" x 28" x 1" (41cm x 71cm x 2.5cm) <table border="1" style="width: 100%; border-collapse: collapse; margin-top: 20px;"> <thead> <tr> <th style="text-align: left;">ITEM #</th> <th style="text-align: left;">SIZE</th> <th style="text-align: left;">COLOR</th> </tr> </thead> <tbody> <tr> <td>18385</td> <td>—</td> <td>Black</td> </tr> </tbody> </table>			ITEM #	SIZE	COLOR	18385	—	Black
ITEM #	SIZE	COLOR						
18385	—	Black						

	390	ORDER MULTIPLE 1						
<p>EXTRA LARGE KNEELING PAD</p> <div style="text-align: center; margin: 20px 0;">  </div> <ul style="list-style-type: none"> • Larger work surface • Beveled safety edge with orange warning stripes • Convenient handle also allows for hanging storage • 18" x 36" x 1" (46cm x 91cm x 2.5cm) <table border="1" style="width: 100%; border-collapse: collapse; margin-top: 20px;"> <thead> <tr> <th style="text-align: left;">ITEM #</th> <th style="text-align: left;">SIZE</th> <th style="text-align: left;">COLOR</th> </tr> </thead> <tbody> <tr> <td>18390</td> <td>—</td> <td>Black</td> </tr> </tbody> </table>			ITEM #	SIZE	COLOR	18390	—	Black
ITEM #	SIZE	COLOR						
18390	—	Black						

PROFLEX® KNEELING PAD SELECT-O-MATIC

A handy little chart to help you size up the situation.





PROFLEX[®] SUPPORTS



**BACK IN THE SADDLE.
IF YOUR SADDLE IS
CHECKING THE LINE.**



PROFLEX® SUPPORTS

You load 16 tons and what do you get? A slipped disc and three weeks of bed rest. No dice. That's unacceptable from where we stand. Slip into ProFlex® comfort and security next time you're tasked with carrying the weight of the world. We've led the way in support technologies and innovation for 30 years. So allow us to ease your burden and get one over on the company store.

SUPPORTS // BACK SUPPORT SERIES



2000SF Performance Spandex



1100SF Standard Spandex



100 Economy Spandex



1400UN Universal Fit Spandex

SUPPORTS // WRIST SUPPORT SERIES



4000 Single Strap



4010 Double Strap



4020 Lightweight



670 Single Strap Ambi

SUPPORTS // WRAPS & SLEEVES SERIES



400 Wrist Wrap



420 Wrist Wrap w/ Thumb Loop



500 Elbow Wrap



600 Knee Sleeve



1051 Mesh w/ Lumbar Pad



1600 Standard Elastic



1650 Economy Elastic



1500 Weight Lifters



1505 Low-Profile Weight Lifters



675 Double Strap Ambi



615 Open Knee Sleeve



620 Knee Sleeve w/ Stays



650 Elbow Sleeve



655 Elbow Sleeve w/ Strap

PROFLEX® SUPPORTS:

BACK SUPPORT SERIES

DIFFERENTIATED BY DESIGN

V-SHAPED DESIGN

V-shaped design helps support the natural shape of the human body for better fit and ultimately better effectiveness.

POWER PANEL POSITIONERS™

Innovative positioners keep the power panels in place so they are ready to be activated when needed and do not cause a hazard hanging behind you.

STICKY FINGERS® STAYS

Patented Sticky Fingers® Stays help keep the back support in position.



			1100 ^{SF}			ORDER MULTIPLE 1
STANDARD SPANDEX BACK SUPPORT						
<ul style="list-style-type: none"> • 8" premium durable 280D spandex body material • Patented non-conductive Sticky Fingers® stays • Innovative Power Panel Positioners™ • Stretchable bias binding with zig-zag stitching • Adjustable, detachable suspenders 						
ITEM #	SIZE	COLOR	ITEM #	SIZE	COLOR	
11601	XS	Black	11605	XL	Black	
11602	S	Black	11606	2XL	Black	
11603	M	Black	11607	3XL	Black	
11604	L	Black	11608	4XL	Black	
// PATENTED						

			100			ORDER MULTIPLE 1
ECONOMY SPANDEX BACK SUPPORT						
<ul style="list-style-type: none"> • 8" economical spandex body • Non-conductive polypropylene stays • 280D spandex body material • Adjustable, detachable suspenders • Rubber track webbing 						
ITEM #	SIZE	COLOR	ITEM #	SIZE	COLOR	
11381	XS	Black	11385	XL	Black	
11382	S	Black	11386	2XL	Black	
11383	M	Black	11387	3XL	Black	
11384	L	Black	11388	4XL	Black	

			100 ^{HV}			ORDER MULTIPLE 1
ECONOMY HI-VIS SPANDEX BACK SUPPORT						
<ul style="list-style-type: none"> • 8" economical hi-vis spandex body • Non-conductive polypropylene stays • Adjustable, detachable suspenders • Rubber track webbing • Stretchable bias binding with zig-zag stitching 						
ITEM #	SIZE	COLOR	ITEM #	SIZE	COLOR	
11881	XS	HV Orange	11885	XL	HV Orange	
11882	S	HV Orange	11886	2XL	HV Orange	
11883	M	HV Orange	11887	3XL	HV Orange	
11884	L	HV Orange	11888	4XL	HV Orange	

			2000 ^{SF}			ORDER MULTIPLE 1
HIGH PERFORMANCE SPANDEX BACK SUPPORT						
<ul style="list-style-type: none"> • 8.5" 840D spandex body material • Patented non-conductive Sticky Fingers® stays • Innovative Power Panel Positioners™ • Unique V-shaped design • Adjustable, detachable suspenders 						
ITEM #	SIZE	COLOR	ITEM #	SIZE	COLOR	
11281	XS	Black	11285	XL	Black	
11282	S	Black	11286	2XL	Black	
11283	M	Black	11287	3XL	Black	
11284	L	Black	11288	4XL	Black	
// PATENTED						

1400_{UN}

ORDER MULTIPLE
1

UNIVERSAL SIZE BACK SUPPORT



- 8.75" durable 280D spandex body material
- Universal size: fits most waists
- Non-conductive polypropylene stays
- Adjustable, detachable suspenders
- Rubber track webbing

ITEM #	SIZE	COLOR
11400	—	Black

1600

ORDER MULTIPLE
1

STANDARD ELASTIC BACK SUPPORT



- 9" premium all-elastic body for extra firm support
- Contoured high-cut front panel
- Non-conductive polypropylene stays
- Adjustable, detachable suspenders
- Rubber track webbing

ITEM #	SIZE	COLOR	ITEM #	SIZE	COLOR
11101	XS	Black	11105	XL	Black
11102	S	Black	11106	2XL	Black
11103	M	Black	11107	3XL	Black
11104	L	Black	11108	4XL	Black

1650

ORDER MULTIPLE
1

ECONOMY ELASTIC BACK SUPPORT



- 7.5" economical all-elastic body
- 5" (12.7cm) single strap closure
- Non-conductive polypropylene stays
- Adjustable, detachable suspenders
- Rubber track webbing

ITEM #	SIZE	COLOR	ITEM #	SIZE	COLOR
11091	XS	Black	11095	XL	Black
11092	S	Black	11096	2XL	Black
11093	M	Black	11097	3XL	Black
11094	L	Black	11098	4XL	Black

1051

ORDER MULTIPLE
1

MESH BACK SUPPORT WITH LUMBAR PAD



- 10" breathable mesh outer shell
- Innovative Power Panel Positioners™
- Contoured ventilated lumbar pad
- Two-stage closure

ITEM #	SIZE	COLOR	ITEM #	SIZE	COLOR
20183	S	Black	20186	XL	Black
20184	M	Black	20187	2XL	Black
20185	L	Black			

1500

ORDER MULTIPLE
1

STANDARD WEIGHT LIFTERS STYLE BACK SUPPORT



- 7.75" rigid foam body
- Durable 900D foam laminated nylon body fabric
- Foam lumbar pad

ITEM #	SIZE	COLOR	ITEM #	SIZE	COLOR
11471	S	Black	11474	XL	Black
11472	M	Black	11475	2XL	Black
11473	L	Black			

1505

ORDER MULTIPLE
1

LOW-PROFILE WEIGHT LIFTERS STYLE BACK SUPPORT



- 6.25" low-profile tapered design
- Flexible soft foam core composition
- Nylon jersey body fabric
- Easy cam buckle closure system
- Rubber track webbing

ITEM #	SIZE	COLOR	ITEM #	SIZE	COLOR
11491	S	Black	11494	XL	Black
11492	M	Black	11495	2XL	Black
11493	L	Black			

PROFLEX® SUPPORTS:

WRIST SUPPORT SERIES

DIFFERENTIATED BY DESIGN:

ANTI-ODOR TREATMENT

Body-side surfaces are treated to eliminate odor-causing bacterial growth.

OPEN-CENTER STAY™

Patented design includes open center to reduce pressure on median nerve while the contoured design follows the wrist's natural shape.

ELASTIC OR NEOPRENE CONSTRUCTION

Depending on how much support is needed, choose between neoprene or woven elastic wrist supports with straps that limit flexion or extension movements.



4000



FIND OUT MORE ABOUT THE TECHNOLOGY THAT GOES INTO THE FULL LINE OF ERGODYNE WRAPS & SUPPORTS AT: WWW.ERGODYNE.COM

4000

ORDER MULTIPLE
1

SINGLE STRAP WRIST SUPPORT

- Limits downward wrist movements
- Patented Open-Center Stay™
- Single strap; elastic
- Three-stage hook and loop closure
- Anti-odor treatment

ITEM #	SIZE	COLOR	ITEM #	SIZE	COLOR
70002	S-Right	Black	70102	S-Right	Tan
70004	M-Right	Black	70104	M-Right	Tan
70006	L-Right	Black	70106	L-Right	Tan
70008	XL-Right	Black	70108	XL-Right	Tan
70012	S-Left	Black	70112	S-Left	Tan
70014	M-Left	Black	70114	M-Left	Tan
70016	L-Left	Black	70116	L-Left	Tan
70018	XL-Left	Black	70118	XL-Left	Tan

// PATENTED

4010

ORDER MULTIPLE
1

DOUBLE STRAP WRIST SUPPORT

- Limits downward and upward wrist movements
- Patented Open-Center Stay™
- Double strap; elastic
- Three-stage hook and loop closure
- Anti-odor treatment

ITEM #	SIZE	COLOR	ITEM #	SIZE	COLOR
70022	S-Right	Black	70122	S-Right	Tan
70024	M-Right	Black	70124	M-Right	Tan
70026	L-Right	Black	70126	L-Right	Tan
70028	XL-Right	Black	70128	XL-Right	Tan
70032	S-Left	Black	70132	S-Left	Tan
70034	M-Left	Black	70134	M-Left	Tan
70036	L-Left	Black	70136	L-Left	Tan
70038	XL-Left	Black	70138	XL-Left	Tan

// PATENTED

4020

ORDER MULTIPLE
1

LIGHTWEIGHT WRIST SUPPORT

- Lightweight, vented, compact design
- Patented Open-Center Stay™
- Neoprene
- Hook and loop closure

ITEM #	SIZE	COLOR	ITEM #	SIZE	COLOR
70202	XS/S-Right	Black	70282	XS/S-Left	Gray
70204	M-Right	Black	70284	M-Left	Gray
70206	L/XL-Right	Black	70286	L/XL-Left	Gray
70208	2XL-Right	Black	70288	2XL-Left	Gray
70242	XS/S-Left	Black	70292	XS/S-Right	Gray
70244	M-Left	Black	70294	M-Right	Gray
70246	L/XL-Left	Black	70296	L/XL-Right	Gray
70248	2XL-Left	Black	70298	2XL-Right	Gray

// PATENTED

670

ORDER MULTIPLE
1

SINGLE STRAP AMBI WRIST SUPPORT

- Neoprene
- Ambidextrous
- Reversible hook and loop strap

ITEM #	SIZE	COLOR
16612	S	Black
16613	M	Black
16614	L	Black
16615	XL	Black

675

ORDER MULTIPLE
1

DOUBLE STRAP AMBI WRIST SUPPORT

- Neoprene
- Ambidextrous
- Two reversible hook and loop straps

ITEM #	SIZE	COLOR
16622	S	Black
16623	M	Black
16624	L	Black
16625	XL	Black

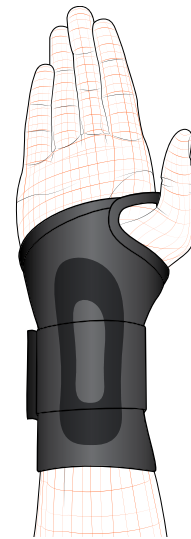

PATENTED OPEN-CENTER STAY™

Unlike traditional stay configurations positioned directly over the carpal tunnel, our stay is uniquely designed with an open center to reduce pressure on the median nerve. With a contoured design that follows the wrist's natural shape, the patented, molded stay offers greater worker comfort and compliance.

PROFLEX® SUPPORTS:

WRAPS & SLEEVES SERIES

DIFFERENTIATED BY DESIGN

	400	ORDER MULTIPLE 6
UNIVERSAL WRIST WRAP		
		
<ul style="list-style-type: none"> • Elastic • Ambidextrous • Reversible hook and loop closure 		
ITEM #	SIZE	COLOR
72102	—	Black
72103	—	Tan

	420	ORDER MULTIPLE 6
WRIST WRAP W/ THUMB LOOP		
		
<ul style="list-style-type: none"> • Elastic • Thumb loop • Hook and loop closure • Ambidextrous 		
ITEM #	SIZE	COLOR
72222	S/M	Black
72224	L/XL	Black
72232	S/M	Tan
72234	L/XL	Tan

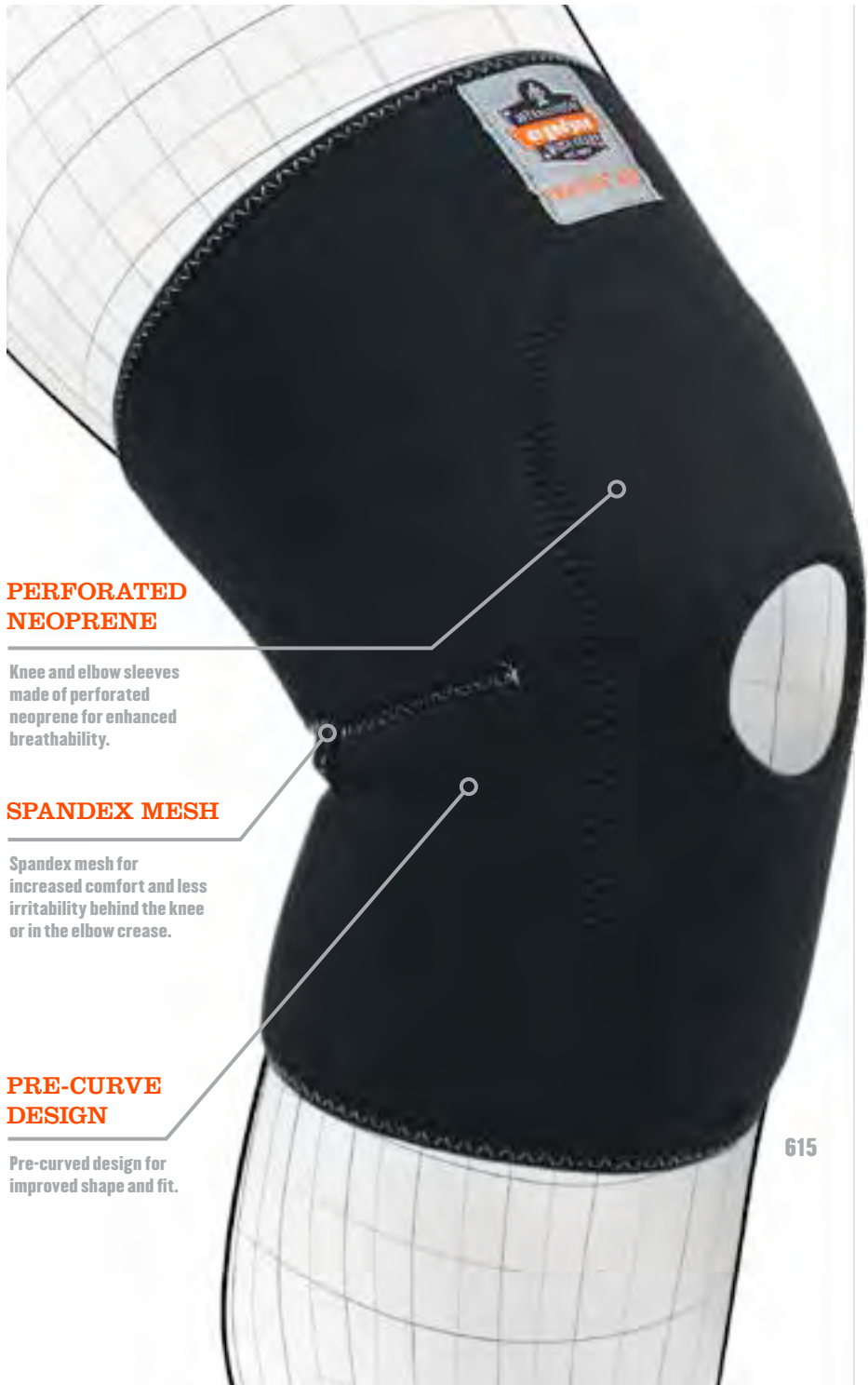

PERFORATED NEOPRENE

Knee and elbow sleeves made of perforated neoprene for enhanced breathability.

SPANDEX MESH

Spandex mesh for increased comfort and less irritability behind the knee or in the elbow crease.

PRE-CURVE DESIGN

Pre-curved design for improved shape and fit.

600

ORDER
MULTIPLE
1

SINGLE-LAYER NEOPRENE KNEE SLEEVE

- Perforated neoprene
- Binding and pre-curve design
- Spandex mesh behind the knee

ITEM #	SIZE	COLOR	ITEM #	SIZE	COLOR
16502	S	Black	16505	XL	Black
16503	M	Black	16506	2XL	Black
16504	L	Black			

615

ORDER
MULTIPLE
1

KNEE SLEEVE W/ OPEN PATELLA/ANTERIOR PAD

- Perforated neoprene
- Binding and pre-curve design
- Spandex mesh behind the knee
- Double neoprene anterior pad
- Open patella

ITEM #	SIZE	COLOR	ITEM #	SIZE	COLOR
16532	S	Black	16535	XL	Black
16533	M	Black	16536	2XL	Black
16534	L	Black			

620

ORDER
MULTIPLE
1

KNEE SLEEVE W/ OPEN PATELLA/SPIRAL STAYS

- Perforated neoprene
- Binding and pre-curve design
- Thinner perforated neoprene panel behind the knee
- Spiral stays
- Foam buttress support around open patella

ITEM #	SIZE	COLOR	ITEM #	SIZE	COLOR
16542	S	Black	16545	XL	Black
16543	M	Black	16546	2XL	Black
16544	L	Black			

500

ORDER
MULTIPLE
1

ELBOW SUPPORT WRAP

- Nylon laminated neoprene
- Strap with hook and loop closure
- Ambidextrous

ITEM #	SIZE	COLOR	ITEM #	SIZE	COLOR
16001	XS	Black	16004	L	Black
16002	S	Black	16005	XL	Black
16003	M	Black			

650

ORDER
MULTIPLE
1

NEOPRENE ELBOW SLEEVE

- Perforated neoprene
- Spandex mesh in elbow crease
- Binding and pre-curve design

ITEM #	SIZE	COLOR	ITEM #	SIZE	COLOR
16572	S	Black	16575	XL	Black
16573	M	Black	16576	2XL	Black
16574	L	Black			

655

ORDER
MULTIPLE
1

NEOPRENE ELBOW SLEEVE W/ STRAP

- Perforated neoprene
- Spandex mesh in elbow crease
- Binding and pre-curve design
- Adjustable hook and loop strap

ITEM #	SIZE	COLOR	ITEM #	SIZE	COLOR
16582	S	Black	16585	XL	Black
16583	M	Black	16586	2XL	Black
16584	L	Black			



GLOWEAR®
HI-VIS APPAREL

**SHINE ON YOU
CRAZY DIAMOND.**



GLOWEAR® HI-VIS APPAREL

Working third shift on I-90. Crawling below the Earth's crust on the hunt for the next mother lode. Dangling from a high-tension wire amid a citywide blackout. It's at these moments that you need to be visible. Highly visible. To avoid drama on the job, outfit yourself in our ANSI-compliant GloWear® Line and become a beacon unto others.

HI-VIS APPAREL // CLASS 2 VEST SERIES



8250Z Surveyors



8246Z Two-Tone All Mesh



8254HDZ Heavy-Duty Surveyors



8230Z Two-Tone

HI-VIS APPAREL // CLASS 3 SERIES



8310HL Economy Mesh



8320Z Standard Mesh



8330Z Standard Two-Tone



8356FRHL Flame Resistant

HI-VIS APPAREL // CLASS 1 & NON-CERT SERIES



8020HL Non-Certified



8140BA Breakaway Sash



8040HL Hi-Gloss Reflective



8080BAX Breakaway Hi-Gloss

HI-VIS APPAREL // FOUL WEATHER SERIES



8365BK Rain Jacket



8365 Rain Jacket



8385 Thermal 4-in-1 Jacket



8379 Bomber Jacket

HI-VIS APPAREL // HEADWEAR SERIES & ACCESSORIES



8935 Ranger Hat



8930 Baseball Cap



8006 Neck Shade



8005 Mesh Neck Shade



8225HL Standard Solid



8220Z Standard Mesh



82168A Breakaway Mesh



8210HL Economy Mesh



8260FRHL Flame Resistant

HI-VIS APPAREL
// CLASS E SERIES



8910 Standard Mesh



8910BK Black Bottom Mesh



8911 Two-Tone Mesh



8008 Leg Gaiters

HI-VIS APPAREL
// SHIRT SERIES



8289BK T-Shirt



8291BK Long Sleeve T-Shirt



8295 Polo Shirt



8392 Full-Zip Hoodie



8377 Quilted Bomber Jacket



8380 Bomber Jacket



8915BK Rain Pants



8918BK Rain Bibs



8925 Class E Thermal Pants

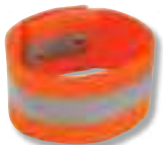

8001 Arm Band



8003 Hi-Gloss Arm Band



8004 Hi-Vis Seat Belt Cover

GLOWEAR® HI-VIS APPAREL:

CLASS 2 SERIES

DIFFERENTIATED BY DESIGN

ANSI-COMPLIANT MATERIALS

GloWear® Hi-Vis Apparel is made of ANSI-compliant reflective and background materials to ensure the highest performance.

POCKET OPTIONS

Multiple pocket configurations on vest including large outside pockets to fit a tablet, and large cellphone, multidivisional pocket, and zippered back document/tablet pocket.

3M™ SCOTCHLITE™ REFLECTIVE MATERIAL

3M™ Scotchlite™ glass bead reflective tape meets the ANSI 107 standard and improves visibility of the worker.

CLOSURE OPTIONS

Choose between a variety of hook and loop or zippered vest options.

MIC TABS

Durable webbing on shoulders to hold radio mic.



8250Z

ANSI 107		8205 _{HL/Z}		ORDER MULTIPLE 1	
TYPE R CLASS 2 SUPER ECONO MESH VEST					
					
<ul style="list-style-type: none"> • ANSI-compliant polyester mesh (3.3oz) • 2" ANSI-compliant reflective 					
8205HL: HOOK AND LOOP		8205Z: ZIPPER			
ITEM #	SIZE	COLOR	ITEM #	SIZE	COLOR
20961	XS	HV Orange	20983	S/M	HV Orange
20963	S/M	HV Orange	20985	L/XL	HV Orange
20965	L/XL	HV Orange	20987	2XL/3XL	HV Orange
20967	2XL/3XL	HV Orange	20989	4XL/5XL	HV Orange
20969	4XL/5XL	HV Orange	20993	S/M	HV Lime
20971	XS	HV Lime	20995	L/XL	HV Lime
20973	S/M	HV Lime	20997	2XL/3XL	HV Lime
20975	L/XL	HV Lime	20999	4XL/5XL	HV Lime
20977	2XL/3XL	HV Lime			
20979	4XL/5XL	HV Lime			

ANSI 107		8210 _{HL/Z}		ORDER MULTIPLE 1	
TYPE R CLASS 2 ECONO MESH VEST					
					
<ul style="list-style-type: none"> • ANSI-compliant polyester mesh (3.3oz) • 2" ANSI-compliant reflective 					
8210HL: HOOK AND LOOP		8210Z: ZIPPER			
ITEM #	SIZE	COLOR	ITEM #	SIZE	COLOR
21013	S/M	HV Orange	21043	S/M	HV Orange
21015	L/XL	HV Orange	21045	L/XL	HV Orange
21017	2XL/3XL	HV Orange	21047	2XL/3XL	HV Orange
21019	4XL/5XL	HV Orange	21049	4XL/5XL	HV Orange
21023	S/M	HV Lime	21053	S/M	HV Lime
21025	L/XL	HV Lime	21055	L/XL	HV Lime
21027	2XL/3XL	HV Lime	21057	2XL/3XL	HV Lime
21029	4XL/5XL	HV Lime	21059	4XL/5XL	HV Lime

ANSI 107		8215 _{BA}		ORDER MULTIPLE 1	
TYPE R CLASS 2 ECONO BREAKAWAY MESH VEST					
					
<ul style="list-style-type: none"> • ANSI-compliant polyester mesh (3.3oz) • Hook and loop front closure • Five-point hook and loop breakaway • 2" ANSI-compliant reflective • One pocket; single mic tab 					
ITEM #	SIZE	COLOR	ITEM #	SIZE	COLOR
21061	XS	HV Orange	21071	XS	HV Lime
21063	S/M	HV Orange	21073	S/M	HV Lime
21065	L/XL	HV Orange	21075	L/XL	HV Lime
21067	2XL/3XL	HV Orange	21077	2XL/3XL	HV Lime
21069	4XL/5XL	HV Orange	21079	4XL/5XL	HV Lime

8216_{BA}

ORDER MULTIPLE
1

TYPE R CLASS 2 BREAKAWAY W/ID MESH VEST

NEW FOR
'17

POCKETS
1 1
INNER OUTER

- ANSI-compliant polyester mesh (3.3oz)
- Hook and loop closure
- Breakaway design on shoulders and sides
- 2" ANSI-compliant 3M™ Scotchlite™ Reflective
- One inside pocket; one outer clear ID pocket

ITEM #	SIZE	COLOR	ITEM #	SIZE	COLOR
21083	S/M	HV Orange	21093	S/M	HV Lime
21085	L/XL	HV Orange	21095	L/XL	HV Lime
21087	2XL/3XL	HV Orange	21097	2XL/3XL	HV Lime
21089	4XL/5XL	HV Orange	21099	4XL/5XL	HV Lime

8220_{HL/Z}

ORDER MULTIPLE
1

TYPE R CLASS 2 STANDARD MESH VEST

POCKETS
1 2
INNER OUTER

- ANSI-compliant polyester mesh (3.3oz)
- 2" ANSI-compliant reflective

8220HL: HOOK AND LOOP

ITEM #	SIZE	COLOR
21133	S/M	HV Orange
21135	L/XL	HV Orange
21137	2XL/3XL	HV Orange
21139	4XL/5XL	HV Orange
21143	S/M	HV Lime
21145	L/XL	HV Lime
21147	2XL/3XL	HV Lime
21149	4XL/5XL	HV Lime

8220Z: ZIPPER

ITEM #	SIZE	COLOR
21113	S/M	HV Orange
21115	L/XL	HV Orange
21117	2XL/3XL	HV Orange
21119	4XL/5XL	HV Orange
21123	S/M	HV Lime
21125	L/XL	HV Lime
21127	2XL/3XL	HV Lime
21129	4XL/5XL	HV Lime

8225_{HL/Z}

ORDER MULTIPLE
1

TYPE R CLASS 2 STANDARD SOLID VEST

POCKETS
1 2
INNER OUTER

- ANSI-compliant polyester solid (3.6oz)
- 2" ANSI-compliant reflective

8225HL: HOOK AND LOOP

ITEM #	SIZE	COLOR
21173	S/M	HV Orange
21175	L/XL	HV Orange
21177	2XL/3XL	HV Orange
21179	4XL/5XL	HV Orange
21183	S/M	HV Lime
21185	L/XL	HV Lime
21187	2XL/3XL	HV Lime
21189	4XL/5XL	HV Lime

8225Z: ZIPPER

ITEM #	SIZE	COLOR
21153	S/M	HV Orange
21155	L/XL	HV Orange
21157	2XL/3XL	HV Orange
21159	4XL/5XL	HV Orange
21163	S/M	HV Lime
21165	L/XL	HV Lime
21167	2XL/3XL	HV Lime
21169	4XL/5XL	HV Lime

8229_Z

ORDER MULTIPLE
1

TYPE R CLASS 2 ECONOMY TWO-TONE MESH VEST

POCKETS
1 0
INNER OUTER

- ANSI-compliant polyester mesh (3.3oz)
- 2" ANSI-compliant reflective
- Reflective set on 3.5" contrasting background
- Zipper closure
- One pocket; single mic tab

ITEM #	SIZE	COLOR	ITEM #	SIZE	COLOR
21301	XS	HV Orange	21291	XS	HV Lime
21303	S/M	HV Orange	21293	S/M	HV Lime
21305	L/XL	HV Orange	21295	L/XL	HV Lime
21307	2XL/3XL	HV Orange	21297	2XL/3XL	HV Lime
21309	4XL/5XL	HV Orange	21299	4XL/5XL	HV Lime

8230_Z

ORDER MULTIPLE
1

TYPE R CLASS 2 TWO-TONE MESH VEST

POCKETS
1 0
INNER OUTER

- ANSI-compliant polyester mesh (3.3oz)
- 2" ANSI-compliant 3M™ Scotchlite™ Reflective
- Reflective set on 3.5" contrasting background
- Zipper closure
- One pocket; single mic tab

ITEM #	SIZE	COLOR	ITEM #	SIZE	COLOR
21313	S/M	HV Orange	21323	S/M	HV Lime
21315	L/XL	HV Orange	21325	L/XL	HV Lime
21317	2XL/3XL	HV Orange	21327	2XL/3XL	HV Lime
21319	4XL/5XL	HV Orange	21329	4XL/5XL	HV Lime

8235_{ZX}

ORDER MULTIPLE
1

TYPE R CLASS 2 TWO-TONE X-BACK VEST

POCKETS
1 4
INNER OUTER

- ANSI-compliant polyester solid (3.6oz)
- 2" ANSI-compliant 3M™ Scotchlite™ Reflective
- Reflective set on 3.5" contrasting background
- Zipper closure
- Five pockets; D-ring access slot

ITEM #	SIZE	COLOR
26183	S/M	HV Orange
26185	L/XL	HV Orange
26187	2XL/3XL	HV Orange
26189	4XL/5XL	HV Orange



8246_Z



ORDER MULTIPLE
1

TYPE R CLASS 2 TWO-TONE ALL MESH VEST

NEW FOR

'17



POCKETS

2 **4**

INNER OUTER

- ANSI-compliant polyester mesh (3.3oz)
- Zipper closure
- 2" ANSI-compliant reflective
- Reflective set on 3.5" contrasting mesh background
- Six pockets; one clear ID pocket; dual mic tabs

ITEM #	SIZE	COLOR	ITEM #	SIZE	COLOR
24133	S/M	HV Orange	24143	S/M	HV Lime
24135	L/XL	HV Orange	24145	L/XL	HV Lime
24137	2XL/3XL	HV Orange	24147	2XL/3XL	HV Lime
24139	4XL/5XL	HV Orange	24149	4XL/5XL	HV Lime



8248_Z



ORDER MULTIPLE
1

TYPE R CLASS 2 TWO-TONE SURVEYORS VEST



POCKETS

2 **4**

INNER OUTER

- ANSI-compliant polyester solid front / mesh back
- 2" ANSI-compliant reflective
- Reflective set on 3.5" contrasting background
- Zipper closure
- Six pockets; dual mic tabs

ITEM #	SIZE	COLOR	ITEM #	SIZE	COLOR
24063	S/M	HV Orange	24073	S/M	HV Lime
24065	L/XL	HV Orange	24075	L/XL	HV Lime
24067	2XL/3XL	HV Orange	24077	2XL/3XL	HV Lime
24069	4XL/5XL	HV Orange	24079	4XL/5XL	HV Lime



8249_Z



ORDER MULTIPLE
1

TYPE R CLASS 2 ECONOMY SURVEYORS VEST



POCKETS

2 **2**

INNER OUTER

- ANSI-compliant polyester solid front / mesh back
- 2" ANSI-compliant reflective
- Zipper closure
- Four pockets; single mic tab

ITEM #	SIZE	COLOR	ITEM #	SIZE	COLOR
24011	XS	HV Orange	24021	XS	HV Lime
24013	S/M	HV Orange	24023	S/M	HV Lime
24015	L/XL	HV Orange	24025	L/XL	HV Lime
24017	2XL/3XL	HV Orange	24027	2XL/3XL	HV Lime
24019	4XL/5XL	HV Orange	24029	4XL/5XL	HV Lime





8250_Z



ORDER MULTIPLE
1

TYPE R CLASS 2 SURVEYORS VEST



POCKETS

2 **4**

INNER OUTER

• REAR POCKET

- ANSI-compliant polyester solid front / mesh back
- 2" ANSI-compliant 3M™ Scotchlite™ Reflective
- Zipper closure
- Six pockets; dual mic tabs
- One large zippered rear document / tablet pocket

ITEM #	SIZE	COLOR	ITEM #	SIZE	COLOR
21413	S/M	HV Orange	21423	S/M	HV Lime
21415	L/XL	HV Orange	21425	L/XL	HV Lime
21417	2XL/3XL	HV Orange	21427	2XL/3XL	HV Lime
21419	4XL/5XL	HV Orange	21429	4XL/5XL	HV Lime





8250_{ZHG}



ORDER MULTIPLE
1

TYPE R CLASS 2 HI-GLOSS SURVEYORS VEST



POCKETS

2 **4**

INNER OUTER

• REAR POCKET

- ANSI-compliant polyester solid front / mesh back
- 2" ANSI-compliant 3M™ Scotchlite™ Reflective
- Zipper closure
- Six pockets; dual mic tabs
- One large zippered rear document / tablet pocket

ITEM #	SIZE	COLOR	ITEM #	SIZE	COLOR
21433	S/M	HV Orange	21435	L/XL	HV Orange
21437	2XL/3XL	HV Orange	21439	4XL/5XL	HV Orange



8253_{HDZ}



ORDER MULTIPLE
1

TYPE R CLASS 2 HEAVY-DUTY SURVEYORS MESH VEST

NEW FOR

'17



POCKETS

2 **4**

SIDE OUTER

• REAR POCKET

- ANSI-compliant polyester mesh (3.6oz)
- Zipper closure
- 2" ANSI-compliant reflective
- Lanyard grommet holes; structured webbing; mic tab
- Seven pockets; dual mic tabs

ITEM #	SIZE	COLOR	ITEM #	SIZE	COLOR
23313	S/M	HV Orange	23323	S/M	HV Lime
23315	L/XL	HV Orange	23325	L/XL	HV Lime
23317	2XL/3XL	HV Orange	23327	2XL/3XL	HV Lime
23319	4XL/5XL	HV Orange	23329	4XL/5XL	HV Lime

8254_{HDZ}

ORDER MULTIPLE
1

TYPE R CLASS 2 HEAVY-DUTY SURVEYORS VEST

POCKETS
2 / 4
SIDE OUTER
+ REAR POCKET

- ANSI-compliant polyester solid front / mesh back
- 2" ANSI-compliant 3M™ Scotchlite™ Reflective
- Reflective set on 3.5" contrasting background
- Heavy-duty #10 zipper closure
- Seven pockets; dual mic tabs

ITEM #	SIZE	COLOR
21453	S/M	HV Orange
21455	L/XL	HV Orange
21457	2XL/3XL	HV Orange
21459	4XL/5XL	HV Orange

8255_{HL}

ORDER MULTIPLE
1

TYPE R CLASS 2 TREATED POLYESTER VEST

POCKETS
1 / 0
INNER OUTER

- ANSI-compliant treated polyester solid
- After-flame treatment good for up to 25 washings
- 2" ANSI-compliant 3M™ Scotchlite™ FR Reflective
- Hook and loop closure
- One pocket

ITEM #	SIZE	COLOR
21473	S/M	HV Lime
21475	L/XL	HV Lime
21477	2XL/3XL	HV Lime
21479	4XL/5XL	HV Lime

8260_{FRHL}

ORDER MULTIPLE
1

TYPE R CLASS 2 FR MODACRYLIC VEST

FR

ATPV 4.6 CAL/CM²

NFPA 70E CAT 1

POCKETS
2 / 0
INNER OUTER

Flame resistant
ASTM F1506

- ANSI-compliant modacrylic mesh (5.6oz)
- ASTM F1506; ATPV of 4.6 cal/cm²
- 2" ANSI-compliant 3M™ Scotchlite™ FR Reflective
- FR hook and loop closure
- Two pockets; D-ring access slot; single mic tab

ITEM #	SIZE	COLOR	ITEM #	SIZE	COLOR
21493	S/M	HV Lime	21497	2XL/3XL	HV Lime
21495	L/XL	HV Lime	21499	4XL/5XL	HV Lime

8240_{HL/IC}

ORDER MULTIPLE
1

TYPE R CLASS 2 TWO-TONE EXPANDABLE VEST

POCKETS
1 / 0
INNER OUTER

- ANSI-compliant polyester mesh (3.3oz)
- 2" ANSI-compliant 3M™ Scotchlite™ Reflective
- Reflective set on 4.5" contrasting background
- Hook and loop closure
- One pocket; dual mic tabs

ITEM #	SIZE	COLOR	ITEM #	SIZE	COLOR
21380	M/L	White	21390	M/L	Navy
21382	XL/2XL	White	21392	XL/2XL	Navy
21384	M/L	HV Orange	21394	M/L	HV Lime
21386	XL/2XL	HV Orange	21396	XL/2XL	HV Lime

8244_{PSV}

ORDER MULTIPLE
1

TYPE P CLASS 2 EXPANDABLE PUBLIC SAFETY VEST

POCKETS
1 / 1
INNER OUTER

- ANSI-compliant polyester mesh (3.3oz)
- ANSI-compliant 3M™ Scotchlite™ Reflective
- Adjustable sides
- Hook and loop breakaway on shoulders and sides
- Two pockets; dual mic tabs

ITEM #	SIZE	COLOR	ITEM #	SIZE	COLOR
21360	M/L	HV Orange	21364	M/L	HV Lime
21362	XL/2XL	HV Orange	21366	XL/2XL	HV Lime
21363	3XL+	HV Orange	21367	3XL+	HV Lime

8245_{PSV}

ORDER MULTIPLE
1

TYPE P CLASS 2 PUBLIC SAFETY VEST

POCKETS
1 / 0
INNER OUTER

- ANSI-compliant poly solid front (3.6oz) / mesh back (3.3oz)
- Hook and loop breakaway on shoulders and sides
- ANSI-compliant 3M™ Scotchlite™ Reflective
- Reflective set on 4.5" contrasting background
- One multi-division pocket inside; dual mic tabs

ITEM #	SIZE	COLOR	ITEM #	SIZE	COLOR
23383	S/M	HV Orange	23393	S/M	HV Lime
23385	L/XL	HV Orange	23395	L/XL	HV Lime
23387	2XL/3XL	HV Orange	23397	2XL/3XL	HV Lime
23389	4XL/5XL	HV Orange	23399	4XL/5XL	HV Lime
23390	6XL/7XL	HV Orange	24000	6XL/7XL	HV Lime

GLOWEAR® HI-VIS APPAREL:

CLASS 3 SERIES

DIFFERENTIATED BY DESIGN

ANSI-COMPLIANT MATERIALS

GloWear® Hi-Vis Apparel is made of ANSI-compliant reflective and background materials to ensure the highest performance.

GARMENT DESIGN OPTIONS

Choose between zipper and hook and loop closures, mesh and solid fabrics, two-tone or not ... you've got options!



GLASS BEAD REFLECTIVE MATERIAL

Glass bead reflective tape meets the ANSI 107 standard and improves visibility of the worker.



8310_{HL}

ORDER MULTIPLE 1

TYPE R CLASS 3 ECONOMY MESH VEST



- ANSI-compliant polyester mesh (3.3oz)
- 2" ANSI-compliant reflective
- Hook and loop closure
- One pocket

ITEM #	SIZE	COLOR	ITEM #	SIZE	COLOR
22013	S/M	HV Orange	22023	S/M	HV Lime
22015	L/XL	HV Orange	22025	L/XL	HV Lime
22017	2XL/3XL	HV Orange	22027	2XL/3XL	HV Lime
22019	4XL/5XL	HV Orange	22029	4XL/5XL	HV Lime



8320_Z

ORDER MULTIPLE 1

TYPE R CLASS 3 STANDARD MESH VEST



- ANSI-compliant polyester mesh (3.3oz)
- 2" ANSI-compliant reflective
- Zipper closure
- Three pockets; single mic tab

ITEM #	SIZE	COLOR	ITEM #	SIZE	COLOR
22113	S/M	HV Orange	22123	S/M	HV Lime
22115	L/XL	HV Orange	22125	L/XL	HV Lime
22117	2XL/3XL	HV Orange	22127	2XL/3XL	HV Lime
22119	4XL/5XL	HV Orange	22129	4XL/5XL	HV Lime



8330_Z

ORDER MULTIPLE 1

TYPE R CLASS 3 TWO-TONE MESH VEST



- ANSI-compliant polyester mesh (3.3oz)
- 2" ANSI-compliant reflective
- Reflective set on 3.5" contrasting background
- Zipper closure
- One pocket; single mic tab

ITEM #	SIZE	COLOR	ITEM #	SIZE	COLOR
22173	S/M	HV Orange	22183	S/M	HV Lime
22175	L/XL	HV Orange	22185	L/XL	HV Lime
22177	2XL/3XL	HV Orange	22187	2XL/3XL	HV Lime
22179	4XL/5XL	HV Orange	22189	4XL/5XL	HV Lime



8356_{FRHL}

ORDER MULTIPLE 1

TYPE R CLASS 3 FR MODACRYLIC MESH VEST



NFPA 70E CAT 1
ATPV 4.6 CAL/CM²

Flame resistant
ASTM F1506



- ANSI-compliant modacrylic mesh (5.6oz)
- ASTM F1506; ATPV of 4.6 cal/cm²
- 2" ANSI-compliant 3M™ Scotchlite™ FR Reflective
- FR hook and loop closure
- Two pockets; D-ring access slot; single mic tab

ITEM #	SIZE	COLOR	ITEM #	SIZE	COLOR
22213	S/M	HV Lime	22217	2XL/3XL	HV Lime
22215	L/XL	HV Lime	22219	4XL/5XL	HV Lime

ANSI'S GENERAL THEORY OF CONSPICUITY

MUCH KNOWLEDGE IS
CONTAINED IN A SIMPLE
EQUATION: 2 + E = 3!

You can obtain Class 3 compliance in one of two ways. The most obvious is to buy an ANSI 107 Class 3 compliant garment. The less obvious—but more popular route—is to wear a Class 2 garment (usually a vest) and pair it with Class E compliant bottoms. Either way, you are clearly high class.

Type R
Class 2
8210HL



+

Supplemental
Class E
8910



=

Class 3

Type R
Class 2
8230Z



+

Supplemental
Class E
8911



=

Class 3

Type R
Class 3
8330Z



+

Supplemental
Class E
8911



=

Class 3



8910

ORDER
MULTIPLE
1

SUPPLEMENTAL CLASS E MESH PANTS



- ANSI-compliant polyester mesh (3.3oz)
- 2" ANSI-compliant reflective
- Drawstring waist; right leg cargo pocket
- Wide leg openings with hook and loop closures

ITEM #	SIZE	COLOR	ITEM #	SIZE	COLOR
22853	S/M	HV Orange	22953	S/M	HV Lime
22855	L/XL	HV Orange	22955	L/XL	HV Lime
22857	2XL/3XL	HV Orange	22957	2XL/3XL	HV Lime
22859	4XL/5XL	HV Orange	22959	4XL/5XL	HV Lime



8910_{BK}

ORDER
MULTIPLE
1

SUPPLEMENTAL CLASS E BLACK BOTTOM MESH PANTS



- ANSI-compliant polyester mesh (3.3oz)
- 2" ANSI-compliant reflective
- Drawstring waist; right leg cargo pocket
- Wide leg openings with hook and loop closures
- Black accents on bottom of leg high wear areas

ITEM #	SIZE	COLOR
23953	S/M	HV Lime
23955	L/XL	HV Lime
23957	2XL/3XL	HV Lime
23959	4XL/5XL	HV Lime



8911

ORDER
MULTIPLE
1

SUPPLEMENTAL CLASS E TWO-TONE MESH PANTS



- ANSI-compliant polyester mesh (3.3oz)
- 2" ANSI-compliant reflective
- Reflective set on 4.5" contrasting background
- Drawstring waist; right leg cargo pocket
- Wide leg openings with hook and loop closures

ITEM #	SIZE	COLOR	ITEM #	SIZE	COLOR
22863	S/M	HV Orange	22963	S/M	HV Lime
22865	L/XL	HV Orange	22965	L/XL	HV Lime
22867	2XL/3XL	HV Orange	22967	2XL/3XL	HV Lime
22869	4XL/5XL	HV Orange	22969	4XL/5XL	HV Lime



8008

ORDER
MULTIPLE
6

SUPPLEMENTAL CLASS E LEG GAITERS



- Weatherproof polyester shell with PU coating
- 2" ANSI-compliant 3M™ Scotchlite™ Reflective
- Drawstring closures on top and bottom

ITEM #	SIZE	COLOR
29081	—	HV Orange
29083	—	HV Lime

GLOWEAR® HI-VIS APPAREL:

SHIRT SERIES

DIFFERENTIATED BY DESIGN

MOISTURE WICKING TREATMENT

Wicking fabrics move moisture away, dry fast, and keep you comfortable in all temperatures.

COMPLIANT MATERIALS

GloWear® Hi-Vis Apparel is made of ANSI-compliant reflective and back-ground materials to ensure the highest performance.



HEAT TRANSFER REFLECTIVE MATERIAL

Every square inch meets the ANSI 107 standard, flexible heat transfer material for maximum comfort.

GARMENT DESIGN OPTIONS

With polyester breathable knits and polyester polar fleece, polos, T-shirts or sweatshirts, you've got options!

8289

ORDER MULTIPLE
1

TYPE R CLASS 2 T-SHIRT

POCKETS

0

INNER OUTER

- ANSI-compliant polyester breathable knit (4.1oz)
- 2" ANSI-compliant heat transfer reflective
- Moisture wicking treatment

ITEM #	SIZE	COLOR	ITEM #	SIZE	COLOR
21501	XS	HV Lime	21511	XS	HV Orange
21502	S	HV Lime	21512	S	HV Orange
21503	M	HV Lime	21513	M	HV Orange
21504	L	HV Lime	21514	L	HV Orange
21505	XL	HV Lime	21515	XL	HV Orange
21506	2XL	HV Lime	21516	2XL	HV Orange
21507	3XL	HV Lime	21517	3XL	HV Orange
21508	4XL	HV Lime	21518	4XL	HV Orange
21509	5XL	HV Lime	21519	5XL	HV Orange

8289_{BK}

ORDER MULTIPLE
1

TYPE R CLASS 2 BLACK FRONT T-SHIRT

POCKETS

0

INNER OUTER

- ANSI-compliant polyester breathable knit (4.1oz)
- 2" ANSI-compliant heat transfer reflective
- Moisture wicking treatment

ITEM #	SIZE	COLOR	ITEM #	SIZE	COLOR
22502	S	HV Lime	22512	S	HV Orange
22503	M	HV Lime	22513	M	HV Orange
22504	L	HV Lime	22514	L	HV Orange
22505	XL	HV Lime	22515	XL	HV Orange
22506	2XL	HV Lime	22516	2XL	HV Orange
22507	3XL	HV Lime	22517	3XL	HV Orange
22508	4XL	HV Lime	22518	4XL	HV Orange
22509	5XL	HV Lime	22519	5XL	HV Orange



FIND OUT MORE ABOUT THE TECHNOLOGY THAT GOES INTO THE FULL LINE OF ERGODYNE HI-VIS APPAREL AT: WWW.ERGODYNE.COM

8280BK

ORDER MULTIPLE
1

TYPE R CLASS 2 BLACK FRONT PERFORMANCE SHORT SLEEVE T-SHIRT

POCKETS
01
INNER OUTER

NEW FOR '17

- ANSI-compliant polyester breathable knit (4.1oz)
- Moisture wicking treatment
- 2" ANSI-compliant 3M™ Scotchlite™ Comfort Trim

ITEM #	SIZE	COLOR	ITEM #	SIZE	COLOR
22532	S	HV Lime	22582	S	HV Orange
22533	M	HV Lime	22583	M	HV Orange
22534	L	HV Lime	22584	L	HV Orange
22535	XL	HV Lime	22585	XL	HV Orange
22536	2XL	HV Lime	22586	2XL	HV Orange
22537	3XL	HV Lime	22587	3XL	HV Orange
22538	4XL	HV Lime	22588	4XL	HV Orange
22539	5XL	HV Lime	22589	5XL	HV Orange

8295

ORDER MULTIPLE
1

TYPE R CLASS 2 POLO SHIRT

POCKETS
01
INNER OUTER

- ANSI-compliant polyester breathable knit (4.1oz)
- 2" ANSI-compliant heat transfer reflective
- Moisture wicking treatment
- Split tail hem
- One outside chest pocket

ITEM #	SIZE	COLOR	ITEM #	SIZE	COLOR
21642	S	HV Lime	21646	2XL	HV Lime
21643	M	HV Lime	21647	3XL	HV Lime
21644	L	HV Lime	21648	4XL	HV Lime
21645	XL	HV Lime	21649	5XL	HV Lime

8089

ORDER MULTIPLE
1

NON-CERTIFIED T-SHIRT

POCKETS
01
INNER OUTER

- Polyester breathable knit (4.1oz)
- Moisture wicking treatment

ITEM #	SIZE	COLOR	ITEM #	SIZE	COLOR
21552	S	HV Lime	21562	S	HV Orange
21553	M	HV Lime	21563	M	HV Orange
21554	L	HV Lime	21564	L	HV Orange
21555	XL	HV Lime	21565	XL	HV Orange
21556	2XL	HV Lime	21566	2XL	HV Orange
21557	3XL	HV Lime	21567	3XL	HV Orange
21558	4XL	HV Lime	21568	4XL	HV Orange
21559	5XL	HV Lime	21569	5XL	HV Orange

8091

ORDER MULTIPLE
1

NON-CERTIFIED LONG SLEEVE T-SHIRT

POCKETS
01
INNER OUTER

- Polyester breathable knit (4.1oz)
- Moisture wicking treatment

ITEM #	SIZE	COLOR	ITEM #	SIZE	COLOR
21582	S	HV Lime	21592	S	HV Orange
21583	M	HV Lime	21593	M	HV Orange
21584	L	HV Lime	21594	L	HV Orange
21585	XL	HV Lime	21595	XL	HV Orange
21586	2XL	HV Lime	21596	2XL	HV Orange
21587	3XL	HV Lime	21597	3XL	HV Orange
21588	4XL	HV Lime	21598	4XL	HV Orange
21589	5XL	HV Lime	21599	5XL	HV Orange

8291BK

ORDER MULTIPLE
1

TYPE R CLASS 2 BLACK FRONT LONG SLEEVE T-SHIRT

POCKETS
01
INNER OUTER

- ANSI-compliant polyester breathable knit (4.1oz)
- 2" ANSI-compliant heat transfer reflective
- Moisture wicking treatment

ITEM #	SIZE	COLOR	ITEM #	SIZE	COLOR
22702	S	HV Lime	22712	S	HV Orange
22703	M	HV Lime	22713	M	HV Orange
22704	L	HV Lime	22714	L	HV Orange
22705	XL	HV Lime	22715	XL	HV Orange
22706	2XL	HV Lime	22716	2XL	HV Orange
22707	3XL	HV Lime	22717	3XL	HV Orange
22708	4XL	HV Lime	22718	4XL	HV Orange
22709	5XL	HV Lime	22719	5XL	HV Orange

8281BK

ORDER MULTIPLE
1

TYPE R CLASS 2 BLACK FRONT PERFORMANCE LONG SLEEVE T-SHIRT

POCKETS
01
INNER OUTER

NEW FOR '17

- ANSI-compliant polyester breathable knit (4.1oz)
- Moisture wicking treatment
- 2" ANSI-compliant 3M™ Scotchlite™ Comfort Trim

ITEM #	SIZE	COLOR	ITEM #	SIZE	COLOR
22632	S	HV Lime	22682	S	HV Orange
22633	M	HV Lime	22683	M	HV Orange
22634	L	HV Lime	22684	L	HV Orange
22635	XL	HV Lime	22685	XL	HV Orange
22636	2XL	HV Lime	22686	2XL	HV Orange
22637	3XL	HV Lime	22687	3XL	HV Orange
22638	4XL	HV Lime	22688	4XL	HV Orange
22639	5XL	HV Lime	22689	5XL	HV Orange



8391

ORDER MULTIPLE
1

TYPE R CLASS 3 LONG SLEEVE T-SHIRT

POCKETS
01
INNER OUTER



- ANSI-compliant polyester breathable knit (4.1oz)
- 2" ANSI-compliant heat transfer reflective
- Moisture wicking treatment

ITEM #	SIZE	COLOR	ITEM #	SIZE	COLOR
21702	S	HV Lime	21712	S	HV Orange
21703	M	HV Lime	21713	M	HV Orange
21704	L	HV Lime	21714	L	HV Orange
21705	XL	HV Lime	21715	XL	HV Orange
21706	2XL	HV Lime	21716	2XL	HV Orange
21707	3XL	HV Lime	21717	3X	HV Orange
21708	4XL	HV Lime	21718	4XL	HV Orange
21709	5XL	HV Lime	21719	5X	HV Orange



8397

ORDER MULTIPLE
1

TYPE R CLASS 3 CREW NECK SWEATSHIRT



- ANSI-compliant polyester polar fleece (8oz)
- 2" ANSI-compliant heat transfer reflective
- Crew neck design

ITEM #	SIZE	COLOR	ITEM #	SIZE	COLOR
21672	S	HV Lime	21676	2XL	HV Lime
21673	M	HV Lime	21677	3XL	HV Lime
21674	L	HV Lime	21678	4XL	HV Lime
21675	XL	HV Lime	21679	5XL	HV Lime

OFFICIAL PRODUCT REVIEW



unscripted • unbiased • unabashed

TESTER: ANTHONY GERMANA

PRODUCT: 8393

“Great sweatshirt. Holds up under harsh material like rebar, large electrical conduit, etc. I had a lot of mobility also the temperature fluctuated each day and I was comfortable. All the other trades asked me about the clothes and where to get them. I would recommend this sweatshirt to any and all trades.”

ONE WORD REVIEW: COMFORTABLE



8293

ORDER MULTIPLE
1

TYPE R CLASS 2 BLACK FRONT HOODED SWEATSHIRT

POCKETS
01
INNER OUTER



- ANSI-compliant polyester polar fleece (8oz)
- 2" ANSI-compliant heat transfer reflective
- Black accents on front and sleeve: high-wear areas
- Drawstring hood
- Front pouch-style pocket

ITEM #	SIZE	COLOR	ITEM #	SIZE	COLOR
21682	S	HV Lime	21686	2XL	HV Lime
21683	M	HV Lime	21687	3XL	HV Lime
21684	L	HV Lime	21688	4XL	HV Lime
21685	XL	HV Lime	21689	5XL	HV Lime



8393

ORDER MULTIPLE
1

TYPE R CLASS 3 HOODED SWEATSHIRT

POCKETS
01
INNER OUTER



- ANSI-compliant polyester polar fleece (8oz)
- 2" ANSI-compliant heat transfer reflective

ITEM #	SIZE	COLOR	ITEM #	SIZE	COLOR
21762	S	HV Lime	21772	S	HV Orange
21763	M	HV Lime	21773	M	HV Orange
21764	L	HV Lime	21774	L	HV Orange
21765	XL	HV Lime	21775	XL	HV Orange
21766	2XL	HV Lime	21776	2XL	HV Orange
21767	3XL	HV Lime	21777	3XL	HV Orange
21768	4XL	HV Lime	21778	4XL	HV Orange
21769	5XL	HV Lime	21779	5XL	HV Orange



8392

ORDER MULTIPLE
1

TYPE R CLASS 3 FULL-ZIP HOODED SWEATSHIRT

POCKETS
02
INNER OUTER



- ANSI-compliant polyester polar fleece (8oz)
- 2" ANSI-compliant heat transfer reflective

ITEM #	SIZE	COLOR	ITEM #	SIZE	COLOR
21742	S	HV Lime	21752	S	HV Orange
21743	M	HV Lime	21753	M	HV Orange
21744	L	HV Lime	21754	L	HV Orange
21745	XL	HV Lime	21755	XL	HV Orange
21746	2XL	HV Lime	21756	2XL	HV Orange
21747	3XL	HV Lime	21757	3XL	HV Orange
21748	4XL	HV Lime	21758	4XL	HV Orange
21749	5XL	HV Lime	21759	5XL	HV Orange

	8010_{HL}	ORDER MULTIPLE 1
--	--------------------------	----------------------------

NON-CERTIFIED ECONOMY VEST

- Polyester mesh (2.6oz)
- Hook and loop closure

ITEM #	SIZE	COLOR
20010	—	HV Orange
20020	—	HV Lime

	8020_{HL}	ORDER MULTIPLE 1
--	--------------------------	----------------------------

NON-CERTIFIED STANDARD VEST

- Polyester mesh (2.6oz)
- 1" reflective
- Hook and loop closure

ITEM #	SIZE	COLOR
20030	—	HV Orange
20040	—	HV Lime

	8040_{HL}	ORDER MULTIPLE 1
--	--------------------------	----------------------------

NON-CERTIFIED HI-GLOSS VEST

- Polyester mesh (2.6oz)
- 1" hi-gloss reflective
- Hook and loop closure

ITEM #	SIZE	COLOR
20070	—	HV Orange
20080	—	HV Lime

	8080_{BAX}	ORDER MULTIPLE 1
--	---------------------------	----------------------------

NON-CERTIFIED X-BACK VEST

- Polyester mesh (2.6oz)
- 2" hi-gloss reflective
- Hook and loop closure
- Breakaway shoulders

ITEM #	SIZE	COLOR
26030	—	HV Orange
26040	—	HV Lime

	8140_{BA}	ORDER MULTIPLE 1
--	--------------------------	----------------------------

TYPE O BREAKAWAY SASH

- ANSI-compliant oxford polyester
- 1.375" ANSI-compliant 3M™ Scotchlite™ Reflective
- X-back design
- Breakaway shoulders and sides
- One pocket

ITEM #	SIZE	COLOR
27014	M/L	HV Lime
27015	XL/2XL	HV Lime
27016	3XL*	HV Lime
27017	M/L	HV Orange
27018	XL/2XL	HV Orange
27019	3XL*	HV Orange

MAKE IT CUSTOM!

HERE'S THE DRILL: CUSTOM LOGO PROGRAM



Because we have so many options and styles of products available to custom logo, we can do almost anything.

YOU GIVE US:

- Suitable digital art files or camera-ready artwork. (EPS-format files work best but large, hi-res TIF or JPG files [300+ dpi] work too.)
- All necessary PMS/Pantone colors.
- Approval of a digital mock-up.

WE GIVE YOU: A product with a look all your own.

Minimums vary based on the type of product. Don't worry, it's low.

Call Ergodyne Customer Support today to answer all of your custom logo questions ... We'll make it easy for you to look good!

GLOWEAR® HI-VIS APPAREL:

FOUL WEATHER SERIES

DIFFERENTIATED BY DESIGN



8385 4-IN-1 JACKET

COMPLIANT MATERIALS

GloWear® Hi-Vis Apparel is made of ANSI-compliant reflective and background materials to ensure the highest performance.

3M™ SCOTCHLITE™ REFLECTIVE

3M™ Scotchlite™ glass bead reflective tape meets the ANSI 107 standard and improves visibility of the worker.

BREATHABLE PU COATING

Breathable PU poly shell keeps water out while letting perspiration escape for warm, dry comfort.

VERSATILITY

GloWear® Hi-Vis Apparel is made with flexibility and versatility in mind. 4-in-1 jackets allow you to dress for the weather.



CLASS 3 WEATHERPROOF THERMAL JACKET



CLASS 3 WEATHERPROOF RAIN JACKET



CLASS 2 THERMAL JACKET



CLASS 2 THERMAL VEST



FIND OUT MORE ABOUT THE TECHNOLOGY THAT GOES INTO THE FULL LINE OF ERGODYNE HI-VIS APPAREL AT: WWW.ERGODYNE.COM

TYPE R CLASS 3 QUILTED BOMBER JACKET

ANSI COMPLIANT

8377 ORDER MULTIPLE **1**

NEW FOR '17

POCKETS 1 3
INNER OUTER

- Weatherproof 300D oxford outer shell
- Breathable PU coating
- Fully lined with 160g thermal quilted insulation
- 2" ANSI-compliant reflective material
- Black accents on front and high wear sleeve areas
- Inset hood with drawstring and stoppers
- Dual slot pen pocket on arm

ITEM #	SIZE	COLOR
25622	S	HV Lime
25623	M	HV Lime
25624	L	HV Lime
25625	XL	HV Lime
25626	2XL	HV Lime
25627	3XL	HV Lime
25628	4XL	HV Lime
25629	5XL	HV Lime

TYPE R CLASS 3 FLEECE LINED BOMBER JACKET

ANSI COMPLIANT

8379 ORDER MULTIPLE **1**

UPDATED FOR '17

POCKETS 1 3
INNER OUTER

- Weatherproof 100% polyester outer shell
- Breathable PU coating
- Zip-out 220g microfleece liner
- 2" ANSI-compliant reflective material
- Black accents on high wear areas
- Detachable inset hood with drawstring and stoppers
- Dual slot pen pocket on arm

ITEM #	SIZE	COLOR	ITEM #	SIZE	COLOR
24472	S	HV Lime	24462	S	HV Orange
24473	M	HV Lime	24463	M	HV Orange
24474	L	HV Lime	24464	L	HV Orange
24475	XL	HV Lime	24465	XL	HV Orange
24476	2XL	HV Lime	24466	2XL	HV Orange
24477	3XL	HV Lime	24467	3XL	HV Orange
24478	4XL	HV Lime	24468	4XL	HV Orange
24479	5XL	HV Lime	24469	5XL	HV Orange

TYPE R CLASS 3 BOMBER JACKET

ANSI COMPLIANT 3M

8380 ORDER MULTIPLE **1**

POCKETS 0 3
INNER OUTER

- Weatherproof 300D oxford outer shell
- Breathable PU coating
- Inner jacket with 300g fleece lining
- 2" ANSI-compliant 3M™ Scotchlite™ Reflective
- Inset hood with drawstring and stoppers

ITEM #	SIZE	COLOR	ITEM #	SIZE	COLOR
24492	S	HV Lime	24482	S	HV Orange
24493	M	HV Lime	24483	M	HV Orange
24494	L	HV Lime	24484	L	HV Orange
24495	XL	HV Lime	24485	XL	HV Orange
24496	2XL	HV Lime	24486	2XL	HV Orange
24497	3XL	HV Lime	24487	3XL	HV Orange
24498	4XL	HV Lime	24488	4XL	HV Orange
24499	5XL	HV Lime	24489	5XL	HV Orange



8365

ORDER MULTIPLE

1

TYPE R CLASS 3 RAIN JACKET



POCKETS
0 3
INNER OUTER

- Weatherproof 300D oxford outer shell
- Breathable PU coating, polyester mesh lining
- 2" ANSI-compliant 3M™ Scotchlite™ Reflective
- Dual mic tabs

ITEM #	SIZE	COLOR	ITEM #	SIZE	COLOR
24322	S	HV Lime	24312	S	HV Orange
24323	M	HV Lime	24313	M	HV Orange
24324	L	HV Lime	24314	L	HV Orange
24325	XL	HV Lime	24315	XL	HV Orange
24326	2XL	HV Lime	24316	2XL	HV Orange
24327	3XL	HV Lime	24317	3XL	HV Orange
24328	4XL	HV Lime	24318	4XL	HV Orange
24329	5XL	HV Lime	24319	5XL	HV Orange



8365_{BK}

ORDER MULTIPLE

1

TYPE R CLASS 3 BLACK FRONT RAIN JACKET



POCKETS
0 3
INNER OUTER

- Weatherproof 300D oxford outer shell
- Breathable PU coating, polyester mesh lining
- 2" ANSI-compliant 3M™ Scotchlite™ Reflective
- Black accents on front and sleeve: high-wear areas
- Dual mic tabs

ITEM #	SIZE	COLOR	ITEM #	SIZE	COLOR
25322	S	HV Lime	25326	2XL	HV Lime
25323	M	HV Lime	25327	3XL	HV Lime
25324	L	HV Lime	25328	4XL	HV Lime
25325	XL	HV Lime	25329	5XL	HV Lime



8385

ORDER MULTIPLE

1

TYPE R CLASS 3 4-IN-1 JACKET



POCKETS
2 3
INNER OUTER

UPDATED FOR
'17

- Weatherproof 300D oxford outer shell
- Breathable PU coating
- Inner jacket with 100g 3M™ Thinsulate™ lining
- 2" ANSI-compliant 3M™ Scotchlite™ Reflective

ITEM #	SIZE	COLOR	ITEM #	SIZE	COLOR
24382	S	HV Lime	24372	S	HV Orange
24383	M	HV Lime	24373	M	HV Orange
24384	L	HV Lime	24374	L	HV Orange
24385	XL	HV Lime	24375	XL	HV Orange
24386	2XL	HV Lime	24376	2XL	HV Orange
24387	3XL	HV Lime	24377	3XL	HV Orange
24388	4XL	HV Lime	24378	4XL	HV Orange
24389	5XL	HV Lime	24379	5XL	HV Orange



8386

ORDER MULTIPLE

1

TYPE R CLASS 3 OUTER SHELL JACKET



POCKETS
0 4
INNER OUTER

NEW FOR
'17

- Weatherproof 300D oxford outer shell
- Breathable PU coating, polyester mesh lining
- 2" ANSI-compliant 3M™ Scotchlite™ Reflective

ITEM #	SIZE	COLOR	ITEM #	SIZE	COLOR
25372	S	HV Lime	25462	S	HV Orange
25373	M	HV Lime	25463	M	HV Orange
25374	L	HV Lime	25464	L	HV Orange
25375	XL	HV Lime	25465	XL	HV Orange
25376	2XL	HV Lime	25466	2XL	HV Orange
25377	3XL	HV Lime	25467	3XL	HV Orange
25378	4XL	HV Lime	25468	4XL	HV Orange
25379	5XL	HV Lime	25469	5XL	HV Orange



8287

ORDER MULTIPLE

1

TYPE R CLASS 2 CONVERTIBLE THERMAL JACKET



POCKETS
0 3
INNER OUTER

NEW FOR
'17

- Weatherproof 300D oxford outer shell
- 3M™ Thinsulate™ Insulation thermal lining
- 2" ANSI-compliant 3M™ Scotchlite™ Reflective

ITEM #	SIZE	COLOR	ITEM #	SIZE	COLOR
25492	S	HV Lime	25512	S	HV Orange
25493	M	HV Lime	25513	M	HV Orange
25494	L	HV Lime	25514	L	HV Orange
25495	XL	HV Lime	25515	XL	HV Orange
25496	2XL	HV Lime	25516	2XL	HV Orange
25497	3XL	HV Lime	25517	3XL	HV Orange
25498	4XL	HV Lime	25518	4XL	HV Orange
25499	5XL	HV Lime	25519	5XL	HV Orange



8388

ORDER MULTIPLE

1

TYPE R CLASS 3/2 THERMAL JACKET KIT



POCKETS
2 4
INNER OUTER

NEW FOR
'17

- Combines 8386 Outer Shell and 8287 Thermal jacket
- Weatherproof 300D oxford outer shell
- 3M™ Thinsulate™ Insulation thermal lining

ITEM #	SIZE	COLOR	ITEM #	SIZE	COLOR
25532	S	HV Lime	25552	S	HV Orange
25533	M	HV Lime	25553	M	HV Orange
25534	L	HV Lime	25554	L	HV Orange
25535	XL	HV Lime	25555	XL	HV Orange
25536	2XL	HV Lime	25556	2XL	HV Orange
25537	3XL	HV Lime	25557	3XL	HV Orange
25538	4XL	HV Lime	25558	4XL	HV Orange
25539	5XL	HV Lime	25559	5XL	HV Orange

OFFICIAL PRODUCT REVIEW

TENACIOUS TESTER™ APPROVED

unscripted • unbiased • unabashed

TESTER: TYLER BORTZ

PRODUCT: **8365BK**

“This rain jacket is one of the best jackets I have every used. I have used this jacket in light mist situations to heavy down pours and it keeps me dry. This jacket even works well if the weather is just a bit cool and you need something to keep the chill out. Overall this jacket is very nice and is a great addition to keep in the truck in case the weather takes a turn for the worst. Good work Ergodyne!”

ONE WORD REVIEW: **DRY**

ANSI 3M

8915 ORDER MULTIPLE 1

SUPPLEMENTAL CLASS E RAIN PANTS

- Weatherproof 300D oxford outer shell
- Breathable PU coating
- 2" ANSI-compliant 3M™ Scotchlite™ Reflective
- Elastic waistband; right leg cargo pocket
- Zippered leg openings for easy on/off

ITEM #	SIZE	COLOR	ITEM #	SIZE	COLOR
24422	S	HV Lime	24412	S	HV Orange
24423	M	HV Lime	24413	M	HV Orange
24424	L	HV Lime	24414	L	HV Orange
24425	XL	HV Lime	24415	XL	HV Orange
24426	2XL	HV Lime	24416	2XL	HV Orange
24427	3XL	HV Lime	24417	3XL	HV Orange
24428	4XL	HV Lime	24418	4XL	HV Orange
24429	5XL	HV Lime	24419	5XL	HV Orange

ANSI 3M

8915^{BK} ORDER MULTIPLE 1

SUPPLEMENTAL CLASS E BLACK BOTTOM RAIN PANTS

- Weatherproof 300D oxford outer shell
- Breathable PU coating
- 2" ANSI-compliant 3M™ Scotchlite™ Reflective
- Elastic waistband; right leg cargo pocket
- Black accents on leg; high-wear areas

ITEM #	SIZE	COLOR	ITEM #	SIZE	COLOR
25422	S	HV Lime	25426	2XL	HV Lime
25423	M	HV Lime	25427	3XL	HV Lime
25424	L	HV Lime	25428	4XL	HV Lime
25425	XL	HV Lime	25429	5XL	HV Lime

MAKE IT CUSTOM!

HERE'S THE DRILL: CUSTOM LOGO PROGRAM



Because we have so many options and styles of products available to custom logo, we can do almost anything.

YOU GIVE US:

- Suitable digital art files or camera-ready artwork. (EPS-format files work best but large, hi-res TIF or JPG files [300+ dpi] work too.)
- All necessary PMS/Pantone colors.
- Approval of a digital mock-up.

WE GIVE YOU: A product with a look all your own.

Minimums vary based on the type of product. Don't worry, it's low.

Call Ergodyne Customer Support today to answer all of your custom logo questions ... We'll make it easy for you to look good!

ANSI 3M

8918^{BK} ORDER MULTIPLE 1

SUPPLEMENTAL CLASS E BLACK BOTTOM RAIN BIBS

- Weatherproof 300D oxford outer shell
- Breathable PU coating
- 2" ANSI-compliant 3M™ Scotchlite™ Reflective
- Adjustable elastic suspenders; right cargo pocket
- Black accents on leg; high-wear areas

ITEM #	SIZE	COLOR	ITEM #	SIZE	COLOR
25012	S	HV Lime	25016	2XL	HV Lime
25013	M	HV Lime	25017	3XL	HV Lime
25014	L	HV Lime	25018	4XL	HV Lime
25015	XL	HV Lime	25019	5XL	HV Lime

ANSI 3M

8925 ORDER MULTIPLE 1

SUPPLEMENTAL CLASS E THERMAL PANTS

- Weatherproof 100% polyester outer shell
- Breathable PU coating
- 80g 3M™ Thinsulate™ lining
- 2" ANSI-compliant 3M™ Scotchlite™ Reflective
- Elastic waistband; right leg cargo pocket

ITEM #	SIZE	COLOR	ITEM #	SIZE	COLOR
24452	S	HV Lime	24442	S	HV Orange
24453	M	HV Lime	24443	M	HV Orange
24454	L	HV Lime	24444	L	HV Orange
24455	XL	HV Lime	24445	XL	HV Orange
24456	2XL	HV Lime	24446	2XL	HV Orange
24457	3XL	HV Lime	24447	3XL	HV Orange
24458	4XL	HV Lime	24448	4XL	HV Orange
24459	5XL	HV Lime	24449	5XL	HV Orange

GLOWEAR® HI-VIS APPAREL:

HEADWEAR & ACCESSORIES SERIES

DIFFERENTIATED BY DESIGN

COMPLIANT MATERIALS

GloWear® Hi-Vis Apparel is made of ANSI-compliant reflective and background materials to ensure the highest performance.

MESH VENTING

360° ventilated panels allow air to better circulate - cool your melon!



GLASS BEAD REFLECTIVE MATERIAL

Glass bead reflective tape meets the ANSI 107 standard and improves your visibility.

HEADWEAR DESIGN OPTIONS

Baseball cap or ranger hat, lime, or orange - you have options!

			8935			ORDER MULTIPLE	
						1	
HI-VIS RANGER HAT							
<ul style="list-style-type: none"> • 150D oxford polyester • Mesh venting panels • 1" ANSI-compliant reflective • Three sizes: S/M (21-22.5"), L/XL (22.5-24"), 2XL/3XL (24-25.5") 							
ITEM #	SIZE	COLOR	ITEM #	SIZE	COLOR		
23259	S/M	HV Lime	23257	S/M	HV Orange		
23260	L/XL	HV Lime	23258	L/XL	HV Orange		
23261	2XL/3XL	HV Lime	23262	2XL/3XL	HV Orange		

8935



FIND OUT MORE ABOUT THE TECHNOLOGY THAT GOES INTO THE FULL LINE OF ERGODYNE HI-VIS APPAREL AT: WWW.ERGODYNE.COM

	8930	ORDER MULTIPLE 1
HI-VIS BASEBALL CAP		
		
<ul style="list-style-type: none"> • 150D oxford polyester • Mesh venting panels • ANSI-compliant reflective material 		
ITEM #	SIZE	COLOR
23238	—	HV Orange
23239	—	HV Lime

	8004	ORDER MULTIPLE 6
HI-VIS SEAT BELT COVER		
		
<ul style="list-style-type: none"> • ANSI-compliant polyester solid fabric (3.6oz) • 2" ANSI-compliant reflective • Hook and loop closures • Fits standard width seat belt harness • 5½" open; 2" closed 		
ITEM #	SIZE	COLOR
29041	—	HV Orange
29043	—	HV Lime

	8005	ORDER MULTIPLE 1
HI-VIS MESH NECK SHADE		
		
<ul style="list-style-type: none"> • ANSI-compliant polyester mesh (3.3oz) • ANSI-compliant reflective material • Reflective set on contrasting background • Elastic band fits most hard hats • Plastic clips to secure in place 		
ITEM #	SIZE	COLOR
29051	—	HV Orange
29053	—	HV Lime

	8006	ORDER MULTIPLE 6
HI-VIS NECK SHADE		
		
<ul style="list-style-type: none"> • ANSI-compliant polyester solid fabric (3.6oz) • Reflective binding • Hook and loop closures • Attaches to hard hat suspension headbands 		
ITEM #	SIZE	COLOR
29061	—	HV Orange
29063	—	HV Lime

	8003	ORDER MULTIPLE 12
ARM/LEG BAND - BUCKLE		
		
<ul style="list-style-type: none"> • Woven elastic band • ANSI-compliant 3M™ Scotchlite™ Reflective • Adjusts from 13" to 16" • 1" wide 		
ITEM #	SIZE	COLOR
29031	—	HV Orange
29033	—	HV Lime

	8001	ORDER MULTIPLE 12			
ARM/LEG BAND - SNAP					
					
<ul style="list-style-type: none"> • Knit elastic band • ANSI-compliant 3M™ Scotchlite™ Reflective • Two sizes: S/M (12"), L/XL (15") • 2" wide 					
ITEM #	SIZE	COLOR	ITEM #	SIZE	COLOR
29013	S/M	HV Lime	29011	S/M	HV Orange
29014	L/XL	HV Lime	29012	L/XL	HV Orange



SKULLERZ®
EYE PROTECTION

**MILITARY INSPIRED.
WORKPLACE REQUIRED.
WEEKEND DESIRED.**



SKULLERZ® EYE PROTECTION

Triple threat? Happens every day, usually before lunch. Triple compliance? Certainly not your ordinary eye protection. Norse God-named, full- or half-framed, our sweet Skullerz® Safety Glasses have your back from workplace to weekend and everywhere in-between – with ANSI compliance across the board, MIL-PRF ballistic impact protection that comes standard, and CSA compliance on a full five models. Each one boasts UV protection, scratch resistance, lightweight frames, and a host of condition-specific lenses. With options for inherent, permanent Fog-Off™ anti-fog technology or polarized premium lenses to reduce glare, you now have eye protection that works as hard as you do. Your move, James Brown.

EYE PROTECTION // SERIES LEVEL



ODIN Safety Glasses



THOR Safety Glasses



DAGR Safety Glasses



BALDR Safety Glasses



KVASIR Safety Glasses



VALKYRIE Safety Glasses



ERDA Safety Glasses



NJORD Safety Glasses



LOKI Safety Glasses/Goggles



TYR Safety Glasses

EYE PROTECTION // ACCESSORY SERIES



3200 Cotton Lanyard



3215 Breakaway Cotton Lanyard



3251 Breakaway Rope Lanyard



3275 Neoprene Lanyard



3280 Coil Lanyard



Gasket & Elastic Strap

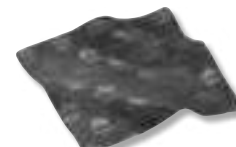

3216 Microfiber Cleaning Cloth



3218 Microfiber Cleaning Bag



3222 Zipper Case w/ Clip



3225 Ballistic Zipper Case



SKULLERZ
EYE & HEAD
PROTECTION



MIL-PRF 32432
Impact Steel Projectile

ANSI Z87.1+
Impact Steel Ball

IMPACT: HOW FAST IS FAST?

Another day at battle is always unpredictable and might be full of the slings and arrows of outrageous fortune. Whatever the job throws, shoots, or flings, it's essential to be ready for action. Luckily, you chose Skullerz® Eye Protection. From dangerous tools to everyday dust and debris, you can count on Skullerz® Safety Glasses for tested, proven protection. We'd still watch out for that rogue barbarian though.

Pneumatic Nail Gun	490 ft. // 149m sec
Nolan Ryan Fastball	148 ft. // 45m sec
Catapult	843 ft. // 257m sec

SKULLERZ® EYE PROTECTION:

THE ANATOMY OF EYE DEFENSE.

DIFFERENTIATED BY DESIGN

When you're on the job, there's no time to wonder if your specs meet the specs. All Skullerz® Safety Glasses are third-party tested to meet ANSI Z87.1, the U.S. eye protection standard, and marked with a "+" to denote High Velocity Impact Protection. Select Skullerz® also meet the requirements of CSA Z94.3, Canada's national standard for eye protection. CSA compliance requires spectacles to have slightly more coverage than those meeting only ANSI Z87.1+.

Because sometimes the workzone can feel more like a warzone, all Skullerz® Safety Glasses also meet U.S. MIL-PRF 32432 Ballistic Impact Protection requirements. This test requires protection from a high velocity impact of more than 4X what ANSI or CSA mandates. Stand and deliver.

TESTED TO THE FOLLOWING STANDARDS:

// ANSI Z87.1+

// CSA Z94.3
Select Models// MIL-PRF 32432
BALLISTIC IMPACT**TESTED ON DUMMIES BECAUSE YOU AREN'T ONE.**

All Skullerz® models are independently third-party tested at COLTS Laboratories.

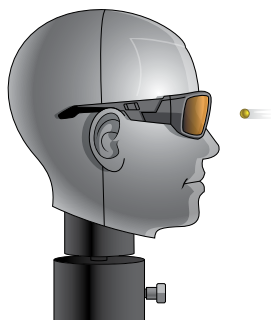

COLTS | Laboratories™

**High Velocity Impact Test**
Simulates Flying Debris

ANSI Z87.1+:	150 ft./sec
CSA Z94.3:	46.5 m/sec
MIL-PRF 32432:	660 ft./sec // 201m/sec

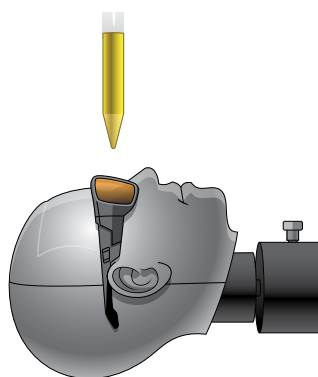
**High Mass Impact Test**
Simulates Blunt Force

ANSI Z87.1+:	18 oz. steel missile dropped from 50 in.
CSA Z94.3:	—
MIL-PRF 32432:	Follows ANSI Z87.1+

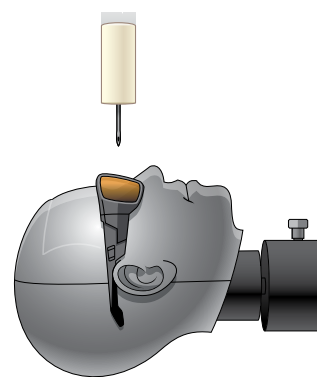
**Penetration Resistance Test**
Simulates a Poke in the Eye

ANSI Z87.1+:	Weighted needle dropped from 50 in.
CSA Z94.3:	—
MIL-PRF 32432:	Follows ANSI Z87.1+

IN ALL TEST SCENARIOS FOR ALL STANDARDS, LENSES AND FRAMES MUST STAY INTACT AND NOT BREAK OR SHATTER.



**SKULLERZ®
FRAME OPTIONS**

Ergodyne Skullerz® Safety Glasses are available in a variety of frame color options to perfectly suit your jobsite style. See the specific model for frame availability. Choose from:



FRAME: **BLACK**
AVAILABLE ON:
ODIN, THOR, DAGR, KVASIR, VALKYRIE,
NJORD, LOKI, BALDR, ERDA



FRAME: **MATTE BLACK**
AVAILABLE ON:
ODIN, TYR



FRAME: **MATTE GRAY**
AVAILABLE ON:
ODIN, THOR, DAGR, KVASIR, VALKYRIE,
NJORD, LOKI, BALDR



FRAME: **WHITE**
AVAILABLE ON:
ODIN, ERDA



FRAME: **KRYPTEK® YETI™ CAMO**
AVAILABLE ON:
DAGR, ERDA



FRAME: **KRYPTEK® HIGHLANDER™ CAMO**
AVAILABLE ON:
ODIN, DAGR, BALDR



FRAME: **KRYPTEK® TYPHON™ CAMO**
AVAILABLE ON:
ODIN, THOR, DAGR, BALDR, ERDA

**SKULLERZ®
LENS OPTIONS**

Ergodyne Skullerz® Safety Glasses are available in a variety of lens options ideally suited for a variety of tasks and light environments. See the specific model for lens availability. Choose from:



LENS: **CLEAR //
CLEAR FOG-OFF™**
VLT: 95%

INTENDED USES:
INDOOR; LOW LIGHT;
HAZY // CLOUDY



LENS: **YELLOW**
VLT: 91%

INTENDED USES:
INDOOR; LOW LIGHT;
HAZY // CLOUDY



LENS: **INDOOR/OUTDOOR
// I/O FOG-OFF™**
VLT: 50%

INTENDED USES:
INDOOR; NIGHTTIME; HAZY //
CLOUDY



LENS: **SMOKE //
SMOKE FOG-OFF™**
VLT: 16%

INTENDED USES:
OUTDOOR; BRIGHT LIGHT



LENS: **COPPER**
VLT: 13%

INTENDED USES:
OUTDOOR; BRIGHT LIGHT;
HIGH CONTRAST



LENS: **SILVER MIRROR**
VLT: 10%

INTENDED USES:
OUTDOOR; BRIGHT LIGHT; GLARE



LENS: **HIGH-CONTRAST
PRECISION RED MIRROR**
VLT: 21%

INTENDED USES:
OUTDOOR; BRIGHT LIGHT; GLARE;
HIGH CONTRAST



LENS: **BLUE MIRROR**
VLT: 17%

INTENDED USES:
OUTDOOR; BRIGHT LIGHT; GLARE



LENS: **POLARIZED SMOKE**
VLT: 12%

INTENDED USES:
OUTDOOR; BRIGHT LIGHT; GLARE;
WATER



LENS: **POLARIZED COPPER**
VLT: 14%

INTENDED USES:
OUTDOOR; BRIGHT LIGHT; GLARE;
HIGH CONTRAST; WATER



LENS: **POLARIZED G15**
VLT: 11%

INTENDED USES:
OUTDOOR; BRIGHT LIGHT; GLARE;
HIGH CONTRAST; WATER



NON-POLARIZED LENS



DARE THE GLARE Polarized lenses utilize a special filter coating to block out reflected light from below and glare from above, allowing only direct light to enter the field of vision, making them a great choice for applications around water, shiny equipment, or anywhere glare and reflection elimination are key to safety and comfort. Choose from polarized smoke, polarized copper, or polarized G15 (a unique and soothing green tinted lens first developed for the US Air Force). You can see clearly now the glare is gone.

TYPICAL LENS



GO ON, FOG-OFF™ For those applications with extreme temperatures (and drastic changes in temperature), maintain a clear field of vision by choosing clear or smoke lenses with Fog-Off™ anti-fog technology that will not wash or wear off. Meets ATSM 659 Resistance to Fogging test requirements.



SKULLERZ® LENS // FRAME AVAILABILITY

	Clear Clear Fog-Off™	Yellow	Indoor/Outdoor I/O Fog-Off™	Smoke Smoke Fog-Off™	Copper	Silver Mirror	Blue Mirror	HCP Red Mirror	Polarized Smoke	Polarized Copper	Polarized G15
Odin - Black	50000 50003 Fog-Off	50050	50080 50083 Fog-Off	50030 50033 Fog-Off	50020	50042	50092	50012	50031	50021	50071
Odin - Matte Black	50400	—	—	50430	—	50442	—	—	—	—	—
Odin - Matte Gray	50100 50103 Fog-Off	50150	50180	50130 50133 Fog-Off	—	—	—	—	50131	50121	—
Odin - White	—	—	—	50230	—	50242	—	—	50231	—	—
Odin - Kryptek® Typhon™ Camo	50500 50503 Fog-Off	50550	—	50530 50533 Fog-Off	50520	—	—	—	50531	50521	—
Odin - Kryptek® Highlander™ Camo	50300 50303 Fog-Off	50350	—	50330 50333 Fog-Off	50320	—	—	—	50331	50321	—
Thor - Black	51000 51003 Fog-Off	51050	51080 51083 Fog-Off	51030 51033 Fog-Off	51020	51042	51092	51012	51031	51021	51071
Thor - Matte Gray	51100 51103 Fog-Off	51150	51180	51130 51133 Fog-Off	—	—	—	—	51131	51121	—
Thor - Kryptek® Typhon™ Camo	51300 51303 Fog-Off	51350	—	51330 51333 Fog-Off	51320	—	—	—	51331	51321	—
Dagr - Black	52000 52003 Fog-Off	52050	52080 52083 Fog-Off	52030 52033 Fog-Off	52020	52042	52092	52012	52031	52021	52071
Dagr - Matte Gray	52100 52103 Fog-Off	52150	52180	52130 52133 Fog-Off	—	—	—	—	52131	52121	—
Dagr - Kryptek® Typhon™ Camo	52500 52503 Fog-Off	52550	—	52530 52533 Fog-Off	52520	—	—	—	52531	52521	—
Dagr - Kryptek® Yeti™ Camo	52600 52603 Fog-Off	52650	—	52630 52633 Fog-Off	52620	—	—	—	52631	52621	—
Dagr - Kryptek® Highlander™ Camo	52300 52303 Fog-Off	52350	—	52330 52333 Fog-Off	52320	—	—	—	52331	52321	—
Kvasir - Black	53000	53050	53080	53030	—	53042	—	—	—	—	—
Kvasir - Matte Gray	53100	53150	53180	53130	—	—	—	—	—	—	—
Valkyrie - Black	54000 54003 Fog-Off	54050	54080 54083 Fog-Off	54030 54033 Fog-Off	54020	54042	54092	54012	54031	54021	54071
Valkyrie - Matte Gray	54100 54103 Fog-Off	54150	54180	54130 54133 Fog-Off	—	—	—	—	54131	54121	—
Njord - Black	55000	55050	55080	55030	—	55042	—	—	—	—	—
Njord - Matte Gray	55100	55150	55180	55130	—	—	—	—	—	—	—
Loki - Black	56000 56003 Fog-Off	56050	56080 56083 Fog-Off	56030 56033 Fog-Off	56020	56042	56092	56012	56031	56021	—
Loki - Matte Gray	56100 56103 Fog-Off	56150	56180	56130 56133 Fog-Off	—	—	—	—	56131	56121	—
Baldr - Black	57000 57003 Fog-Off	57050	57080 57083 Fog-Off	57030 57033 Fog-Off	57020	57042	—	—	57031	57021	—
Baldr - Matte Gray	57100 57103 Fog-Off	57150	57180	57130 57133 Fog-Off	57120	—	—	—	57131	57121	—
Baldr - Kryptek® Highlander™ Camo	57300 57303 Fog-Off	57350	—	57330 57333 Fog-Off	57320	—	—	—	57331	57321	—
Baldr - Kryptek® Typhon™ Camo	57500 57503 Fog-Off	57550	—	57530 57533 Fog-Off	—	—	—	—	57531	57521	—
Erda - Black	58000 58003 Fog-Off	58050	58080 58083 Fog-Off	58030 58033 Fog-Off	58020	58042	—	—	58031	58021	—
Erda - White	58200 58203 Fog-Off	58250	—	58230 58233 Fog-Off	—	—	—	—	58231	58221	—
Erda - Kryptek® Typhon™ Camo	58500 58503 Fog-Off	58550	—	58530 58533 Fog-Off	58520	—	—	—	58531	58521	—
Erda - Kryptek® Yeti™ Camo	58600 58603 Fog-Off	58650	—	58630 58633 Fog-Off	58620	—	—	—	58631	58621	—
Tyr - Matte Black	59000 59003 Fog-Off	—	59080 59083 Fog-Off	59030 59033 Fog-Off	—	—	—	—	—	—	—

SKULLERZ®
EYE & HEAD
PROTECTION

SKULLERZ® EYE PROTECTION:

EYE PROTECTION SERIES

DIFFERENTIATED BY DESIGN

ANSI // CSA // MIL-PRF BALLISTIC IMPACT PROTECTION

All Skullerz® models in all lenses meet both ANSI Z87.1+ High Velocity and MIL-PRF 32342 Ballistic Impact protection requirements. Select models also meet CSA 94.3.

KRYPTEK® CAMO

Stand out by blending in with Kryptek® - the baddest camo patterns out there.



ODIN

99.9% UV PROTECTION

All Skullerz® lenses, even clear, provide protection from 99.9% of harmful UVA // UVB // UVC rays.



DAGR

LENS OPTIONS

Choose from up to 14 different lens options including glare-busting polarized and inherent Fog-Off™ anti-fog technology that won't wash or wear off.

PATENTED BLADE STYLE DESIGN

Sleek blade style frame ensures excellent air flow and is designed to move easily from workplace to weekend.





<p>FULL FRAME SAFETY GLASSES</p>		<p>ODIN</p>	<p>ORDER MULTIPLE 1</p>
<ul style="list-style-type: none"> • Meets ANSI Z87.1+, CSA Z94.3 and MIL-PRF 32432 Impact Requirements • Scratch-resistant lenses block 99.9% of harmful UV rays • Full-frame design with coinjection rubber temples • Non-slip rubber nose piece • Available Fog-Off™ technology won't wash, wear off • Premium polarized lenses available • Optional foam gasket insert to reduce debris entry <div style="display: flex; justify-content: space-between; align-items: flex-start;"> <div data-bbox="291 1774 465 1885"> <p>FRAME COLORS</p> </div> <div data-bbox="524 1774 737 1873"> <p>LENS OPTIONS</p> </div> <div data-bbox="916 1619 1482 1833"> </div> </div>			





// PATENTED





<p>LARGE FRAME SAFETY GLASSES</p>		<p>THOR</p>	<p>ORDER MULTIPLE 1</p>
<ul style="list-style-type: none"> • Meets ANSI Z87.1+, CSA Z94.3 and MIL-PRF 32432 Impact Requirements • Scratch-resistant lenses block 99.9% of harmful UV rays • Full-frame design with coinjection rubber temples • Available Fog-Off™ technology won't wash, wear off • Premium polarized lenses available <div style="display: flex; justify-content: space-between; align-items: flex-start;"> <div data-bbox="309 625 477 688"> <p>FRAME COLORS</p> </div> <div data-bbox="539 625 751 716"> <p>LENS OPTIONS</p> </div> <div data-bbox="916 474 1503 701"> </div> </div> <p>// PATENTED</p>			

<p>HALF FRAME SAFETY GLASSES</p>		<p>DAGR</p>	<p>ORDER MULTIPLE 1</p>
<ul style="list-style-type: none"> • Meets ANSI Z87.1+, CSA Z94.3 and MIL-PRF 32432 Impact Requirements • Scratch-resistant lenses block 99.9% of harmful UV rays • Sleek blade frame with coinjection rubber temples • Non-slip rubber nose piece • Available Fog-Off™ technology won't wash, wear off • Premium polarized lenses available <div style="display: flex; justify-content: space-between; align-items: flex-start;"> <div data-bbox="309 1201 477 1306"> <p>FRAME COLORS</p> </div> <div data-bbox="539 1201 751 1291"> <p>LENS OPTIONS</p> </div> <div data-bbox="930 1041 1503 1268"> </div> </div> <p>// PATENTED</p>			

<p>LARGE FRAME SAFETY GLASSES</p>		<p>BALDR</p>	<p>ORDER MULTIPLE 1</p>
<ul style="list-style-type: none"> • Meets ANSI Z87.1+, CSA Z94.3 and MIL-PRF 32432 Impact Requirements • Scratch-resistant lenses block 99.9% of harmful UV rays • Large frame design for maximum coverage in style • Coinjection rubber temples • Available Fog-Off™ technology won't wash, wear off • Premium polarized lenses available • Optional foam gasket insert to reduce debris entry <div style="display: flex; justify-content: space-between; align-items: flex-start;"> <div data-bbox="309 1776 477 1881"> <p>FRAME COLORS</p> </div> <div data-bbox="539 1776 751 1866"> <p>LENS OPTIONS</p> </div> <div data-bbox="944 1612 1503 1839"> </div> </div> <p>// PATENT PENDING</p>			

<p>MEDIUM FRAME SAFETY GLASSES</p>		<p>KVASIR</p>	<p>ORDER MULTIPLE 1</p>
<ul style="list-style-type: none"> • Meets ANSI Z87.1+ and MIL-PRF 32432 Impact Requirements • Scratch-resistant lenses block 99.9% of harmful UV rays • Versatile medium frame design with rubber temples • Temple accessory slot also improves air flow • Optional foam gasket insert to reduce debris entry <p>FRAME COLORS</p>  <p>LENS OPTIONS</p> 			
<p>// PATENTED</p>			

<p>MEDIUM FRAME SAFETY GLASSES</p>		<p>VALKYRIE</p>	<p>ORDER MULTIPLE 1</p>
<ul style="list-style-type: none"> • Meets ANSI Z87.1+ and MIL-PRF 32432 Impact Requirements • Scratch-resistant lenses block 99.9% of harmful UV rays • Smooth medium frame design with rubber temples • Available Fog-Off™ technology won't wash, wear off • Premium polarized lenses available • Optional foam gasket insert to reduce debris entry <p>FRAME COLORS</p>  <p>LENS OPTIONS</p> 			
<p>// PATENTED</p>			

<p>LARGE FRAME SAFETY GLASSES</p>		<p>ERDA</p>	<p>ORDER MULTIPLE 1</p>
<ul style="list-style-type: none"> • Meets ANSI Z87.1+, CSA Z94.3 and MIL-PRF 32432 Impact Requirements • Scratch-resistant lenses block 99.9% of harmful UV rays • Designed specifically for female workers and wearers • Sleek temples; no rubber to snag in longer hair • Available Fog-Off™ technology won't wash, wear off • Premium polarized lenses available • Optional foam gasket insert to reduce debris entry <p>FRAME COLORS</p>  <p>LENS OPTIONS</p> 			
<p>// PATENT PENDING</p>			

<p>MEDIUM FRAME SAFETY GLASSES</p>		<p>NJORD</p>	<p>ORDER MULTIPLE 1</p>
<ul style="list-style-type: none"> • Meets ANSI Z87.1+ and MIL-PRF 32432 Impact Requirements • Scratch-resistant lenses block 99.9% of harmful UV rays • Stylish medium frame design • Great glasses at a super price point <div style="display: flex; justify-content: space-between; align-items: flex-start;"> <div data-bbox="303 619 651 724"> <p>FRAME COLORS</p> <p>LENS OPTIONS</p> </div> <div data-bbox="954 472 1492 682"> </div> </div> <p>// PATENTED</p>			

<p>FULL FRAME SAFETY GLASSES / GOGGLES</p>		<p>LOKI</p>	<p>ORDER MULTIPLE 1</p>
<ul style="list-style-type: none"> • Meets ANSI Z87.1+ and MIL-PRF 32432 Impact Requirements • Scratch-resistant lenses block 99.9% of harmful UV rays • Removable rubber temples converts Loki to goggle • Available Fog-Off™ technology won't wash, wear off • Premium polarized lenses available • Removable foam gasket insert and strap included <div style="display: flex; justify-content: space-between; align-items: flex-start;"> <div data-bbox="303 1197 755 1302"> <p>FRAME COLORS</p> <p>LENS OPTIONS</p> </div> <div data-bbox="841 955 1536 1291"> </div> </div> <p>// PATENTED</p>			

<p>SINGLE LENS SAFETY GLASSES</p>		<p>TYR</p>	<p>ORDER MULTIPLE 1</p>
<ul style="list-style-type: none"> • Meets ANSI Z87.1+, CSA Z94.3 and MIL-PRF 32432 Impact Requirements • Scratch-resistant lens blocks 99.9% of harmful UV rays • Single lens, blade frame design provides wide field of vision and coverage • Rubber temple tips and nose piece • Available Fog-Off™ technology won't wash, wear off <div style="display: flex; justify-content: space-between; align-items: flex-start;"> <div data-bbox="303 1774 685 1879"> <p>FRAME COLORS</p> <p>LENS OPTIONS</p> </div> <div data-bbox="954 1606 1501 1837"> </div> <div data-bbox="1414 1711 1501 1816"> </div> </div> <p>// PATENT PENDING</p>			

SKULLERZ® EYE PROTECTION:

ACCESSORY SERIES

DIFFERENTIATED BY DESIGN

BALLISTIC NYLON

A rugged ballistic nylon outer shell provides protection and a tough, durable lair for your pair.

ZIPPER CLOSURE

Zipper closure for easy open and close.

MICROFIBER CLEANING CLOTH

All Skullerz® Cases include a 3216 microfiber cleaning cloth for scratch-free lens cleaning.



3225		<small>ORDER MULTIPLE</small> 1
BALLISTIC ZIPPER CASE		
		
<ul style="list-style-type: none"> • Ballistic nylon shell with soft brushed inside • Fits and stores all Skullerz® models • Zipper closure • Includes 3216 microfiber cleaning cloth 		
<small>ITEM #</small>	<small>SIZE</small>	<small>COLOR</small>
19225	—	Black



3222		<small>ORDER MULTIPLE</small> 1
ZIPPER CASE WITH CLIP		
		
<ul style="list-style-type: none"> • Nylon shell with soft brushed inside • Fits and stores all Skullerz® models • Convenient clip attaches to other gear • Zipper closure • Includes 3216 microfiber cleaning cloth 		
<small>ITEM #</small>	<small>SIZE</small>	<small>COLOR</small>
19222	—	Black

3216		<small>ORDER MULTIPLE</small> 12
MICROFIBER CLEANING CLOTH		
		
<ul style="list-style-type: none"> • Safely cleans lenses without scratching • Soft microfiber material • Embossed Ergodyne logo pattern 		
<small>ITEM #</small>	<small>SIZE</small>	<small>COLOR</small>
19216	—	Black

3218		<small>ORDER MULTIPLE</small> 12
MICROFIBER CLEANING BAG		
		
<ul style="list-style-type: none"> • Safely cleans lenses without scratching • Soft microfiber material • Embossed Ergodyne logo pattern 		
<small>ITEM #</small>	<small>SIZE</small>	<small>COLOR</small>
19218	—	Black

	3200	ORDER MULTIPLE 24
COTTON EYEWEAR LANYARD		
		
<ul style="list-style-type: none"> • 100% cotton • Adjustable barrel slide • Slides over temple ends 		
ITEM #	SIZE	COLOR
19152	—	Black

	3215	ORDER MULTIPLE 24
BREAKAWAY COTTON EYEWEAR LANYARD		
		
<ul style="list-style-type: none"> • 100% cotton • Breakaway design • Adjustable barrel slide • Slides over temple ends 		
ITEM #	SIZE	COLOR
19212	—	Black

	3251	ORDER MULTIPLE 24
BREAKAWAY ROPE EYEWEAR LANYARD		
		
<ul style="list-style-type: none"> • 3mm braided nylon rope • Breakaway design • Slip-style attachment fits variety of temple sizes 		
ITEM #	SIZE	COLOR
19342	—	Black

	3275	ORDER MULTIPLE 24
NEOPRENE EYEWEAR LANYARD		
		
<ul style="list-style-type: none"> • Lightweight neoprene • Slides over temple ends 		
ITEM #	SIZE	COLOR
19402	—	Black

	3280	ORDER MULTIPLE 24
ELASTIC COIL EYEWEAR LANYARD		
		
<ul style="list-style-type: none"> • Stretchable nylon/elastic • Slip-style attachment fits variety of temple sizes 		
ITEM #	SIZE	COLOR
19280	—	Black

	STRAPS	ORDER MULTIPLE 12																																								
STRAPS & GASKETS																																										
																																										
<ul style="list-style-type: none"> • Reduces dust and debris entry • Snaps in place at corners • Easily removes when not desired or for cleaning • Use alone or with elastic retainer strap 																																										
<table style="width: 100%; border: none;"> <tr> <td style="width: 50%;">STRAP</td> <td style="width: 50%;">GASKETS</td> </tr> <tr> <td style="font-size: 0.8em;">ITEM #</td> <td style="font-size: 0.8em;">ITEM #</td> </tr> <tr> <td style="font-size: 0.8em;">59991</td> <td style="font-size: 0.8em;">50991</td> </tr> <tr> <td style="font-size: 0.8em;">—</td> <td style="font-size: 0.8em;">—</td> </tr> <tr> <td style="font-size: 0.8em;">Odin</td> <td style="font-size: 0.8em;">Odin</td> </tr> <tr> <td style="font-size: 0.8em;">59991</td> <td style="font-size: 0.8em;">53991</td> </tr> <tr> <td style="font-size: 0.8em;">—</td> <td style="font-size: 0.8em;">—</td> </tr> <tr> <td style="font-size: 0.8em;">Kvasir</td> <td style="font-size: 0.8em;">Kvasir</td> </tr> <tr> <td style="font-size: 0.8em;">59991</td> <td style="font-size: 0.8em;">54991</td> </tr> <tr> <td style="font-size: 0.8em;">—</td> <td style="font-size: 0.8em;">—</td> </tr> <tr> <td style="font-size: 0.8em;">Valkyrie</td> <td style="font-size: 0.8em;">Valkyrie</td> </tr> <tr> <td style="font-size: 0.8em;">59991</td> <td style="font-size: 0.8em;">Included</td> </tr> <tr> <td style="font-size: 0.8em;">—</td> <td style="font-size: 0.8em;">—</td> </tr> <tr> <td style="font-size: 0.8em;">Dagr</td> <td style="font-size: 0.8em;">Loki</td> </tr> <tr> <td style="font-size: 0.8em;">57991</td> <td style="font-size: 0.8em;">—</td> </tr> <tr> <td style="font-size: 0.8em;">—</td> <td style="font-size: 0.8em;">—</td> </tr> <tr> <td style="font-size: 0.8em;">Baldr</td> <td style="font-size: 0.8em;">Baldr</td> </tr> <tr> <td style="font-size: 0.8em;">58991</td> <td style="font-size: 0.8em;">—</td> </tr> <tr> <td style="font-size: 0.8em;">—</td> <td style="font-size: 0.8em;">—</td> </tr> <tr> <td style="font-size: 0.8em;">Erda</td> <td style="font-size: 0.8em;">Erda</td> </tr> </table>			STRAP	GASKETS	ITEM #	ITEM #	59991	50991	—	—	Odin	Odin	59991	53991	—	—	Kvasir	Kvasir	59991	54991	—	—	Valkyrie	Valkyrie	59991	Included	—	—	Dagr	Loki	57991	—	—	—	Baldr	Baldr	58991	—	—	—	Erda	Erda
STRAP	GASKETS																																									
ITEM #	ITEM #																																									
59991	50991																																									
—	—																																									
Odin	Odin																																									
59991	53991																																									
—	—																																									
Kvasir	Kvasir																																									
59991	54991																																									
—	—																																									
Valkyrie	Valkyrie																																									
59991	Included																																									
—	—																																									
Dagr	Loki																																									
57991	—																																									
—	—																																									
Baldr	Baldr																																									
58991	—																																									
—	—																																									
Erda	Erda																																									
ITEM #	SIZE	COLOR																																								
19402	—	Black																																								



SKULLERZ® HEAD PROTECTION

Larry, Curly, and Moe made their living getting beamed in the noggin'. You don't have that luxury. That's where Skullerz® Head Protection steps in to take the hit. You may get fewer laughs but trust us, it'll be worth it. All models feature thermo-formed foam padding inside a removable, patented shell, and a smooth lid with mesh venting for that comfy covert fit. Available in micro brim, short brim, and baseball brim-styling, there's even a built-in LED option. Put it on, you lunkhead.

HEAD PROTECTION // BUMP CAP SERIES



8950 Micro Brim



8950/8950XL Short Brim



8950/8950XL Long Brim



8955 Ranger Bump Cap



8960 LED Short Brim



8960 LED Long Brim

**BANG A GONG.
NOT YOUR HEAD.**

SKULLERZ
EYE & HEAD
PROTECTION

SKULLERZ®

HEAD PROTECTION

SKULLERZ®:

BUMP CAP SERIES

DIFFERENTIATED BY DESIGN



PATENTED SHELL

Flanged shell flexes for fit and comfort while ribs provide stability and support; innovative ventilation system allows the shell to breathe.

COOL LID

Choose from 80mm, 50mm or 30mm (30mm in 8950 only) brim lengths in a variety of color options, all with mesh venting panels and reflective accents.

EN 812 COMPLIANT

All Skullerz® Bump Caps are tested and certified to the rigorous criteria of EN 812, the world's only bump cap standard.



8960

LED LIGHTING TECHNOLOGY

Enhance worker productivity and ditch the bulky headlamp for 4 super-bright in-brim LEDs.

INNOVATIVE CLOSURE

Elastic hook and loop closure stretches and is angled to provide a snug, secure fit.



FIND OUT MORE ABOUT THE TECHNOLOGY THAT GOES INTO THE FULL LINE OF ERGODYNE EYE & HEAD PROTECTION AT: WWW.ERGODYNE.COM

BUMP CAP / XL BUMP CAP				8950	ORDER MULTIPLE 1																																																
<ul style="list-style-type: none"> Removable impact-resistant shell with foam lining Patented flanged design for comfort and air flow Nylon or hi-vis polyester with reflective accents Micro (30mm), short (50mm) or long (80mm) brim EN 812-compliant patented design 				XL SHELL NOW AVAILABLE! 																																																	
8950: BLACK <table border="1"> <thead> <tr><th>ITEM #</th><th>SIZE</th><th>COLOR</th></tr> </thead> <tbody> <tr><td>23342</td><td>Micro</td><td>Black</td></tr> <tr><td>23340</td><td>Short</td><td>Black</td></tr> <tr><td>23346</td><td>Short (XL)</td><td>Black</td></tr> <tr><td>23344</td><td>Long</td><td>Black</td></tr> <tr><td>23348</td><td>Long (XL)</td><td>Black</td></tr> </tbody> </table>		ITEM #	SIZE	COLOR	23342	Micro	Black	23340	Short	Black	23346	Short (XL)	Black	23344	Long	Black	23348	Long (XL)	Black	8950: NAVY <table border="1"> <thead> <tr><th>ITEM #</th><th>SIZE</th><th>COLOR</th></tr> </thead> <tbody> <tr><td>23341</td><td>Micro</td><td>Navy</td></tr> <tr><td>23343</td><td>Short</td><td>Navy</td></tr> <tr><td>23347</td><td>Short (XL)</td><td>Navy</td></tr> <tr><td>23345</td><td>Long</td><td>Navy</td></tr> <tr><td>23349</td><td>Long (XL)</td><td>Navy</td></tr> </tbody> </table>		ITEM #	SIZE	COLOR	23341	Micro	Navy	23343	Short	Navy	23347	Short (XL)	Navy	23345	Long	Navy	23349	Long (XL)	Navy	8950: LIME <table border="1"> <thead> <tr><th>ITEM #</th><th>SIZE</th><th>COLOR</th></tr> </thead> <tbody> <tr><td>23331</td><td>Micro</td><td>Lime</td></tr> <tr><td>23333</td><td>Short</td><td>Lime</td></tr> <tr><td>23335</td><td>Long</td><td>Lime</td></tr> </tbody> </table>		ITEM #	SIZE	COLOR	23331	Micro	Lime	23333	Short	Lime	23335	Long	Lime
ITEM #	SIZE	COLOR																																																			
23342	Micro	Black																																																			
23340	Short	Black																																																			
23346	Short (XL)	Black																																																			
23344	Long	Black																																																			
23348	Long (XL)	Black																																																			
ITEM #	SIZE	COLOR																																																			
23341	Micro	Navy																																																			
23343	Short	Navy																																																			
23347	Short (XL)	Navy																																																			
23345	Long	Navy																																																			
23349	Long (XL)	Navy																																																			
ITEM #	SIZE	COLOR																																																			
23331	Micro	Lime																																																			
23333	Short	Lime																																																			
23335	Long	Lime																																																			
// PATENTED																																																					

SKULLERZ EYE & HEAD PROTECTION

BUMP CAP + LED LIGHTING TECHNOLOGY				8960	ORDER MULTIPLE 1																											
<ul style="list-style-type: none"> Patented LED lighting technology built in under brim Removable impact-resistant shell with foam lining Patented flanged design for comfort and air flow Nylon or hi-vis polyester with reflective accents EN 812-compliant patented design 																																
8960: BLACK <table border="1"> <thead> <tr><th>ITEM #</th><th>SIZE</th><th>COLOR</th></tr> </thead> <tbody> <tr><td>23370</td><td>Short</td><td>Black</td></tr> <tr><td>23374</td><td>Long</td><td>Black</td></tr> </tbody> </table>		ITEM #	SIZE	COLOR	23370	Short	Black	23374	Long	Black	8960: NAVY <table border="1"> <thead> <tr><th>ITEM #</th><th>SIZE</th><th>COLOR</th></tr> </thead> <tbody> <tr><td>23373</td><td>Short</td><td>Navy</td></tr> <tr><td>23375</td><td>Long</td><td>Navy</td></tr> </tbody> </table>		ITEM #	SIZE	COLOR	23373	Short	Navy	23375	Long	Navy	8960: LIME <table border="1"> <thead> <tr><th>ITEM #</th><th>SIZE</th><th>COLOR</th></tr> </thead> <tbody> <tr><td>23377</td><td>Short</td><td>Lime</td></tr> <tr><td>23379</td><td>Long</td><td>Lime</td></tr> </tbody> </table>		ITEM #	SIZE	COLOR	23377	Short	Lime	23379	Long	Lime
ITEM #	SIZE	COLOR																														
23370	Short	Black																														
23374	Long	Black																														
ITEM #	SIZE	COLOR																														
23373	Short	Navy																														
23375	Long	Navy																														
ITEM #	SIZE	COLOR																														
23377	Short	Lime																														
23379	Long	Lime																														
// PATENTED																																

RANGER BUMP CAP				8955	ORDER MULTIPLE 1												
<ul style="list-style-type: none"> Removable impact-resistant shell with foam lining Patented flanged design for comfort and air flow Nylon or hi-vis polyester with reflective accents Wide brim for shade; breathable vented side panels EN 812-compliant patented design 																	
8955: HV LIME <table border="1"> <thead> <tr><th>ITEM #</th><th>SIZE</th><th>COLOR</th></tr> </thead> <tbody> <tr><td>22356</td><td>—</td><td>HV Lime</td></tr> </tbody> </table>		ITEM #	SIZE	COLOR	22356	—	HV Lime	8955: KHAKI <table border="1"> <thead> <tr><th>ITEM #</th><th>SIZE</th><th>COLOR</th></tr> </thead> <tbody> <tr><td>22357</td><td>—</td><td>Khaki</td></tr> </tbody> </table>		ITEM #	SIZE	COLOR	22357	—	Khaki		
ITEM #	SIZE	COLOR															
22356	—	HV Lime															
ITEM #	SIZE	COLOR															
22357	—	Khaki															
// PATENTED																	



PRODUC

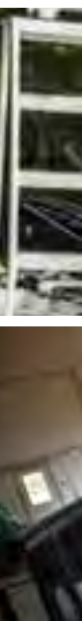

TIVITY



squids[®]

- » LANYARDS
- » ORGANIZERS

ARSENAL[®]

- » GEAR STORAGE
- » TOOL STORAGE



FOUR SIMPLE STEPS TO SAFER WORK.
OBJECTS AT HEIGHTS

PLAN YOUR WORK.

TRAPPING

Trapping refers to retrofitting a connection point onto a tool for a safer attachment point. Most tools do not come with a secure attachment point built into the tool. In these situations, a secure attachment point must be created.

ONE STEP TOOL TRAPS



TWO STEP TOOL TRAPS



TETHERING

Once all tools have a connection point the appropriate tethering solution can be selected. Consider the following factors to select the appropriate solution: weight of tool, type of connector(s) on lanyard, clearance, reach, and snag hazard.



WRIST LANYARDS



RETRACTABLE LANYARDS



COILED LANYARDS



SHOCK ABSORBING ELASTIC LANYARDS



SPECIALTY LANYARDS

WORK YOUR PLAN.

TOPPING

There are different ways of transporting equipment to heights and a variety of containers used to store the equipment while in transit. Regardless of what container is used, there are three critical best practices: hands-free climbing, closed container, and weight rating.

CARRYING



AT HEIGHTS TOOL RIG:

- 5517
- 5527

HOISTING

BUCKET:

- 5960T



BAG:

- 5843



TRAINING

Check out our comprehensive Objects at Heights (O@H) training programs and collateral covering everything from basic training to certified Drop Cop®. Visit www.ergodyne.com for more or email orders@ergodyne.com to get your schooling started.

LEARN HOW TO BECOME A DROP COPS® PRO...



LEARN TO TRAP, TETHER, AND TOP IN OUR 52-PAGE BIBLE OF OBJECTS AT HEIGHTS SAFETY SOLUTIONS KNOWN AS THE DROP COPS® GUIDE.



BECOME COMPETENT WITH O@H TRAINING AVAILABLE THROUGH ERGODYNE.



STAY SAFE ON THE JOB WITH O@H GUIDES AND TETHERING SYSTEM POSTERS.

ergodyne WORK GEAR

GRIPS FREE ZONE™ TOOL TETHERING SYSTEM

TOOL TYPES: [Icons of various tools]

TRAPPING	TETHERING	TOPPING
Trapping refers to restricting a movement point such as a tool. Most tools do not come with a secure attachment point. Attaching tools into the tool's attachment point must be correct.	Clear all tools have a connection point. Use appropriate tethering solutions and be attached.	Workers use transport equipment to heights to carry or hoist. There are a variety of weight rated containers available to safely transport.
[Tool icons]	[Tool icons]	[Tool icons]

COMMON TOOLS:

[Tool icon]	[Tool icon]	[Tool icon]	[Tool icon]
[Tool icon]	[Tool icon]	[Tool icon]	[Tool icon]
[Tool icon]	[Tool icon]	[Tool icon]	[Tool icon]
[Tool icon]	[Tool icon]	[Tool icon]	[Tool icon]

squids™ LADDERS & ORGANIZERS



SQUIDS[®]
LANYARDS & WORKSITE ORGANIZERS



**LOVE STINKS
BUT GRAVITY HURTS.**



SQUIDS® LANYARDS & ORGANIZERS

An apple dropping from a tree during a mathematician's summer idyll in the English countryside is one thing. Sledgehammers plummeting 40 stories onto a busy worksite is a recipe for an ambulance. Spare yourself that sinking feeling with our smorgasbord of lanyards and organizers. Squids® Lanyard and Organizers trap, retract, extend, and secure your gear, so it's always in the last place you left it.

LANYARDS // ATTACHMENT SERIES



3700 Tool Tails™ - Web Extension



3703/3713 Tool Tails™ - Elastic Loop



3103 Detachable Loops



3750 Heat Tape Trap

LANYARDS // TOOL LANYARD SERIES



3100F(x)/3110F(x) Single & Dual Carabiner



3107F(x)/3117F(x) Single & Dual Composite Locking Carabiner



3102F(x) Single Carabiner Modular



3103F(x) Modular Tool Tails Modular

LANYARDS // TOOL LANYARD SERIES



3109/3119 Triple-Locking Single & Double Carabiner



3101/3111 Stainless Single & Dual Carabiner



3311 Stainless Twin Leg



3102 Detachable Single Carabiner

LANYARDS // ID LANYARDS & SPECIALTY SERIES



3386 Arm Band ID & Badge Holder



3386HV HV Arm Band ID & Badge Holder



3150/3155 Hard Hat Lanyard



3157/3158 Hard Hat Lanyard

WORKSITE ORGANIZERS // GRABBER SERIES



3400 Dual Clip Grabber



3405 Belt Clip Grabber



3400MD Metal Detectable Grabber



3405MD Metal Detectable Grabber



3755 Self-adhering Tape Trap



3723 Cold Shrink Trap



3790 Shackle Trap



3770 Tape Measure Trap



3780 Power Tool Trap



3108F(x) Single Locking Carabiner



3118F(x) Dual Locking Carabiner



3109F(x) Single Swiveling Locking Carabiner



3119F(x) Dual Swiveling Locking Carabiner



3100/3110 Single Carabiner & Dual Carabiner



3130 Coil Tool Lanyard



3114/3116 Wrist Tool Lanyard



3115 Wrist Tool Lanyard



3175 Accessory Anchor

**LANYARDS
// RETRACTOR SERIES**



3000 Retractable Tool Lanyard



3025 Extra Tails



3001 Retractable Tool Lanyard



3026 Extra Tails



3410 Grabber Anchor-Suction



3415 Grabber Anchor-Magnet

**WORKSITE ORGANIZERS
// ACCESSORY SERIES**



3540 Large Locking Hook



3800 Squids® Carabiners

SQUIDS®:

TOOL TETHERING KITS

RETROFIT CONNECTOR VARIETY

We study and teach tool anatomy to give you options for retrofit connection points on tools that need 'em. One-step Tool Traps™ with built in connection points attach directly to the tool. Two step systems use a Tool Tail™ to capture a Tool Tail™ connection to the tool.

DIFFERENTIATED BY DESIGN

THIRD-PARTY CERTIFIED WEIGHT RATINGS

Third-party certified with a safety factor of 2:1 to ensure the utmost in security. Connector systems applied with more than one component are tested and certified together as a system. We don't have to but we do!

FUNCTIONAL MATERIALS AND DESIGNS

Squids® Tool Connectors are designed to NOT sacrifice your tool's primary use. Tool Traps™ and Tool Tails™ can be placed on the tool leaving mission critical parts of the tool ready to use. Specialty materials enhance grip and do not leave messy adhesives or residue on your tools.



TETHERING SOLUTIONS: PUTTING THE KIT TOGETHER.

If more than three decades in the industry has taught us anything, it's that convenience is king when it comes to safety measures. With that in mind, we've put together six popular "ready-to-go" tethering kits for common job site tools. They're designed to be easy to choose and easy to use, so you have no excuse to be too legit to kit. You don't have to be Pythagoras to do the math either: Tool + Tail/Trap + Tether = a tailor-made solution to help you slow gravity's roll.

3180 KIT

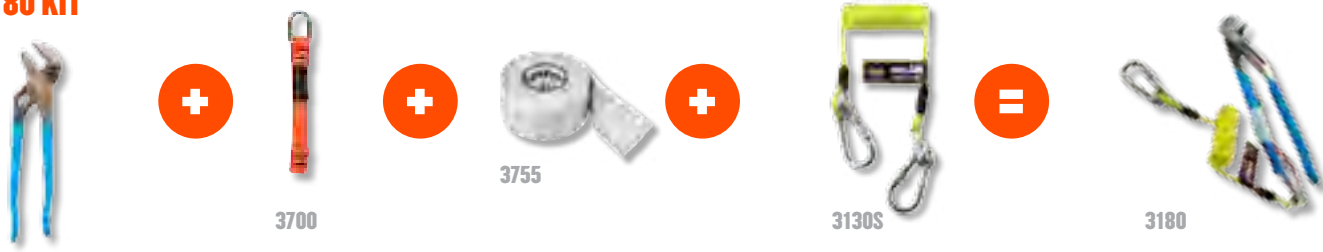

3191 KIT



		3180	ORDER MULTIPLE 1
2LB (0.9KG) TOOL TETHERING KIT			
<ul style="list-style-type: none"> • Tether up to six 2lb (0.9kg) tools • Kit includes 3700, 3755, and 3130S • 3700: 4.5" (11.5cm) Web Tool Tails (6 Pack) • 3755: Self-Adhering Tape Trap requires no heat • 3130S: Coiled lanyard design prevents snagging 			
ITEM #	SIZE	COLOR	
19650	Kit		

		3181	ORDER MULTIPLE 1
5LB (2.3KG) TOOL TETHERING KIT			
<ul style="list-style-type: none"> • Tether up to four 5lb (2.3kg) tools • Kit includes 3103, 3755, and 3102 • 3103: Accessory Kit - Detachable Loops (3 Pack) • 3755: Self-Adhering Tape Trap requires no heat • 3102: Detachable Single Carabiner 			
ITEM #	SIZE	COLOR	
19651	Kit		

		3182	ORDER MULTIPLE 1
10LB (4.5KG) TOOL TETHERING KIT			
<ul style="list-style-type: none"> • Tether up to three 10lb (4.5kg) tools • Kit includes 3713, 3755, and 3100F(x) • 3713: Elastic Loop Tool Tails™ Swivel • 3755: Self-Adhering Tape Trap requires no heat • 3100F(x): Tool Lanyard Single Carabiner 			
ITEM #	SIZE	COLOR	
19652	Kit		

		3192	ORDER MULTIPLE 1
3LB (1.4KG) WRIST LANYARD TETHERING KIT			
<ul style="list-style-type: none"> • Tether up to four 3lb (1.4kg) tools • Kit includes 3103, 3755, and 3116 • 3103: Accessory Kit - Detachable Loops (3 Pack) • 3755: Self-Adhering Tape Trap requires no heat • 3116: Pull-On Wrist Lanyard with Buckle 			
ITEM #	SIZE	COLOR	
19662	Kit		

		3190	ORDER MULTIPLE 1
TAPE MEASURE TETHERING KIT			
<ul style="list-style-type: none"> • Tether one standard tape measure • Kit includes 3770 and 3130S • 3770: Tape Measure Trap • 3130S: Coiled lanyard design prevents snagging 			
ITEM #	SIZE	COLOR	
19660	Kit		

		3191	ORDER MULTIPLE 1
POWER TOOL TETHERING KIT			
<ul style="list-style-type: none"> • Tether one standard cordless power tool • Kit includes 3780L and 3100F(x) • 3780L: Power Tool Trap (Large) • 3100F(x): Tool Lanyard Single Carabiner 			
ITEM #	SIZE	COLOR	
19661	Kit		

squids LANYARDS & ORGANIZERS

SQUIDS® LANYARDS:

ATTACHMENT SERIES

DIFFERENTIATED BY DESIGN

SECURE HARDWARE

Fully enclosed plated hardware has no weak point. Made of durable metals that last, they are not bent or welded giving you confidence in the security of your retrofit connection.

THIRD-PARTY CERTIFIED WEIGHT RATINGS

Third-party certified with a safety factor of 2:1 to ensure the utmost in security. Connector systems applied with more than one component are tested and certified together as a system. We don't have to but we do!

DURABLE SYNTHETIC MATERIALS

Squids® Tool Tails™ and Tool Traps™ are made with high tensile strength webbing and abrasion resistant fabric to hold up in the toughest applications and prolong the life of the connector.

RETROFIT CONNECTOR VARIETY

We study and teach tool anatomy to give you options for retrofit connection points on tools that need 'em. One-step Tool Traps™ with built in connection points attach directly to the tool. Two step systems use a Tool Trap™ to capture a Tool Tail™ connection to the tool.

FUNCTIONAL MATERIALS AND DESIGNS

Squids® Tool Connectors are designed to NOT sacrifice your tool's primary use. Tool Traps™ and Tool Tails™ can be placed on the tool leaving mission critical parts of the tool ready to use. Specialty materials enhance grip and do not leave messy adhesives or residue on your tools.



3700

ORDER MULTIPLE 6

WEB TOOL TAILS™



- Ultra strength nylon webbing
- Fully enclosed plated D-ring for secure attachment
- High tensile strength nylon thread
- Web catch with double stitch for more durable stop
- Used w/ Tape Traps; creates retrofit tether point

6 PACK ITEM #	60 PACK ITEM #	SIZE	COLOR
19703	19703-Bulk	3.5" (9.0cm)	Black
19704	19704-Bulk	4.5" (11.5cm)	Orange
19705	19705-Bulk	5.5" (14.0cm)	Black
19706	—	6.5" (16.5cm)	Orange
19708	—	8.5" (21.5cm)	Black
19701	—	Variety (5 sizes)	Black/Orange

3103/3703/3713

ORDER MULTIPLE 6

ELASTIC TOOL TAILS™



- Stretch cord surrounded by tubular-nylon webbing
- Fully enclosed plated O-ring for secure attachment
- Adjustable barrel lock for tool attachment
- Use as an anchor for belt, harness, or structure
- Used w/ Tool Trap™; creates retrofit tether point

3703: D-RING 15LB (6.8KG)

3 PACK ITEM #	60 PACK ITEM #	SIZE	COLOR
19767	19767-Bulk	11"(28cm)	HV Lime
19769	—	18"(46cm)	HV Lime

3713: W/ SWIVEL 10LB (4.5KG)

3 PACK ITEM #	60 PACK ITEM #	SIZE	COLOR
19765	19765-Bulk	11"(28cm)	HV Lime

3103: BUCKLE 5LB (2KG)

3 PACK ITEM #	60 PACK ITEM #	SIZE	COLOR
19068	—	12.5"(32cm)	Black
19069	—	12.5"(32cm)	HV Lime

// PATENT PENDING



3755

ORDER MULTIPLE
1

SELF-ADHERING TAPE TRAP

MAXIMUM LOAD LIMIT
10 POUNDS
[4.5 KG]

- Self-adhering requires no tools for application
- No adhesives for easy replacement
- Fiberglass reinforcement
- Cut and puncture resistant
- Added grip to handle of tools
- Used w/ Tool Tail™; creates retrofit tether point

ITEM #	SIZE	COLOR
19755	1" x 12' (2.5cm x 3.7m)	Gray

3750

ORDER MULTIPLE
1

HEAT TAPE TRAP

MAXIMUM LOAD LIMIT
15 POUNDS
[6.8 KG]

AVAILABLE IN TWO ROLL LENGTHS

- Non-silicone based TPE material
- No adhesives so it can be replaced without a mess
- Set with heat application for secure attachment
- Material content provides enhanced grip
- Used w/ Tool Tail™; creates retrofit tether point

ITEM #	SIZE	COLOR
19760	1" x 12' (2.5cm x 3.7m)	Orange
19761	1" x 30' (2.5cm x 9.1m)	Orange

3723/3724/3726

ORDER MULTIPLE
1

COLD SHRINK TRAP

AVAILABLE IN THREE SIZES

- Cold Shrink technology requires no heat source
- EPDM rubber resists acids and extreme temps
- No other tools needed to create secure connection
- Tool diameter range of 0.75" - 2.50" (1.9 - 6.4cm)
- Used w/ Tool Tail™; creates retrofit tether point

3723: 5LB (2KG) 3724: 10LB (4.5KG) 3726: 15LB (6.8KG)

ITEM #	SIZE	ITEM #	SIZE	ITEM #	SIZE
19723	3" (7.6cm)	19724	4" (10.2cm)	19726	6" (15.3cm)

// PATENT PENDING

3770

ORDER MULTIPLE
1

TAPE MEASURE TRAP

MAXIMUM LOAD LIMIT
2 POUNDS
[0.9 KG]

- Polyester main material
- Hook and loop straps secure tape measure
- Nickel-plated belt clip
- Zinc-plated cast D-Ring
- Fits most standard tape measures

ITEM #	SIZE	COLOR
19770	—	Orange

// PATENT PENDING

3780

ORDER MULTIPLE
1

POWER TOOL TRAP™

MAXIMUM LOAD LIMIT
6 POUNDS
[2.7 KG]

- 1000D nylon with water-resistant backing
- Hook and loop straps secure power tool battery
- Nickel-plated cast D-ring
- Prevents battery from becoming a dropped object
- Fits most power tool batteries

ITEM #	SIZE	COLOR
19782	S	Black
19784	L	Black

// PATENT PENDING

3790

ORDER MULTIPLE
1

SHACKLE TRAPS

MAXIMUM LOAD LIMIT
15 POUNDS
[6.8 KG]

PACKAGED 2 PER PACK

- Stainless steel (#304) material
- One step retrofit attachment for tethering point
- Connects around midsection of a waisted tool
- Secure by adding a drop of adhesive and tightening

ITEM #	SIZE	COLOR
19792	S	Stainless Steel
19793	M	Stainless Steel
19794	L	Stainless Steel
19795	XL	Stainless Steel

SQUIDS® LANYARDS:

TOOL & EQUIP. LANYARD SERIES

DIFFERENTIATED BY DESIGN



DURABLE LANYARD BODY

Whether high tensile strength webbing, reinforced stitching, or aircraft cable, Squids® Tool and Equipment Lanyards are made to hold up to the environment as well as a drop within it.

THIRD-PARTY CERTIFIED WEIGHT RATINGS

Third-party certified with a safety factor of 2:1 to ensure the utmost in security.

CAPTIVE EYE CARABINERS

Carabiners are designed with captive eyes to catch and hold webbing so it doesn't interfere with the connector's gate and will never be removed.

3100 F(x)

CARABINER VARIETY AND SECURITY

A variety of carabiner options give you what you need for your environment - lightweight aluminum, stainless steel, non-locking, and self-locking are some of the options available to give you jobsite flexibility.

SHOCK ABSORBING PROPERTIES

Stretch cord models exhibit shock absorbing properties limiting the force the body or other anchoring points feel when a drop occurs.

		<h1>3100</h1>	ORDER MULTIPLE 6
<h3>TOOL LANYARD SINGLE CARABINER</h3>			
<ul style="list-style-type: none"> • Durable 1680D shock absorbing poly webbing • Aluminum alloy carabiner with captive eye • Treaded loop end that grips the tool when attached • Low-profile lightweight design reduces snag hazards 			
ITEM #	SIZE	COLOR	
19802	Std. 38" - 70" (96cm - 178cm)	Gray	
// PATENT PENDING			

		<h1>3110</h1>	ORDER MULTIPLE 6
<h3>TOOL LANYARD DUAL CARABINER</h3>			
<ul style="list-style-type: none"> • Durable 1680D shock absorbing poly webbing • Aluminum alloy carabiners with captive eye • Carabiners designed for gloved hands • Low-profile lightweight design reduces snag hazards 			
ITEM #	SIZE	COLOR	
19822	Std. 38" - 70" (96cm - 178cm)	Gray	
// PATENT PENDING			

		<h1>3108</h1>	ORDER MULTIPLE 6
<h3>TOOL LANYARD SINGLE LOCKING CARABINER</h3>			
<ul style="list-style-type: none"> • Durable 1680D shock absorbing poly webbing • Double-action aluminum carabiner with captive eye • Treaded loop end that grips the tool when attached • Low-profile lightweight design reduces snag hazards 			
ITEM #	SIZE	COLOR	
19808	Std. 38" - 70" (96cm - 178cm)	Orange	
// PATENT PENDING			

		<h1>3118</h1>	ORDER MULTIPLE 6
<h3>TOOL LANYARD DUAL LOCKING CARABINER</h3>			
<ul style="list-style-type: none"> • Durable 1680D shock absorbing poly webbing • Double-action aluminum carabiners with captive eye • Carabiners designed for gloved hands • Low-profile lightweight design reduces snag hazards 			
ITEM #	SIZE	COLOR	
19828	Std. 38" - 70" (96cm - 178cm)	Orange	
// PATENT PENDING			

MAY THE FORCE NOT BE WITH YOU...

Ergodyne Squids® Tool Lanyards are scientifically engineered to reduce drop forces and prevent workers from being pulled down when they drop an object. When you choose an Ergodyne lanyard, you're choosing superior materials and performance developed and tested (hundreds of times) to be the best – hands down. As you can see below, the results speak for themselves. Don't believe us? Visit www.ergodyne.com and click the WATCH tab to see this drop test with your own eyes. No smoke and mirrors here.

3 POUNDS [1.4 KG]

19.8 DROP FORCE READING

18.7 DROP FORCE READING

squids® THE OTHER GUYS

OURS ARE BETTER. PERIOD.

squids® LANYARDS & ORGANIZERS

		<h1>3107</h1>	ORDER MULTIPLE 6
<p>TOOL LANYARD SINGLE COMPOSITE LOCKING CARABINER</p>			
			
			
<ul style="list-style-type: none"> • Durable 1680D shock absorbing poly webbing • Double-action composite carabiner with captive eye • Treaded loop end that grips the tool when attached • Low-profile lightweight design reduces snag hazards • Composite carabiners resistant to -140 F (-60 C) 			
ITEM #	SIZE	COLOR	
19807	Std. 38" - 70" (96cm - 178cm)	Gray	
// PATENT PENDING			



		<h1>3117</h1>	ORDER MULTIPLE 6
<p>TOOL LANYARD DUAL COMPOSITE LOCKING CARABINER</p>			
			
			
<ul style="list-style-type: none"> • Durable 1680D shock absorbing poly webbing • Double-action composite carabiner with captive eye • Carabiners designed for gloved hands • Low-profile lightweight design reduces snag hazards • Composite carabiners resistant to -140°F (-60°C) 			
ITEM #	SIZE	COLOR	
19827	Std. 38" - 70" (96cm - 178cm)	Gray	
// PATENT PENDING			



		<h1>3102</h1>	ORDER MULTIPLE 6
<p>TOOL LANYARD SINGLE CARABINER - MODULAR</p>			
			
			
<ul style="list-style-type: none"> • Durable 1680D shock absorbing poly webbing • Anodized aluminum alloy carabiner with captive eye • Treaded loop end that grips the tool when attached • Low-profile lightweight design reduces snag hazards • Modular buckle for quickly exchanging tools 			
ITEM #	SIZE	COLOR	
19864	Std. 38" - 70" (96cm - 178cm)	Gray	
// PATENT PENDING			

		<h1>3109</h1>	ORDER MULTIPLE 6
<p>TOOL LANYARD SINGLE SWIVELING LOCKING CARABINER</p>			
			
			
<ul style="list-style-type: none"> • Durable 1680D shock absorbing poly webbing • Double-action aluminum carabiner with captive eye • Treaded loop end that grips the tool when attached • Low-profile lightweight design reduces snag hazards • Swiveling carabiners eliminate binding and snags 			
ITEM #	SIZE	COLOR	
19809	Std. 38" - 70" (96cm - 178cm)	Orange	
// PATENT PENDING			

		<h1>3119</h1>	ORDER MULTIPLE 6
<p>TOOL LANYARD DUAL SWIVELING LOCKING CARABINER</p>			
			
			
<ul style="list-style-type: none"> • Durable 1680D shock absorbing poly webbing • Double-action aluminum carabiners with captive eye • Carabiners designed for gloved hands • Low-profile lightweight design reduces snag hazards • Swiveling carabiners eliminate binding and snags 			
ITEM #	SIZE	COLOR	
19829	Std. 38" - 70" (96cm - 178cm)	Orange	
// PATENT PENDING			

		<h1>3103</h1>	ORDER MULTIPLE 6
<p>MODULAR TOOL TAILS - 3 PACK</p>			
			
			
<ul style="list-style-type: none"> • Durable 1680D shock absorbing poly webbing • Compatible with 3102F(x) modular tool lanyard • Treaded loop end that grips the tool when attached • Modular buckle for quickly exchanging tools • Allow multiple tools to be tether-ready 			
ITEM #	SIZE	COLOR	
19868	12.5" (32cm)	Gray	
// PATENT PENDING			

3100/3110		ORDER MULTIPLE 6	
SINGLE & DUAL CARABINER TOOL LANYARDS			
			
<ul style="list-style-type: none"> • Energy-absorbing cord with tubular-nylon webbing • Single-action aluminum carabiner • Reflective accent for higher visibility • Lock stitching at both ends for extra security 			
ITEM #	ITEM #	SIZE	COLOR
19002	19022	Std. 35" - 42" (89 - 110cm)	Black
19012	19032	Ext. 42" - 54" (110 - 140cm)	Black
19003	19023	Std. 35" - 42" (89 - 110cm)	HV Lime
19013	19033	Ext. 42" - 54" (110 - 140cm)	HV Lime

3101/3111		ORDER MULTIPLE 6	
SS SCREWGATE CARABINER LANYARDS			
			
<ul style="list-style-type: none"> • Energy-absorbing cord with tubular-nylon webbing • Manual locking stainless steel (SS) carabiners (#304) • Reflective accent for higher visibility • Lock stitching at both ends for extra security 			
ITEM #	ITEM #	SIZE	COLOR
19007	19027	Std. 35" - 42" (89 - 110cm)	HV Lime
19017	19037	Ext. 42" - 54" (110 - 140cm)	HV Lime

3109/3119		ORDER MULTIPLE 1	
HEAVY-DUTY TRIPLE LOCKING CARABINERS			
			
<ul style="list-style-type: none"> • Energy-absorbing cord with tubular-nylon webbing • Triple-locking (8KN) carabiner with swivel • Reflective accent for higher visibility • Lock stitching at both ends for extra security 			
ITEM #	ITEM #	SIZE	COLOR
19009	19029	Std. 35" - 42" (89 - 110cm)	HV Lime
19019	19039	Ext. 42" - 54" (110 - 140cm)	HV Lime

	3102	ORDER MULTIPLE 6						
DETACHABLE SINGLE CARABINER TOOL LANYARD								
								
<p style="text-align: center; font-weight: bold; color: red;">EXTRA TAILS (3103) 3-PACK</p> <table style="width: 100%; border-collapse: collapse;"> <tr> <td style="font-size: 0.8em;">ITEM #</td> <td style="font-size: 0.8em;">COLOR</td> </tr> <tr> <td>19068</td> <td>Black</td> </tr> <tr> <td>19069</td> <td>HV Lime</td> </tr> </table>			ITEM #	COLOR	19068	Black	19069	HV Lime
ITEM #	COLOR							
19068	Black							
19069	HV Lime							
<ul style="list-style-type: none"> • Energy-absorbing cord with tubular-nylon webbing • Single-action aluminum carabiner • Adjustable barrel lock for tool attachment • Modular connecting buckle for exchanging tools • Lock stitching at both ends for extra security 								
ITEM #	SIZE	COLOR						
19064	Std. 35" - 42" (89cm - 110cm)	Black						
19074	Ext. 42" - 54" (110cm - 140cm)	Black						
19065	Std. 35" - 42" (89cm - 110cm)	HV Lime						
19075	Ext. 42" - 54" (110cm - 140cm)	HV Lime						

	3311	ORDER MULTIPLE 1
SS SCREWGATE TRIPLE CARABINER - TWIN LEG		
		
<ul style="list-style-type: none"> • Energy-absorbing cord with tubular-nylon webbing • Manual locking stainless steel (SS) carabiners (#304) • Twin leg for two tools or 100% tie-off of one tool • Reflective accent for higher visibility • Lock stitching at both ends for extra security 		
ITEM #	SIZE	COLOR
19083	Std. 35" - 42" (89cm - 110cm)	HV Lime

	3108	ORDER MULTIPLE 6
HEAVY-DUTY SELF LOCKING CARABINER LANYARD		
		
<ul style="list-style-type: none"> • Energy-absorbing cord with tubular-nylon webbing • Heavy-duty (500kgf) self-locking carabiner • Adjustable barrel lock for tool attachment • Reflective accent for higher visibility • Lock stitching at both ends for extra security 		
ITEM #	SIZE	COLOR
19008	Short 28" - 35" (71cm - 89cm)	HV Lime

squids LANYARDS & ORGANIZERS

		3114	ORDER MULTIPLE 6								
PULL-ON WRIST TOOL LANYARD - CARABINER											
<ul style="list-style-type: none"> • Elastic maintains snug fit • Pull-on design provides easy on/off • One size fits all • Stainless steel (#304) carabiner • Tuck-away pocket to keep connector when not in use 											
<table border="1"> <thead> <tr> <th>ITEM #</th> <th>SIZE</th> <th>STYLE</th> <th>COLOR</th> </tr> </thead> <tbody> <tr> <td>19056</td> <td>—</td> <td>Carabiner</td> <td>Black</td> </tr> </tbody> </table>				ITEM #	SIZE	STYLE	COLOR	19056	—	Carabiner	Black
ITEM #	SIZE	STYLE	COLOR								
19056	—	Carabiner	Black								
// PATENT PENDING											

		3116	ORDER MULTIPLE 6								
PULL-ON WRIST TOOL LANYARD - BUCKLE											
<ul style="list-style-type: none"> • Elastic maintains snug fit • Pull-on design provides easy on/off • One size fits all • Modular quick connecting buckle • Tuck-away pocket to keep connector when not in use 											
<table border="1"> <thead> <tr> <th>ITEM #</th> <th>SIZE</th> <th>STYLE</th> <th>COLOR</th> </tr> </thead> <tbody> <tr> <td>19057</td> <td>—</td> <td>Buckle</td> <td>Black</td> </tr> </tbody> </table>				ITEM #	SIZE	STYLE	COLOR	19057	—	Buckle	Black
ITEM #	SIZE	STYLE	COLOR								
19057	—	Buckle	Black								
// PATENT PENDING											

		3115	ORDER MULTIPLE 6												
WRIST TOOL LANYARD															
<ul style="list-style-type: none"> • Polyester webbing cuff secures to wrist • Energy-absorbing ribbed pull cord • Adjustable barrel lock for tool attachment • Short length improves the drop clearance needed • Wrist Measurement: S/M 5" – 7" (13cm – 18cm) • Wrist Measurement: L/XL 7" – 8½" (18cm – 22cm) 															
<table border="1"> <thead> <tr> <th>ITEM #</th> <th>SIZE</th> <th>STYLE</th> <th>COLOR</th> </tr> </thead> <tbody> <tr> <td>19042</td> <td>S/M</td> <td>Adj.</td> <td>Black</td> </tr> <tr> <td>19052</td> <td>L/XL</td> <td>Adj.</td> <td>Black</td> </tr> </tbody> </table>				ITEM #	SIZE	STYLE	COLOR	19042	S/M	Adj.	Black	19052	L/XL	Adj.	Black
ITEM #	SIZE	STYLE	COLOR												
19042	S/M	Adj.	Black												
19052	L/XL	Adj.	Black												

		3130	ORDER MULTIPLE 1												
COIL TOOL LANYARD															
<ul style="list-style-type: none"> • Constructed with PU covered aircraft cable • Stainless steel carabiners (#304) • Coil design prevents snag and tangle hazards • Swiveling design prevents tangles and fast recoil • Extended length 51" (129cm) 															
<table border="1"> <thead> <tr> <th>ITEM #</th> <th>SIZE</th> <th>STYLE</th> <th>COLOR</th> </tr> </thead> <tbody> <tr> <td>19130</td> <td>S</td> <td>Coil</td> <td>HV Lime</td> </tr> <tr> <td>19131</td> <td>M</td> <td>Coil</td> <td>Orange</td> </tr> </tbody> </table>				ITEM #	SIZE	STYLE	COLOR	19130	S	Coil	HV Lime	19131	M	Coil	Orange
ITEM #	SIZE	STYLE	COLOR												
19130	S	Coil	HV Lime												
19131	M	Coil	Orange												
// PATENT PENDING															

		3175	ORDER MULTIPLE 6						
ACCESSORY ANCHOR									
<ul style="list-style-type: none"> • Heavy-duty 45mm polyester webbing • Nickel-plated iron D-Ring • 840D nylon wear protector sleeve • Not for climbing or fall arrest 									
<table border="1"> <thead> <tr> <th>ITEM #</th> <th>SIZE</th> <th>COLOR</th> </tr> </thead> <tbody> <tr> <td>19175</td> <td>—</td> <td>Black</td> </tr> </tbody> </table>				ITEM #	SIZE	COLOR	19175	—	Black
ITEM #	SIZE	COLOR							
19175	—	Black							

OFFICIAL PRODUCT REVIEW

TENACIOUS TESTER™
APPROVED

unscripted • unbiased • unabashed

TESTER: KIRK MEYER

PRODUCT: 3150

“First off, I believe this is one of the gutsiest pieces of PPE out there (for now)! The bright yellow, makes it easy to find among all your other gear. This lanyard has some very practical applications too, one of which I saw just last week; a laborer bumped his head on some rebar, and his hard hat fell splat - into wet concrete.”

ONE WORD REVIEW: PRACTICAL

3150

ORDER
MULTIPLE
6

ELASTIC HARD HAT LANYARD-BUCKLE

MAXIMUM LOAD LIMIT
2
 POUNDS
(0.9 KG)

- Comfortable high-stretch elastic material
- Easily attaches to hard hats and other headwear
- Double lock plastic buckle attaches to harness

ITEM #	SIZE	COLOR
19150	21.5"	HV Lime

3155

ORDER
MULTIPLE
6

ELASTIC HARD HAT LANYARD-CLAMP

MAXIMUM LOAD LIMIT
2
 POUNDS
(0.9 KG)

- Comfortable high-stretch elastic material
- Easily attaches to hard hats and other headwear
- Quick connect clamp attaches securely to fabric

ITEM #	SIZE	COLOR
19155	23"	HV Lime

3386

ORDER
MULTIPLE
6

ID & BADGE HOLDER

- Durable vinyl construction
- Protects ID badge
- Fits 4.75" x 3" (12.1cm x 7.6cm) ID

ITEM #	SIZE	COLOR
19950	12" - 18"	Black

3157

ORDER
MULTIPLE
6

COIL HARD HAT LANYARD-BUCKLE

MAXIMUM LOAD LIMIT
2
 POUNDS
(0.9 KG)

- Low-profile durable plastic coil
- Easily attaches to hard hats and other headwear
- Coil design prevents snag and tangle hazards
- Double lock plastic buckle attaches to harness

ITEM #	SIZE	COLOR
19156	18"	Black
19157	18"	HV Lime

3158

ORDER
MULTIPLE
6

COIL HARD HAT LANYARD-CLAMP

MAXIMUM LOAD LIMIT
2
 POUNDS
(0.9 KG)

- Low-profile durable plastic coil
- Easily attaches to hard hats and other headwear
- Coil design prevents snag and tangle hazards
- Quick connect clamp attaches securely to fabric

ITEM #	SIZE	COLOR
19158	13"	Black
19159	13"	HV Lime

3386_{HV}

ORDER
MULTIPLE
6

HI-VIS ID & BADGE HOLDER

- Durable vinyl construction
- Hi-Visibility elastic armband with hook and loop
- Protects ID badge
- Fits 4.75" x 3" (12.1cm x 7.6cm) ID

ITEM #	SIZE	COLOR
19951	12" - 18"	HV Orange

squids LANYARDS & ORGANIZERS

SQUIDS® LANYARDS:

RETRACTOR SERIES

DIFFERENTIATED BY DESIGN



ABS THERMOPLASTIC HOUSING

Outer shell of retractor holds up to the elements and the beating it takes hanging onto tools you cherish.

3001

SELF-SETTING LENGTH

Self-setting pawls set desired lanyard length and use a safe one-handed operation to release and retract back into the housing.

MODULAR DESIGN

Tool Tails™ connect to various tools and exchange quickly and securely allowing you to use multiple tools without a tangled mess.



3000
3025

ORDER
MULTIPLE
1

RETRACTABLE TOOL LANYARD - CARABINER



3000

3025



- Self-setting pawls set desired lanyard length
- Modular connecting buckle for exchanging tools
- Plated swiveling ring for 360° rotation
- Manual locking stainless steel carabiners (#304)
- Technora cord for ultimate strength and durability

3000: CARABINER

ITEM #	COLOR
19300	Black

3025: EXTRA TAILS (3 PK.)

ITEM #	COLOR
19325	Black

// PATENTED



3001
3026

ORDER
MULTIPLE
1

RETRACTABLE TOOL LANYARD - LOOP

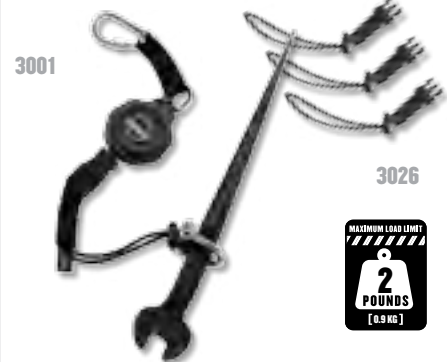

3001

3026



- Self-setting pawls set desired lanyard length
- Modular connecting buckle for exchanging tools
- Plated swiveling ring for 360° rotation
- Loop and manual locking stainless carabiner (#304)
- Technora cord for ultimate strength and durability

3001: LOOP

ITEM #	COLOR
19301	Black

3026: EXTRA TAILS (3 PK.)

ITEM #	COLOR
19326	Black

// PATENTED

IN THE U.S. IN 2014, THERE WERE
503 FATALITIES
 FROM BEING STRUCK BY AN OBJECT OR EQUIPMENT
 [509 IN 2013]



243 WERE CAUSED BY A FALLING OBJECT [245 IN 2013]

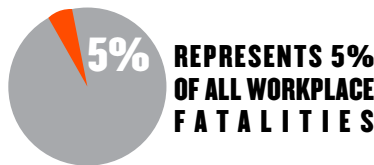
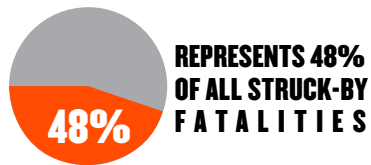

2014 **NONFATAL OCCUPATIONAL INJURIES** IN THE U.S. PRIVATE SECTOR



42,400 STRUCK BY FALLING OBJECT OR EQUIPMENT

REPRESENTS 4.6% OF ALL WORKPLACE INJURIES



A TOP TEN NONFATAL INJURY

AVERAGE COST FOR A **MEDICALLY CONSULTED INJURY:**
\$42,000

AVERAGE COST FOR A **FATAL ACCIDENT:**
\$1.45M

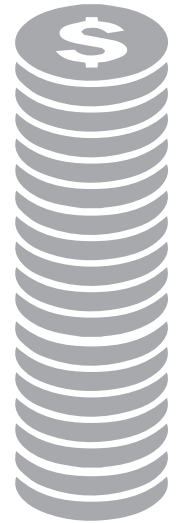

243 FATALITIES [IN 2014] X \$1.45M =

\$352 MILLION \$\$\$\$
 \$\$\$\$

[SOURCE: BLS STATS 2014]

squids LANYARDS & ORGANIZERS

SQUIDS® LANYARD LINEUP



WRIST LANYARDS



RETRACTABLE LANYARDS



COILED LANYARDS



SHOCK ABSORBING ELASTIC LANYARDS



SPECIALTY LANYARDS

SQUIDS® CONNECTOR CLASS



CONNECTOR STYLE: Triple Action with Swivel



CONNECTOR STYLE: Self-Locking



CONNECTOR STYLE: Self-Locking Composite



CONNECTOR STYLE: Manual Lock Stainless Steel



CONNECTOR STYLE: Single-action



CONNECTOR STYLE: Choked Loop

SQUIDS® ORGANIZERS:

GRABBER & ACC. SERIES

DIFFERENTIATED BY DESIGN

MODULAR ANCHORING OPTIONS

Offering a variety of mounts to anchor the grabber to your body or to a static anchor point keeping your gear where you need it, when you need it.

BREAKAWAY DESIGN

All Squids® Grabbers have a breakaway design that disconnects immediately if caught on or in something dangerous - all without damaging the grabber.

INDEPENDENT OPERATION

No matter what mount you choose, the grabber itself can be removed and used independently, attaching to D-rings, keychains, and a variety of your own inherent anchor points.

PATENTED GRABBER DESIGN

Grabber clip holds onto PPE, tools, accessories, and other items preventing dropped, lost, and foreign object concerns.

GRABBER® COLORS:



Black

Blue

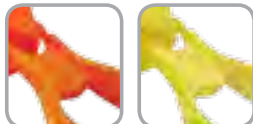

Orange

Lime

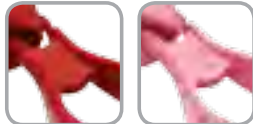

Red

Pink

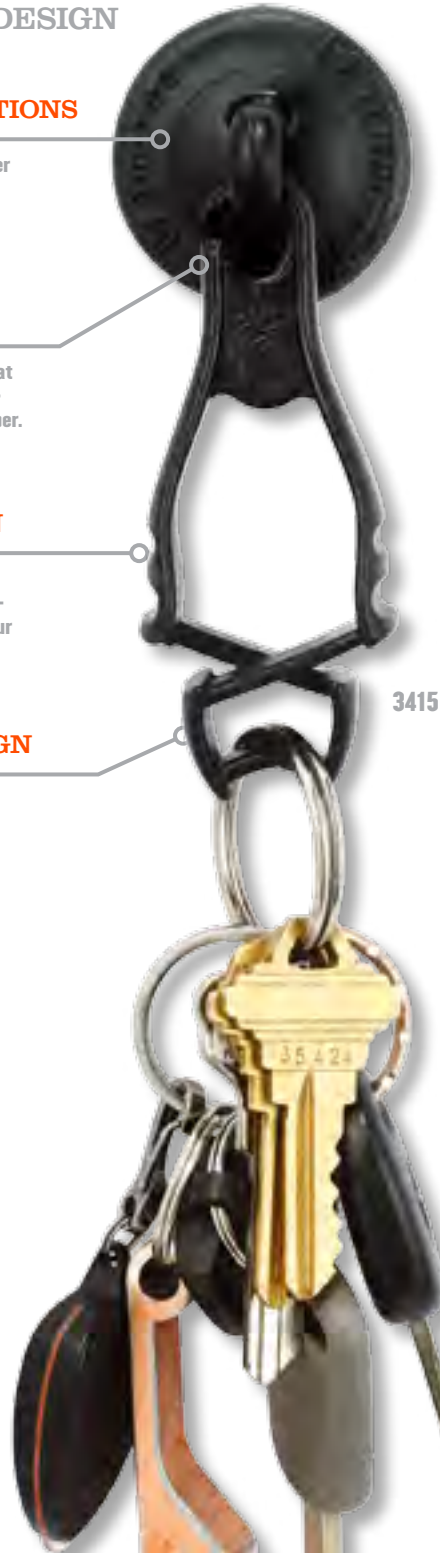

3415



3410

ORDER MULTIPLE 6

GRABBER - SUCTION CUP ANCHOR MOUNT



- Suction cup mounts to clean flat surfaces
- Pull tab allows easy removal from surface
- Anchor to carts, machinery, desks, and equipment
- Dielectric / non-conductive material
- Grabber disconnects allowing independent use

ITEM #	SIZE	COLOR
19321	—	Black

// PATENTED



3415

ORDER MULTIPLE 6

GRABBER - MAGNET ANCHOR MOUNT



- Magnetic anchor mounts to ferromagnetic surfaces
- Soft overmold grabs surface preventing slippage
- Anchor to carts, machinery, desks, and equipment
- Encapsulated magnet protects against corrosion
- Grabber disconnects allowing independent use

ITEM #	SIZE	COLOR
19322	—	Black

// PATENTED

3400

ORDER MULTIPLE
6

GRABBER - DUAL CLIP MOUNT

- Clips to clothing, belts, tool belts, and D-rings
- Holds PPE, tools, accessories, and other items
- Prevents dropped objects and foreign material
- Durable, ultra-resilient acetal copolymer
- Dielectric / non-conductive material

ITEM #	100 PACK ITEM #	COLOR
19112	19112-Bulk	Black
19117	19117-Bulk	Blue
19118	19118-Bulk	HV Orange
19119	19119-Bulk	HV Lime
19113	—	Red
19114	—	Pink

// PATENTED

3405

ORDER MULTIPLE
6

GRABBER - BELT CLIP MOUNT

- Clips to belts, tool belts, webbing, and pants
- Holds PPE, tools, accessories, and other items
- Prevents dropped objects and foreign material
- Durable, ultra-resilient acetal copolymer
- Dielectric / non-conductive material

ITEM #	SIZE	COLOR	ITEM #	SIZE	COLOR
19122	—	Black	19129	—	HV Lime
19127	—	Blue	19123	—	Red
19128	—	HV Orange	19124	—	Pink

// PATENTED

3540

ORDER MULTIPLE
6

TIE HOOK - LOCKING HOOK

MAXIMUM LOAD LIMIT
44 POUNDS
 [20 KG]

- Large locking hook with 360° swivel (1.5"/38mm)
- Reusable sliding belt lock mechanism
- High tensile strength, weather resistant nylon 66
- Temp range: -40°F - 176°F (-40°C - 80°C)
- Resistant to oil, salt, solvents, and alkali

ITEM #	SIZE	COLOR
33402	S: 11.8" (30cm) belt	HV Orange
33403	M: 15.8" (40cm) belt	HV Orange
33404	L: 19.7" (50cm) belt	HV Orange

// PATENTED

3400_{MD}

ORDER MULTIPLE
6

METAL DETECTABLE GRABBER - DUAL CLIP MOUNT

- Clips to clothing, belts, tool belts, and D-rings
- Holds PPE, tools, accessories, and other items
- Metal detectable material alerts quality control
- Entire piece impregnated with metallic powder
- Deep blue color signals metal detectability

ITEM #	SIZE	COLOR
19132	—	Deep Blue

// PATENTED

3405_{MD}

ORDER MULTIPLE
6

METAL DETECTABLE GRABBER - BELT CLIP MOUNT

- Clips to belts, tool belts, webbing, and pants
- Holds PPE, tools, accessories, and other items
- Metal detectable material alerts quality control
- Entire piece impregnated with metallic powder
- Deep blue color signals metal detectability

ITEM #	SIZE	COLOR
19142	—	Deep Blue

// PATENTED

3800

ORDER MULTIPLE
12

SQUIDS® CARABINERS

NEW FOR
'17

- Anodized aluminum alloy material
- Durable stainless steel pinned gate
- Grooved carabiner body for better grip w/gloves
- Available in orange or gray body colors

ITEM #	SIZE	COLOR
19882	—	Orange
19883	—	Gray

// PATENTED

squids® LANYARDS & ORGANIZERS

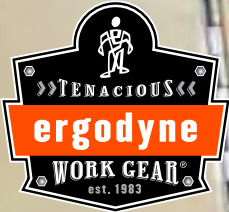

ARROW
CHAMPLAIN
FIRE DEPT

September 11, 2001



GOD BLESS
AMERICA

ARSENAL[®] GEAR STORAGE



**ALL YOUR BAGS ARE PACKED,
YOU'RE READY TO GO...**



ARSENAL® GEAR STORAGE

If you're a graduate of the School of Hard Knocks, then you know your gear won't make it very far in just any old bag. So say goodbye to your run-of-the-mill duffels and say, "whoa" to Arsenal® Gear Storage. These packs, duffels, and buckets are designed, equipped, and tested to handle the toughest curriculum out there: life. Whether you're hoisting, holding, or rolling, ask yourself, "What's in my Arsenal®?"

EQUIPMENT BAGS // PACKS & DUFFEL SERIES



5120 Large Wheeled Gear Bag



5125 Carry-On Luggage



5115/5116 General Duty Bag



5820 Tool Bag Shoulder Strap

EQUIPMENT BAGS // PPE STORAGE SERIES



5080/L SCBA Mask Bag



5082 SCBA Mask Bag



5130 Fall Protection Bag



5180 Half-Mask Respirator Bag

EQUIPMENT BAGS // FIRE & EMS SERIES



5008 Equipment Gear Bag



5005 Large F&R Gear Bag



5005W Wheeled F&R Gear Bag



5005P Large F&R Gear Bag

EQUIPMENT BAGS // FIRE & EMS SERIES



5216 Responder Gear Bag



5215 Large Trauma Bag



5210 Small Trauma Bag



5220 Responder Trauma Bag

EQUIPMENT BAGS // HOIST BUCKET SERIES



5940 Leather Bottom Bucket



5945 Leather Bottom Bucket



5970 Polyester Bucket



5960 D-Ring Leather Bottom Bucket



5143 General Duty Backpack



5144 Mobile Office Backpack



5030 Water-Resistant Duffel



5020P Polyester Duffel



5020 Nylon Duffel



5181 Full-Mask Respirator Bag



5182 Half-Mask Respirator Bag



5183 Full-Mask Respirator Bag



5184 Mouthbit Respirator Bag



5092 Quick Adjust Suspenders



5063 Step-In Gear Bag



5060 Step-In Combo Gear Bag



5244 Responder Backpack



5243 Responder Trauma Backpack



5220 Responder Trauma Bag



5938 Bucket Safety Top



5743 Large Plastic Bottom Bucket



5763 Plastic Bottom Bucket



5734 Small Plastic Bottom Bucket



5738 Bucket Safety Top

ARSENAL® GEAR STORAGE:

PACKS & DUFFEL SERIES

DIFFERENTIATED BY DESIGN

HEAVY-DUTY ZIPPERS

Heavy-duty zippers deliver superb performance and quality.

HEAVY-GAUGE STITCHING

Heavy-gauge stitching provides extra reinforcement and strength around all zippers, pockets, and openings on the bag.

OPEN DESIGN

Open design for maximum storage capacity.

REINFORCED BASE

Lays down a firm foundation and delivers excellent wear and moisture protection for your gear.

MATERIAL BACKING



Material backing provides water protection to keep your gear dry, comfortable, and ready to use.



5120

	5120	ORDER MULTIPLE 1
GENERAL DUTY BAG - LARGE		
 		
<ul style="list-style-type: none"> • 600D polyester main material • Padded and adjustable shoulder strap • Molded wheels for safe and easy transport • Molded retractable pull handle • 32.5"L x 14"W x 12.5"H (83cm x 35cm x 32cm) 		
ITEM #	SIZE	COLOR
13120	5688ci (93 l)	Black

	5125	ORDER MULTIPLE 1
CARRY-ON LUGGAGE		
 		
<ul style="list-style-type: none"> • 1680D ballistic polyester • Molded retractable pull handle • Rugged construction with extra bartacks and nylon • Molded wheels for safe and easy transport • 14"L x 9"W x 22.5"H (36cm x 23cm x 57cm) 		
ITEM #	SIZE	COLOR
13125	2835ci (46 l)	Black

	5115/5116	ORDER MULTIPLE 1			
GENERAL DUTY BAG					
 					
<ul style="list-style-type: none"> • 600D polyester main material • Heavy-duty PP webbing for structure and durability • Water repellent backing on main material • Padded and adjustable shoulder strap • 5116: 23.5"L x 9.5"W x 12"H (60cm x 24cm x 30cm) • 5115: 17.5"L x 8.5"W x 10"H (45cm x 22cm x 25cm) 					
ITEM #	SIZE	COLOR	ITEM #	SIZE	COLOR
13016	2679ci (44 l)	Black	13015	1488ci (24 l)	Black

	5143	ORDER MULTIPLE 1
--	-------------	---------------------

GENERAL DUTY BACKPACK

PRODUCT AVAILABLE
CUSTOM LOGGING

- 600D polyester main material
- Rucksack design for maximum storage
- Top cover flap for protection from the elements
- Padded computer sleeve in main pouch
- 15"L x 8"W x 19"H (38cm x 20cm x 48cm)

ITEM #	SIZE	COLOR
13043	2280ci (37 l)	Black

	5030	ORDER MULTIPLE 1
--	-------------	---------------------

WATER RESISTANT DUFFEL BAG

PRODUCT AVAILABLE
CUSTOM LOGGING

- Water-resistant tarpaulin w/ 1000D poly mesh
- Shoulder straps carry as duffel or backpack
- Four compression straps and two haul handles
- Open design for maximum storage capacity
- S: 23.5"L x 12"W x 11"H (60cm x 30cm x 28cm)
- M: 27"L x 13.5"W x 12"H (69cm x 34cm x 30cm)
- L: 30.5"L x 15"W x 15"H (77cm x 38cm x 38cm)

ITEM #	SIZE	COLOR	ITEM #	SIZE	COLOR
13030	3102ci (51 l)	Black	13034	6263ci (112 l)	Black
13032	4374ci (72 l)	Black			

	5020P	ORDER MULTIPLE 1
--	--------------	---------------------

POLYESTER DUFFEL BAG

PRODUCT AVAILABLE
CUSTOM LOGGING

- 600D Polyester
- Heavy-duty ribbed straps on top and side
- Heavy-duty #8 zippers
- Removable shoulder strap and strap grabber
- S: 23"L x 12"W x 12"H (58cm x 30cm x 30cm)
- M: 28.5"L x 13"W x 13"H (73cm x 33cm x 33cm)
- L: 35"L x 14"W x 14"H (89cm x 36cm x 36cm)

ITEM #	SIZE	COLOR	ITEM #	SIZE	COLOR
13320	2600 ci (44 l)	Black	13322	6300 ci (104 l)	Black
13321	3800 ci (63 l)	Black			

	5144	ORDER MULTIPLE 1
--	-------------	---------------------

MOBILE OFFICE BACKPACK

UPDATED FOR '17

PRODUCT AVAILABLE
CUSTOM LOGGING

- 1200D polyester material
- Four main compartments, two vertical side pockets
- Personal items pocket with headphones port
- Cushioned back padding with airflow design
- 14"L x 8"W x 20"H (36cm x 20cm x 51cm)

ITEM #	SIZE	COLOR
13044	2240ci (37 l)	Black

	5020	ORDER MULTIPLE 1
--	-------------	---------------------

NYLON DUFFEL BAG

PRODUCT AVAILABLE
CUSTOM LOGGING

- 600D nylon body material
- Heavy-duty ribbed straps on top and side
- Heavy-duty #8 zippers
- Removable shoulder strap and strap grabber
- S: 23"L x 12"W x 12"H (58cm x 30cm x 30cm)
- M: 28.5"L x 13"W x 13"H (73cm x 33cm x 33cm)
- L: 35"L x 14"W x 14"H (89cm x 36cm x 36cm)

ITEM #	SIZE	COLOR	ITEM #	SIZE	COLOR
13020	2600ci (44 l)	Red	13022	6300ci (104 l)	Red
13021	3800ci (63 l)	Red			

	5820	ORDER MULTIPLE 1
--	-------------	---------------------

REPLACEMENT GEAR/TOOL BAG SHOULDER STRAP

NEW FOR '17

- Heavy-duty padded and adjustable shoulder strap
- Reinforced stitching
- Compatible with most over the shoulder bags

ITEM #	SIZE	COLOR
13820	54" (137cm)	Black

ARSENAL® GEAR STORAGE:

PPE STORAGE SERIES

DIFFERENTIATED BY DESIGN

ATTACHMENT OPTIONS

Hooks, waist straps, and belt loops give a variety of options for carrying.



5082

HEAVY-DUTY FABRICS

Heavy-duty woven fabric is extremely abrasion resistant.

OPEN DESIGN

Open design easily fits most standard half and full masks.

5080/5080L			ORDER MULTIPLE 1
SCBA MASK BAG			
<ul style="list-style-type: none"> • 1000D nylon main material • Drawstring/Loop access with one-handed operation • Reflective strip for better visibility • Steel clasp to attach to bag, belt, or other gear • ID window for user identification • 5080L: Features brushed polyester fleece lining • 8.5"L x 8.5"W x 11.5"H (21cm x 21cm x 29cm) 			
5080:	5080L:		
ITEM #	SIZE	COLOR	ITEM #
13080	650ci (11 l)	Red	13081
			650ci (11 l)
			Red

5082			ORDER MULTIPLE 1
SCBA MASK BAG			
<ul style="list-style-type: none"> • 1000D nylon main material • Bottom access drops mask into user's hand • Reflective strip for better visibility • Steel clasp to attach to bag, belt, or other gear • ID window for user identification • 8.5"L x 8.5"W x 14.5"H (21cm x 21cm x 36cm) 			
ITEM #	SIZE	COLOR	
13082	650ci (11 l)	Red	

5092/5093			ORDER MULTIPLE 1
PADDED QUICK ADJUST SUSPENDERS			
<ul style="list-style-type: none"> • 600D nylon body material • Heavy-duty polyester webbing • "H" back design • Foam padded shoulder straps • 5093: Features reflective stripes 			
5092:	5093: REFLECTIVE		
ITEM #	SIZE	COLOR	ITEM #
13339	30" (76cm)	Red	13349
			30" (76cm)
			Red
13340	36" (91cm)	Red	13350
			36" (91cm)
			Red
13341	42" (106cm)	Red	13351
			42" (106cm)
			Red
13342	48" (121cm)	Red	13352
			48" (121cm)
			Red

	5180	ORDER MULTIPLE 1
HALF-MASK RESPIRATOR WAIST PACK		
<ul style="list-style-type: none"> • 420D nylon • Plastic buckle closure on waist strap • Cover flap with hook and loop closure • 7.5"L x 3.5"W x 6"H (19cm x 8cm x 15cm) 		
ITEM #	SIZE	COLOR
13180	135ci (2.2 l)	Black

	5181	ORDER MULTIPLE 1
FULL-FACE RESPIRATOR BAG		
<ul style="list-style-type: none"> • 420D nylon • Hook and loop allows for easy attachment • Cover flap with hook and loop closure • 10"L x 3.5"W x 6"H (25cm x 9cm x 15cm) 		
ITEM #	SIZE	COLOR
13181	190ci (3 l)	Black

	5182	ORDER MULTIPLE 1
HALF-MASK RESPIRATOR BAG		
<ul style="list-style-type: none"> • 420D nylon • Hook and loop allows for easy attachment • Cover flap with hook and loop closure • 8.5"L x 3"W x 7"H (22cm x 8cm x 18cm) 		
ITEM #	SIZE	COLOR
13182	145ci (2.4 l)	Black

	5183	ORDER MULTIPLE 1
FULL-MASK RESPIRATOR BAG		
<ul style="list-style-type: none"> • 420D nylon • Hook and loop allows for easy attachment • Cover flap with hook and loop closure • 9.5"L x 4"W x 12"H (24cm x 10cm x 30cm) 		
ITEM #	SIZE	COLOR
13183	300ci (5 l)	Black

	5184	ORDER MULTIPLE 1
MOUTHBIT RESPIRATOR WAIST PACK		
<ul style="list-style-type: none"> • 420D nylon • Plastic buckle closure on waist strap • Cover flap with hook and loop closure • 5"L x 4"W x 6.5"H (13cm x 10cm x 17cm) 		
ITEM #	SIZE	COLOR
13184	100ci (1.6 l)	Black

	5130	ORDER MULTIPLE 1
FALL PROTECTION BAG		
<ul style="list-style-type: none"> • 600D polyester • Drawstring opening and barrel lock closure • Webbing carry strap handle, grommets drain hole • Flap to protect from dust-filled environments • 10"L x 10"W x 15"H (26cm x 26cm x 38cm) 		
ITEM #	SIZE	COLOR
13130	1,100ci (18 l)	Black

* Note: respirators not included... Duh!

ARSENAL® GEAR STORAGE:

FIRE & EMS SERIES

DIFFERENTIATED BY DESIGN

ADJUSTABLE PADDED SHOULDER STRAPS

All Arsenal® Fire and Equipment Bags come with removable shoulder straps that adjust to your preferred length and include a shoulder pad for carrying.

HEAVY-DUTY ZIPPERS

Industrial grade double-pull zippers with improved pull tabs mean reliability and performance over the long haul; double-pulls also allow secure locking.

HEAVY-DUTY FABRICS

Abrasion resistant woven fabrics with water resistant backing; some styles offer reinforced tarpaulin base fabric to take on the wear and tear you put it through.



SIZE



Arsenal® Fire and Equipment Bags offer the size you need for all your turnout gear, tower gear, or whatever else you need to haul.

LOGO READY

Maltese cross or other logo can be applied to any bag.



FIND OUT MORE ABOUT THE TECHNOLOGY THAT GOES INTO
THE FULL LINE OF ERGODYNE GEAR STORAGE AT: WWW.ERGODYNE.COM

	5008	ORDER MULTIPLE 1
FIRE & SAFETY GEAR BAG		
 		
<ul style="list-style-type: none"> • 1000D polyester main material • Tarpaulin reinforced bottom with molded feet • 360° grab handles for hauling from any angle • Massive side pocket and two accessory pockets • 31"L x 16"W x 15.5"H (79cm x 41cm x 39cm) 		
ITEM #	SIZE	COLOR
13009	7688ci (126 l)	Black
13008	7688ci (126 l)	Red

	5005	ORDER MULTIPLE 1
LARGE F&R GEAR BAG		
 		
<ul style="list-style-type: none"> • 1000D nylon • Heavy-duty #10 zippers • 2" webbing handle and shoulder straps • Grab-and-go pull strap and removable shoulder strap • 30"L x 15"W x 15"H (76cm x 38cm x 38cm) 		
ITEM #	SIZE	COLOR
13005	6750ci (111 l)	Red

	5005_w	ORDER MULTIPLE 1
WHEELED F&R GEAR BAG		
 		
<ul style="list-style-type: none"> • 1000D nylon • Heavy-duty #10 zippers • 2" webbing handle and shoulder straps • Grab-and-go pull strap and removable shoulder strap • 31"L x 14"W x 14"H (79cm x 36cm x 36cm) 		
ITEM #	SIZE	COLOR
13205	6076ci (100 l)	Red

	5005_p	ORDER MULTIPLE 1
LARGE F&R GEAR BAG		
 		
<ul style="list-style-type: none"> • 1000D polyester • Heavy-duty #10 zippers • 2" webbing handle and shoulder straps • Grab-and-go pull strap and removable shoulder strap • 30"L x 15"W x 15"H (76cm x 38cm x 38cm) 		
ITEM #	SIZE	COLOR
13305	6750ci (100 l)	Red

	5060	ORDER MULTIPLE 1
THREE-COMPARTMENT STEP-IN GEAR BAG		
 		
<ul style="list-style-type: none"> • 1000D nylon • Removable shoulder strap and strap grabber • Heavy-duty #10 zippers • Maltese cross • 29"L x 15"W x 15"H (74cm x 38cm x 38cm) 		
ITEM #	SIZE	COLOR
13060	6525ci (107 l)	Red

	5063	ORDER MULTIPLE 1
CENTER OPENING STEP-IN GEAR BAG		
 		
<ul style="list-style-type: none"> • 1000D nylon • 2" webbing handle and shoulder straps • Heavy-duty #10 zippers • Maltese cross • 20"L x 18"W x 15"H (51cm x 46cm x 38cm) 		
ITEM #	SIZE	COLOR
13063	5400ci (88 l)	Red

ARSENAL® GEAR STORAGE:

FIRE & EMS SERIES

DIFFERENTIATED BY DESIGN

HEAVY-DUTY ZIPPERS

Industrial grade double-pull zippers with improved pull tabs mean reliability and performance over the long haul; double-pulls also allow secure locking.

WIDE-MOUTH OPENINGS

Main compartments consist of wide access openings making it easy for you to find and access equipment.



5216

INTERNAL DIVIDERS

Transitional internal dividers can be set up to your liking, compartmentalizing your responder equipment.

REFLECTIVE STRIPING

Hi-Vis reflective striping allows for better visibility.

PALS WEBBING SLOTS

Interior and exterior slotted webbing for storage of tools you need when the time comes.



FIND OUT MORE ABOUT THE TECHNOLOGY THAT GOES INTO
THE FULL LINE OF ERGODYNE GEAR STORAGE AT: WWW.ERGODYNE.COM

   	5216	ORDER MULTIPLE 1
RESPONDER GEAR BAG		
		
<ul style="list-style-type: none"> • 600D polyester main material • Tarpaulin reinforced bottom with molded feet • Large clamshell side pockets drop down • Top grab handles for rapid response clutch and go • 25.5"L x 14.5"W x 10.5"H (65cm x 37cm x 27cm) 		
ITEM #	SIZE	COLOR
13447	3882ci (64 l)	Blue

  	5215	ORDER MULTIPLE 1
LARGE RESPONDER TRAUMA BAG		
		
<ul style="list-style-type: none"> • 600D polyester w/ reinforced backing • Adjustable internal dividers • Reflective stripe • Blue or Orange • 19"L x 12"W x 8.5"H (48cm x 30cm x 22cm) 		
ITEM #	SIZE	COLOR
13437	1938ci (32 l)	Blue
13438	1938ci (32 l)	Orange

  	5210	ORDER MULTIPLE 1
SMALL RESPONDER TRAUMA BAG		
		
<ul style="list-style-type: none"> • 600D polyester w/ reinforced backing • ID card window • Reflective stripe • Blue or Orange • 16.5"L x 10"W x 7"H (42cm x 25cm x 18cm) 		
ITEM #	SIZE	COLOR
13417	1155ci (19 l)	Blue
13418	1155ci (19 l)	Orange

   	5244	ORDER MULTIPLE 1
RESPONDER BACKPACK		
		
<ul style="list-style-type: none"> • 600D polyester main material • Tarpaulin reinforced bottom with molded feet • Cushioned mesh padding for comfort • Front compression straps to hold blanket, etc. • 14.5"L x 5"W x 20"H (37cm x 13cm x 51cm) 		
ITEM #	SIZE	COLOR
13497	1450ci (24 l)	Blue

  	5243	ORDER MULTIPLE 1
RESPONDER TRAUMA BACKPACK		
		
<ul style="list-style-type: none"> • 600D polyester w/ reinforced backing • 3" padded shoulder straps w/ reflective striping • Phone holder • Heavy-duty carry handle • 12"L x 7"W x 17.5"H (31cm x 18cm x 44cm) 		
ITEM #	SIZE	COLOR
13487	1470ci (24 l)	Blue
13488	1470ci (24 l)	Orange

  	5220	ORDER MULTIPLE 1
RESPONDER TRAUMA BAG		
		
<ul style="list-style-type: none"> • 600D polyester w/ reinforced backing • Six division, multi-tiered mesh interior pocket • ID card window • Blue or Orange • 16.5"L x 7.5"W x 10"H (42cm x 19cm x 25cm) 		
ITEM #	SIZE	COLOR
13457	1238ci (20 l)	Blue
13458	1238ci (20 l)	Orange

ARSENAL® GEAR STORAGE:

HOIST BUCKET SERIES

DIFFERENTIATED BY DESIGN

THIRD-PARTY CERTIFIED TO A 5:1 SAFETY FACTOR

Haul your gear safely and confidently knowing it's third-party certified to a 5:1 safety factor.

HEAVY-GAUGE STITCHING

Heavy-gauge nylon stitching provides extra reinforcement and strength around all zippers, pockets, and openings on the bag.

PATENTED SAFETY TOP

Patented safety top closure buckles around handles of bucket to secure contents inside.

DURABLE FABRICS

Heavy-duty canvas is extremely abrasion resistant.

REINFORCED BOTTOM

Lays down a firm foundation and delivers excellent wear and moisture protection for your tools.



5960T

				<h1>5940</h1>		ORDER MULTIPLE 1
LEATHER BOTTOM CANVAS - SWIVELING CARABINER						
<ul style="list-style-type: none"> • 24oz canvas • Synthetic leather bottom • Reinforced webbing handle • Double action carabiner with captive eye • 12.5"D x 17"H (32cm x 43cm) 						
SWIVEL CARABINER			SWIVEL 'BINER W/TOP			
ITEM #	SIZE	COLOR	ITEM #	SIZE	COLOR	
14940	L	Gray	14840	L	Gray	

				<h1>5930</h1>		ORDER MULTIPLE 1
LEATHER BOTTOM CANVAS						
<ul style="list-style-type: none"> • 24oz canvas • Synthetic leather bottom • Reinforced webbing handle • Storm drain for ventilation • 12.5"D x 17"H (32cm x 43cm) 						
WEB HANDLE			WEB HANDLE W/TOP			
ITEM #	SIZE	COLOR	ITEM #	SIZE	COLOR	
14930	L	Gray	14830	L	Gray	

* Note: lanyards and tools not included... Duh!

5945

ORDER MULTIPLE
1

XL-LEATHER BOTTOM CANVAS - SWIVELING CARABINER

- 24oz canvas
- Synthetic leather bottom
- Reinforced webbing handle
- Double-action carabiner with captive eye
- 16"D x 20"H (41cm x 51cm)

XL SWIVEL CARABINER

ITEM #	SIZE	COLOR
14945	XL	Gray

XL SWIVEL 'BINER W/TOP

ITEM #	SIZE	COLOR
14845	XL	Gray

// PATENTED

5970

ORDER MULTIPLE
1

POLYESTER BUCKET - SWIVELING HOOK

- 900D polyester main material
- 1680D PU bottom
- Reinforced webbing handle
- Nickel-plated swivel clip
- 12.5"D x 15"H (32cm x 38cm)

SWIVEL SNAP

ITEM #	SIZE	COLOR
14970	L	Black

SWIVEL SNAP W/TOP

ITEM #	SIZE	COLOR
14870	L	Black

// PATENTED

5960

ORDER MULTIPLE
1

LEATHER BOTTOM CANVAS D-RINGS

- 24oz canvas
- Synthetic leather bottom
- Reinforced webbing handle
- Three zinc-plated D-rings
- 12.5"D x 17"H (32cm x 43cm)

WEB HANDLE W/D-RINGS

ITEM #	SIZE	COLOR
14960	L	Gray

WEB D-RINGS W/TOP

ITEM #	SIZE	COLOR
14860	L	Gray

// PATENTED

5935

ORDER MULTIPLE
1

XL-LEATHER BOTTOM CANVAS

- 24oz canvas
- Leather reinforced base
- Nickel-plated swivel clip
- PP rope handle
- 16" diameter (41cm), 20" height (51cm)

XL WEB HANDLE

ITEM #	SIZE	COLOR
14935	XL	Gray

XL WEB HANDLE W/TOP

ITEM #	SIZE	COLOR
14835	XL	Gray

// PATENTED

5975

ORDER MULTIPLE
1

POLYESTER BUCKET

- 900D polyester main material
- 1680D PU bottom
- Reinforced webbing handle
- Storm drain for ventilation
- 12.5"D x 15"H (32cm x 38cm)

WEB HANDLE

ITEM #	SIZE	COLOR
14975	L	Black

WEB HANDLE W/TOP

ITEM #	SIZE	COLOR
14875	L	Black

// PATENTED

5937/5938

ORDER MULTIPLE
1

BUCKET SAFETY TOP - POLYESTER

5937

5938

- 900D polyester main material
- Best in class YKK buckles
- Reinforced stitching
- 5938: 12.5"D (32cm)
- 5937: 16"D (41cm)

ITEM #	SIZE	COLOR
14938	12.5"D (32cm)	Black
14937	16.5"D (41cm)	Black

ARSENAL GEAR STORAGE

		5760	ORDER MULTIPLE 1
HEAVY-DUTY CANVAS			
			
			
<ul style="list-style-type: none"> • 20oz canvas • Leather reinforced base • Zinc-plated alloy steel D-ring on handle • Zinc-plated alloy steel D-rings built into handle • 12.5" diameter (32cm), 17" height (43cm) 			
WEB HANDLE W/D-RINGS		WEB D-RINGS W/TOP	
ITEM #	SIZE	COLOR	ITEM #
14460	Std.	White	14560
// PATENTED			

		5763	ORDER MULTIPLE 1
HEAVY-DUTY CANVAS BUCKET			
			
			
<ul style="list-style-type: none"> • 18oz canvas • Molded plastic base • Zinc-plated alloy steel D-ring on handle • Interior pocket • 12.5" diameter (32cm), 15" height (38cm) 			
WEB HANDLE W/D-RINGS		WEB W/D-RINGS & TOP	
ITEM #	SIZE	COLOR	ITEM #
14463	Std.	White	14563
// PATENTED			

		5740	ORDER MULTIPLE 1
LEATHER BOTTOM CANVAS			
			
			
<ul style="list-style-type: none"> • 20oz canvas • Leather reinforced base • Nickel-plated swivel clip • PP rope handle • 12.5" diameter (32cm), 17" height (43cm) 			
SWIVEL SNAP		SWIVEL SNAP W/TOP	
ITEM #	SIZE	COLOR	ITEM #
14440	Std.	White	14540
// PATENTED			

		5650	ORDER MULTIPLE 1
HEAVY-DUTY NYLON			
			
			
<ul style="list-style-type: none"> • 840D nylon main material • Leather reinforced base • Zinc-plated alloy steel D-ring on handle • Zinc-plated alloy steel D-rings built into handle • 12.5" diameter (32cm), 17" height (43cm) 			
WEB HANDLE W/D-RINGS		WEB D-RINGS W/TOP	
ITEM #	SIZE	COLOR	ITEM #
14650	Std.	Black	14750
// PATENTED			

		5653	ORDER MULTIPLE 1
HEAVY-DUTY NYLON BUCKET			
			
			
<ul style="list-style-type: none"> • 840D nylon main material • Molded plastic base • Zinc-plated alloy steel D-ring on handle • Interior pocket • 12.5" diameter (32cm), 15" height (38cm) 			
WEB HANDLE W/D-RINGS		WEB W/D-RINGS & TOP	
ITEM #	SIZE	COLOR	ITEM #
14653	Std.	Black	14753
// PATENTED			

		5730	ORDER MULTIPLE 1
LEATHER BOTTOM CANVAS			
			
			
<ul style="list-style-type: none"> • 20oz canvas • Leather reinforced base • Heavy-gauge nylon stitching • PP rope handle • 12.5" diameter (32cm), 17" height (43cm) 			
ROPE HANDLE		ROPE HANDLE W/TOP	
ITEM #	SIZE	COLOR	ITEM #
14430	Std.	White	14530
// PATENTED			

5733

ORDER
MULTIPLE
1

PLASTIC BOTTOM CANVAS BUCKET

MAXIMUM LOAD LIMIT
100
POUNDS
[45 KG]

VOLUME
M

- 18oz canvas
- Molded plastic base
- Heavy-gauge nylon stitching
- PP rope handle
- 12.5" diameter (32cm), 15" height (38cm)

ROPE HANDLE			ROPE HANDLE W/TOP		
ITEM #	SIZE	COLOR	ITEM #	SIZE	COLOR
14433	L	White	14533	L	White

// PATENTED

5744

ORDER
MULTIPLE
1

SMALL PLASTIC BOTTOM CANVAS BUCKET

MAXIMUM LOAD LIMIT
75
POUNDS
[34 KG]

VOLUME
S

- 18oz canvas
- Molded plastic base
- Nickel-plated swivel clip
- PP rope handle
- 10" diameter (25cm), 14" height (36cm)

SWIVEL SNAP			SWIVEL SNAP W/TOP		
ITEM #	SIZE	COLOR	ITEM #	SIZE	COLOR
14444	S	White	14544	S	White

// PATENTED

5737/5738/5739

ORDER
MULTIPLE
1

BUCKET SAFETY TOPS - CANVAS

- 18oz canvas
- Best in class YKK Buckles
- Heavy-gauge nylon stitching
- PP webbing reinforced
- Available in X-Large, Large and Small

ITEM #	SIZE	COLOR
14437	16"D (41cm)	White
14438	12.5"D (32cm)	White
14439	10"D (25cm)	White

// PATENTED

5743

ORDER
MULTIPLE
1

PLASTIC BOTTOM CANVAS BUCKET

MAXIMUM LOAD LIMIT
100
POUNDS
[45 KG]

VOLUME
M

- 18oz canvas
- Molded plastic base
- Nickel-plated swivel clip
- PP rope handle
- 12.5" diameter (32cm), 15" height (38cm)

SWIVEL SNAP			SWIVEL SNAP W/TOP		
ITEM #	SIZE	COLOR	ITEM #	SIZE	COLOR
14443	L	White	14543	L	White

// PATENTED

5745

ORDER
MULTIPLE
1

LEATHER BOTTOM CANVAS - XL

MAXIMUM LOAD LIMIT
150
POUNDS
[68 KG]

VOLUME
XL

- 20oz canvas
- Leather reinforced base
- Nickel-plated swivel clip
- PP rope handle
- 16" diameter (41cm), 20" height (51cm)

SWIVEL SNAP			SWIVEL SNAP W/TOP		
ITEM #	SIZE	COLOR	ITEM #	SIZE	COLOR
14445	XL	White	14545	XL	White

// PATENTED

5638

ORDER
MULTIPLE
1

LARGE BUCKET SAFETY TOP - NYLON

- 840D nylon main material
- Best in class YKK Buckles
- Heavy-gauge nylon stitching
- PP webbing reinforced

ITEM #	SIZE	COLOR
14638	12.5"D (32cm)	Black

// PATENTED



ARSENAL[®]

TOOL STORAGE

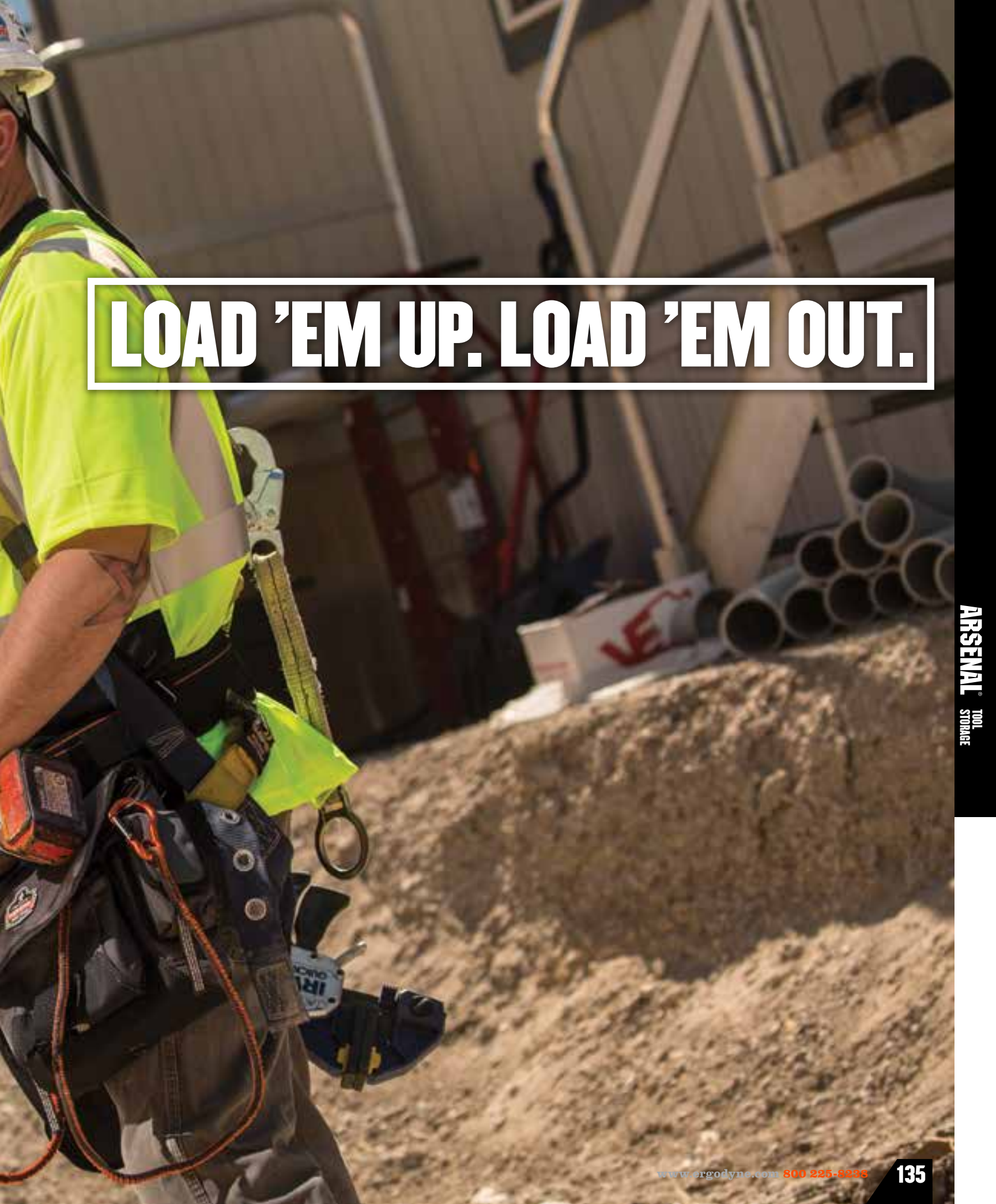

LOAD 'EM UP. LOAD 'EM OUT.

ARSENAL
TOOL
STORAGE



ARSENAL® TOOL STORAGE

Forget your troubles, c'mon get organized. It's easy with Arsenal® Tool Storage. And if you notice any marsupials weeping softly to themselves, well, that's just because they know our pouch game is so, so right. Safely send and store all the knick-knacks and paddy whacks with our wide array of storage options.

TOOL STORAGE // BELT & ACCESSORY SERIES



TOOL STORAGE // BELT & ACCESSORY SERIES

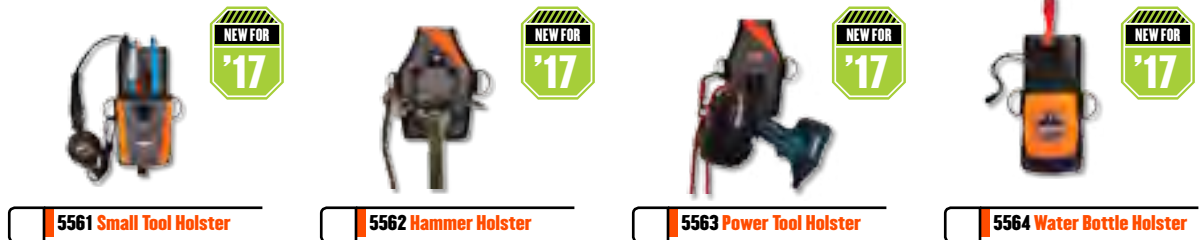

TOOL STORAGE // BELT & ACCESSORY SERIES



TOOL STORAGE // BAG & ORGANIZER SERIES



TOOL STORAGE // BAG & ORGANIZER SERIES





5725 Topped Bolt Bag



5728 Topped Bolt Bag



5518 Topped Tool Pouch



5516 Topped Tool Pouch



5550 3-inch Padded Work Belt



5555 5-inch Padded Work Belt



5560 Tool Belt Suspenders



5700 16-Pocket Apron



5706 13-Pocket Waist Apron



5500 28-Pocket Synthetic Rig



5506S Installer Rig



5804 Small Widemouth Tool Bag



5843 Tool Backpack



5840 Electrician Tool Bag



5810 Open Top Tool Bag



5875 Buddy Organizer



5876 Buddy Organizer



ARSENAL® TOOL STORAGE:

BELT & ACC. SERIES

DIFFERENTIATED BY DESIGN

BELT LOOP ATTACHMENT

Belt loop on back of pouch easily attaches to your belt or fall protection harness, allowing for easy customization to your preference.

NICKEL-PLATED HARDWARE

Nickel-plated hardware is abrasion and corrosion resistant.

DURABLE FABRICS

Heavy-duty woven and tarpaulin fabrics are extremely abrasion resistant.

NICKEL-PLATED STORM DRAIN™

Patented Storm Drains™ keep tools and fasteners ventilated and dry; nickel plating is corrosion resistant to last over the long haul.

D-RINGS FOR TOOL LANYARD ATTACHMENT

D-rings on the interior and exterior for easy tool lanyard attachment for all at heights and FME/FOD applications.



5517

ORDER MULTIPLE
1

PREMIUM TOPPED TOOL POUCH



MAXIMUM LOAD LIMIT
20 POUNDS
[9 KG]

NEW FOR '17

- 1680D ballistic polyester
- 10 pockets for tools and fasteners
- Magnetic hook and loop top closure
- Straps designed for quick attachment and removal
- 13"L x 6"W x 11.5"H (33cm x 15cm x 28cm)

ITEM #	SIZE	COLOR
13647	—	Gray

5527

ORDER MULTIPLE
1

PREMIUM TOPPED PARTS POUCH



MAXIMUM LOAD LIMIT
20 POUNDS
[9 KG]

NEW FOR '17

- 1680D ballistic polyester
- Snap-hinge closure for safety and security
- Two exterior D-rings for tool lanyard attachment
- Straps designed for quick attachment and removal
- 10"L x 6"W x 11.5"H (25cm x 15cm x 29cm)

ITEM #	SIZE	COLOR
13627	—	Gray

5725

ORDER MULTIPLE
1

TOPPED BOLT BAG



MAXIMUM LOAD LIMIT
25 POUNDS
[12 KG]

- 16oz canvas
- One-handed closure for safety
- Nickel-plated rivets
- Two exterior tool loops
- 10"L x 5"W x 9"H (25cm x 13cm x 23cm)

ITEM #	SIZE	COLOR
14425	—	White

5538

ORDER MULTIPLE
1

TOPPED PARTS POUCH



MAXIMUM LOAD LIMIT
20 POUNDS
[9 KG]

- Waterproof tarpaulin material
- Trap door closure for safety and security
- Two exterior tool loops
- Two exterior D-rings for tool lanyard attachment
- 7.5"L x 7.5"W x 12"H (19cm x 19cm x 30cm)

ITEM #	SIZE	COLOR
13638	—	Orange

5528

ORDER MULTIPLE
1

TOPPED PARTS POUCH



MAXIMUM LOAD LIMIT
20 POUNDS
[9 KG]

- 20oz water-resistant canvas
- Trap door closure for safety and security
- Two exterior tool loops
- Two exterior D-rings for tool lanyard attachment
- 7.5"L x 7.5"W x 12"H (19cm x 19cm x 30cm)

ITEM #	SIZE	COLOR
13628	—	Black

5728

ORDER MULTIPLE
1

TOPPED BOLT BAG



MAXIMUM LOAD LIMIT
25 POUNDS
[12 KG]

- 16oz canvas
- One-handed closure for safety
- Nickel-plated rivets
- Two exterior tool loops
- 10"L x 5"W x 13"H (25cm x 13cm x 33cm)

ITEM #	SIZE	COLOR
14428	—	White

	5561	ORDER MULTIPLE 1
SMALL TOOL HOLSTER		
 		
<ul style="list-style-type: none"> • 1680D ballistic polyester • Holds channel locks, pliers, and wrenches • Two D-rings for tool lanyard attachment • Straps designed for quick attachment and removal • 4.5"L x 2.5"W x 8.5"H (11cm x 6cm x 22cm) 		
ITEM #	SIZE	COLOR
13561	—	Gray

	5562	ORDER MULTIPLE 1
HAMMER HOLSTER		
 		
<ul style="list-style-type: none"> • 1680D ballistic polyester • Holds standard hammers and sledges • Two D-rings for tool lanyard attachment • Straps designed for quick attachment and removal • 6"L x 3"W x 8"H (15cm x 8cm x 20cm) 		
ITEM #	SIZE	COLOR
13564	—	Gray

	5563	ORDER MULTIPLE 1
POWER TOOL HOLSTER		
 		
<ul style="list-style-type: none"> • 1680D ballistic polyester • Holds cordless power drills and impact drivers • Two D-rings for tool lanyard attachment • Straps designed for quick attachment and removal • 8"L x 2.5"W x 12"H (20cm x 6cm x 30cm) 		
ITEM #	SIZE	COLOR
13563	—	Gray

	5516	ORDER MULTIPLE 1
TOPPED TOOL POUCH - STRAP DESIGN		
		
<ul style="list-style-type: none"> • 16 pockets for tools and fasteners • Top cover flap with buckle closure • Three nickel-plated D-rings • Strap designed for quick attachment and removal • 11"L x 4.5"W x 11"H (28cm x 11cm x 28cm) 		
ITEM #	SIZE	COLOR
13640	—	Gray

	5518	ORDER MULTIPLE 1
TOPPED TOOL POUCH - LOOP DESIGN		
		
<ul style="list-style-type: none"> • 19 pockets for tools and fasteners • Top cover flap with hook and loop closure • Three nickel-plated D-rings • Belt loop on back attaches to tool belts • 11"L x 4.5"W x 11"H (28cm x 11cm x 28cm) 		
ITEM #	SIZE	COLOR
13642	—	Gray

	5564	ORDER MULTIPLE 1
WATER BOTTLE HOLSTER		
 		
<ul style="list-style-type: none"> • 1680D ballistic polyester • Fits Chill-Its® 5151 Wide Mouth Water Bottle • Two D-rings for tool lanyard attachment • Straps designed for quick attachment and removal • 4"L x 3"W x 9"H (10cm x 8cm x 23cm) 		
ITEM #	SIZE	COLOR
13564	—	Gray

5550

ORDER
MULTIPLE
1

3" TOOL BELT

- Thick, vented foam padding for comfort
- Nickel-plated 2" double tongue metal roller buckle
- Nickel-plated grommets set firmly for durability
- Nickel-plated suspender anchors

ITEM #	SIZE	COLOR
13653	L	Black
13654	XL	Black
13655	2XL	Black

5555

ORDER
MULTIPLE
1

5" TOOL BELT

- Thick, vented foam padding for comfort
- Nickel-plated 2" double tongue metal roller buckle
- Nickel-plated grommets set firmly for durability
- Nickel-plated suspender anchors

ITEM #	SIZE	COLOR	ITEM #	SIZE	COLOR
13656	M	Black	13658	XL	Black
13657	L	Black	13659	2XL	Black

5560

ORDER
MULTIPLE
1

PADDED TOOL BELT SUSPENDERS

- Thick, vented foam padding for comfort
- Gel at key ride points for optimal comfort
- Quick adjust suspender style
- Nickel-plated, spring-loaded, pivoting clips
- Cell phone holder

ITEM #	SIZE	COLOR
13665	—	Gray

ARSENAL® TOOL STORAGE

Have it your way. Build your ideal tool rig with our individual components. Boom.

5517

5562

5528

3770

ARSENAL® TOOL STORAGE



5548

ORDER
MULTIPLE
1

ELECTRICIANS' TOOL POUCH



- Two large main pockets
- Five smaller pockets
- Six large screwdriver slots
- Electrical tape chain and tool spring clip
- 9.5"L x 3.5"W x 12.5"H (33cm x 6cm x 32cm)

ITEM #	SIZE	COLOR
13648	—	Gray



5522

ORDER
MULTIPLE
1

FRAMER/BUILDER TOOL POUCH



- Four main pockets for fasteners and tools
- 12 smaller pockets and tool holders
- Nickel-plated hardware and angled hammer loop
- Detachable tape measure pocket
- 11"L x 5.5"W x 14"H (28cm x 14cm x 36cm)

ITEM #	SIZE	COLOR
13622	—	Gray



5532

ORDER
MULTIPLE
1

FRAMER/BUILDER FASTENER POUCH



- Four main pockets for fasteners and tools
- Seven smaller pockets and tool holders
- Nickel-plated hardware and tape measure clip
- Abrasion-resistant bases with Storm Drains™
- 10"L x 4"W x 14"H (25cm x 10cm x 35cm)

ITEM #	SIZE	COLOR
13632	—	Gray



5567

ORDER
MULTIPLE
1

UTILITY KNIFE HOLDER



- Fits most utility knife designs
- PE-reinforced opening
- Stainless steel belt clip
- Two exterior pen/marker slots
- 2"L x 1"W x 9"H (5cm x 3cm x 23cm)

ITEM #	SIZE	COLOR
13667	—	Gray



5700

ORDER
MULTIPLE
1

16-POCKET APRON



- 14oz 100% cotton duck with reflective trim
- 16-pocket apron features 3-compartment pocket
- Five pockets for larger tools & cell phone
- Eight pockets for pens, pencils, and small tools
- Dual hammer loops

ITEM #	SIZE	COLOR
13690	—	Gray



5706

ORDER
MULTIPLE
1

13-POCKET APRON



- 14oz 100% cotton duck with reflective trim
- 13-pocket waist apron
- Five pockets for larger tools & cell phone
- Eight pockets for pens, pencils, and small tools
- Dual hammer loops

ITEM #	SIZE	COLOR
13695	—	Gray

<p>FRAMER/BUILDER TOOL BELT</p>		<p>5500</p>	<p>ORDER MULTIPLE 1</p>									
<div style="display: flex; justify-content: space-between;"> <div data-bbox="227 327 1112 697"> </div> <div data-bbox="1177 363 1555 520"> <ul style="list-style-type: none"> • 5" padded base layer tool belt (5555) • 16-pocket tool pouch (5522) • Padded suspenders - sold separately (5560) • 11 pocket fastener pouch (5532) • Nickel-plated hammer holder </div> </div> <div style="margin-top: 20px;"> <table border="1" data-bbox="1177 596 1390 663"> <thead> <tr> <th>ITEM #</th> <th>SIZE</th> <th>COLOR</th> </tr> </thead> <tbody> <tr> <td>13601</td> <td>L</td> <td>Gray</td> </tr> <tr> <td>13602</td> <td>XL</td> <td>Gray</td> </tr> </tbody> </table> </div> <p data-bbox="319 663 661 688">* Note: tools and supplies not included... Duh!</p>				ITEM #	SIZE	COLOR	13601	L	Gray	13602	XL	Gray
ITEM #	SIZE	COLOR										
13601	L	Gray										
13602	XL	Gray										

<p>FRAMER/BUILDER TOOL BELT</p>		<p>5504</p>	<p>ORDER MULTIPLE 1</p>									
<div style="display: flex; justify-content: space-between;"> <div data-bbox="256 898 1112 1213"> </div> <div data-bbox="1177 913 1555 1071"> <ul style="list-style-type: none"> • 5" padded base layer tool belt (5555) • Abrasion-resistant reinforced pouch bases • Padded suspenders - sold separately (5560) • Tape holder - large (5571) • Nickel-plated hammer holder </div> </div> <div style="margin-top: 20px;"> <table border="1" data-bbox="1177 1146 1390 1213"> <thead> <tr> <th>ITEM #</th> <th>SIZE</th> <th>COLOR</th> </tr> </thead> <tbody> <tr> <td>13615</td> <td>L</td> <td>Gray</td> </tr> <tr> <td>13616</td> <td>XL</td> <td>Gray</td> </tr> </tbody> </table> </div> <p data-bbox="319 1213 661 1239">* Note: tools and supplies not included... Duh!</p>				ITEM #	SIZE	COLOR	13615	L	Gray	13616	XL	Gray
ITEM #	SIZE	COLOR										
13615	L	Gray										
13616	XL	Gray										

<p>INSTALLER/DRILL HOLDER TOOL RIG WITH SUSPENDERS</p>		<p>5506_s</p>	<p>ORDER MULTIPLE 1</p>									
<div style="display: flex; justify-content: space-between;"> <div data-bbox="256 1392 1130 1812"> </div> <div data-bbox="1177 1465 1555 1623"> <ul style="list-style-type: none"> • 5" padded base layer tool belt (5555) • Aerial tool pouch with safety top (5518) • Reinforced bindings, semi-rigid • Ambidextrous drill holder pouch • Padded, quick-adjust suspenders included </div> </div> <div style="margin-top: 20px;"> <table border="1" data-bbox="1177 1698 1390 1766"> <thead> <tr> <th>ITEM #</th> <th>SIZE</th> <th>COLOR</th> </tr> </thead> <tbody> <tr> <td>13612</td> <td>L</td> <td>Gray</td> </tr> <tr> <td>13613</td> <td>XL</td> <td>Gray</td> </tr> </tbody> </table> </div> <p data-bbox="319 1766 661 1791">* Note: tools and supplies not included... Duh!</p>				ITEM #	SIZE	COLOR	13612	L	Gray	13613	XL	Gray
ITEM #	SIZE	COLOR										
13612	L	Gray										
13613	XL	Gray										



FIND OUT MORE ABOUT THE TECHNOLOGY THAT GOES INTO THE FULL LINE OF ERGODYNE TOOL STORAGE AT: WWW.ERGODYNE.COM

ARSENAL® TOOL STORAGE:

BAG & ORGANIZER SERIES

DIFFERENTIATED BY DESIGN

DURABLE FABRICS

Heavy-duty woven fabric is extremely abrasion resistant.

VARIETY OF POCKETS

A large variety of pockets and slots accommodate a wide variety of tools for all kinds of workers.

HEAVY-DUTY ZIPPERS

Heavy-duty zippers deliver superb performance and quality.

D-RINGS FOR ATTACHMENT OF TOOL LANYARD

D-rings on the interior and exterior for easy tool lanyard attachment for all at heights and FME/FOD applications.



5843



			5815	ORDER MULTIPLE 1
OPEN FACE TOOL ORGANIZER - LARGE				
<ul style="list-style-type: none"> • 61 pockets: ultimate in tool organization • Molded-rubber base • Detachable phone holder and parts organizer • Nickel-plated hardware • 18"L x 11"W x 15"H (46cm x 28cm x 38cm) 				
ITEM #	SIZE	COLOR		
13715	L	Gray		

			5817	ORDER MULTIPLE 1
OPEN FACE TOOL ORGANIZER - MEDIUM				
<ul style="list-style-type: none"> • 44 pockets: ultimate in tool organization • Molded-rubber base • Detachable phone holder and parts organizer • Nickel-plated hardware • 15"L x 8.5"W x 13.5"H (38cm x 22cm x 34cm) 				
ITEM #	SIZE	COLOR		
13717	M	Gray		

			5810	ORDER MULTIPLE 1
OPEN TOP TOOL ORGANIZER				
<ul style="list-style-type: none"> • 30 pockets: 21 exterior, 9 interior • Molded-rubber base • Outside tape loop • Nickel-plated hardware • 13"L x 7"W x 9.5"H (33cm x 18cm x 24cm) 				
ITEM #	SIZE	COLOR		
13710	—	Gray		

	5808	ORDER MULTIPLE 1
WIDEMOUTH TOOL ORGANIZER - LONG		
<ul style="list-style-type: none"> • 28 pockets: 12 exterior, 16 interior • Molded-rubber base • Detachable phone holder and parts organizer • Nickel-plated hardware • 24"L x 10"W x 13"H (61cm x 25cm x 33cm) 		
ITEM #	SIZE	COLOR
13708	L	Gray

	5802	ORDER MULTIPLE 1
WIDEMOUTH TOOL ORGANIZER - MEDIUM		
<ul style="list-style-type: none"> • 28 pockets: 14 exterior, 14 interior • Molded-rubber base • Detachable phone holder and parts organizer • Nickel-plated hardware • 14.5"L x 8.5"W x 11"H (37cm x 22cm x 28cm) 		
ITEM #	SIZE	COLOR
13702	M	Gray

	5804	ORDER MULTIPLE 1
WIDEMOUTH TOOL ORGANIZER - SMALL		
<ul style="list-style-type: none"> • 27 pockets: 10 exterior, 17 interior • Molded-rubber base • Detachable phone holder and parts organizer • Nickel-plated hardware • 13.5"L x 7.5"W x 11"H (34cm x 19cm x 28cm) 		
ITEM #	SIZE	COLOR
13704	S	Gray

	5843	ORDER MULTIPLE 1
TOOL BACKPACK		
<ul style="list-style-type: none"> • 26 interior pockets and 7 exterior pockets • Tall tool holster on side panel • Padded shoulder straps for increased comfort • Reinforced comfort padding on the back • 13.5"L x 8.5"W x 18"H (34cm x 22cm x 61cm) 		
ITEM #	SIZE	COLOR
13743	—	Black

	5840	ORDER MULTIPLE 1
ELECTRICIANS' TOOL ORGANIZER		
<ul style="list-style-type: none"> • 48 pockets and holders • Four molded ABS plastic bases • Bio-curved padded shoulder strap and carry handle • Nickel-plated hardware • 11"L x 9"W x 9"W (28cm x 23cm x 23cm) 		
ITEM #	SIZE	COLOR
13740	—	Gray

	5820	ORDER MULTIPLE 1
REPLACEMENT GEAR/TOOL BAG SHOULDER STRAP		
<ul style="list-style-type: none"> • Heavy-duty padded and adjustable shoulder strap • Reinforced stitching • Compatible with most over the shoulder bags 		
ITEM #	SIZE	COLOR
13820	54" (137cm)	Black

ARSENAL TOOL STORAGE

	5870	ORDER MULTIPLE 1
TOOL ROLL-UP		
		
<ul style="list-style-type: none"> • 25 pockets for various tools • Socket pockets holds 3/8" or 1/4" sockets • Carry handle for easy transport • Buckle closure • 27"L x 14.5"H (69cm x 37cm) 		
ITEM #	SIZE	COLOR
13770	—	Gray

	5872	ORDER MULTIPLE 1
WRENCH ROLL-UP		
		
<ul style="list-style-type: none"> • 14 graduated tool slots fit most wrench sets • Fold, roll, and tie for easy transport • Fits 3/8"-1 1/4" or 6mm-32mm wrenches • Nickel-plated grommets for hanging • 26"L x 22"H (67cm x 56cm) 		
ITEM #	SIZE	COLOR
13772	—	Gray

	5888	ORDER MULTIPLE 1
CABLE ORGANIZER		
		
<ul style="list-style-type: none"> • 1680D ballistic polyester • Keeps jumper cables or cords stowed • Exterior pocket for maps, gauges, etc. • Rugged dual webbing handles • 13.5"L x 3.5"H (34cm x 9cm) 		
ITEM #	SIZE	COLOR
13788	—	Gray

	5780	ORDER MULTIPLE 1
CANVAS TOOL ROLL-UP		
		
<ul style="list-style-type: none"> • 16oz canvas • 16 interior pockets • Carry handle for easy transport • Socket pockets holds 3/8" or 1/4" sockets • 22"L x 14.5"H (56cm x 37cm) 		
ITEM #	SIZE	COLOR
14480	—	White

	5782	ORDER MULTIPLE 1
CANVAS WRENCH ROLL-UP		
		
<ul style="list-style-type: none"> • 16oz canvas • 14 graduated tool slots fit most wrench sets • Nickel-plated grommets for hanging • Heavy-gauge nylon stitching • 26.5"L x 16.5"W (67.5cm x 42cm) 		
ITEM #	SIZE	COLOR
14482	—	White

OFFICIAL PRODUCT REVIEW

TENACIOUS TESTER™ APPROVED 

unscripted • unbiased • unabashed

TESTER: BRETT CANTRELL

PRODUCT: 5870

“This is one tenacious tool roll! Found the inside to be water repellent. The dividers for the tool roll are all reinforced at the entry points to add to the longevity of the roll. Love that the interior is a light grey to help in tool identification, as some of the tools I use are mostly black.”

ONE WORD REVIEW: LONGEVITY

• Note: tools and supplies not included... Duh!



5876

ORDER
MULTIPLE
1

BUDDIES ORGANIZER - SMALL

UPDATED FOR
'17

- Clamshell two-pocket open design
- Screened mesh material for visibility
- ID pocket for business cards or labels
- Color coded for easily distinguishing contents
- 7.5"L x 4.5"W x 3"H (19cm x 12cm x 8cm)

ITEM #	SIZE	COLOR	ITEM #	SIZE	COLOR
13220	S	Black	13224	S	Green
13222	S	Blue	13225	S	Yellow
13223	S	Red	13876	S	4-Piece Kit (Red, Yellow, Green, Blue)
13226	S	Orange			

5875

ORDER
MULTIPLE
1

BUDDIES ORGANIZER - LARGE

UPDATED FOR
'17

- Clamshell two-pocket open design
- Screened mesh material for visibility
- ID pocket for business cards or labels
- Color coded for easily distinguishing contents
- 10"L x 4.5"W x 3.5"H (25cm x 12cm x 9cm)

ITEM #	SIZE	COLOR	ITEM #	SIZE	COLOR
13210	L	Black	13214	L	Green
13212	L	Blue	13215	L	Yellow
13213	L	Red	13875	L	4-Piece Kit (Red, Yellow, Green, Blue)
13216	L	Orange			

THE TENACIOUS NATION NEEDS YOU. ENLIST NOW.

Four out of five denizens of the Danger Zone-approved. Here, testing the performance of our products is mission critical. So we're enlisting the services of pros like you to give our stuff a run for its money. Once beaten and mashed, we want the straight dope, so we can improve and continue to deliver the best work gear there is. Give us the truth —we can handle it.

Wanna join the corps? We call 'em Tenacious Testers™. Our exclusive field-testing program specifically designed for those who are grinding it out in the trenches each day (desk jockeys and merchandise slingers need not apply). If accepted into our elite and limited tenacious ranks, you'll receive product to test – but this ain't no free lunch. When you've completed your mission to test and torment our gear without mercy, we expect – nay, demand - a full debriefing of product reviews, photos and video that you'll share on our website. The better you are, the higher you'll fly in the ranks for the initiated. No glass ceilings here. Just a very special opportunity for you to reach the elite ranks and get your opinions, videos, photos, and personage posted, toasted, and respected online and out on the battlefield you call the workzone. Make us proud. Enlist now at www.ergodyne.com.

ARSENAL TOOL STORAGE



ELEMEN



TS



Chill-Its®

- » COOLING PRODUCTS
- » HYDRATION

SHAX®

PORTABLE WORK SHELTERS

- » POP-UP TENTS
- » UMBRELLAS
- » ACCESSORIES

N-FERNO®

- » WARMING PRODUCTS
- » ACCESSORIES

TREX™

- » ICE TRACTION DEVICES





CHILL-ITS®
COOLING PRODUCTS

A STONE COLD CLASSIC.



CHILL-ITS® COOLING PRODUCTS

Our Chill-Its® Cooling Products are cold as ice and you better believe they're willing to sacrifice for your comfort. These babies aren't just a speed bump on the Highway to Hell, either. They're designed to give heat-related illness the cold shoulder and keep your mercury levels just the way you want them. Vests, bandanas, hydration vests, and more. If it cools you down, we're ready to order it up.

COOLING PRODUCTS // EVAPORATIVE SERIES



6700MF Tie Bandana w/ Microfiber



6705MF H&L Bandana w/ Microfiber



6710MF Triangle Hat w/ Microfiber



6602MF Microfiber Towel

COOLING PRODUCTS // EVAPORATIVE SERIES



6717CT Neck Shade w/ Towel



8935CT Ranger Hat w/ Towel



6602 Cooling Towel



6603 Cooling Towel Band

COOLING PRODUCTS // EVAPORATIVE SERIES



6717 Hard Hat Neck Shade w/ Polymers



6700FR Tie Bandana w/ Polymers



6705FR H&L Bandana w/ Polymers



6710FR Triangle Hat w/ Polymers

COOLING PRODUCTS // ABSORPTIVE SERIES



6650 Hat w/ Neck Shade



6615 High-Performance Dew Rag



6630 High-Performance Skull Cap



6605 High-Performance Headband

COOLING PRODUCTS // PHASE CHANGE SERIES



6215 Premium Cooling Vest



6215HV Hi-Vis Premium Cooling Vest



6230 Standard Cooling Vest



6240 Vest Extender Kit



8935MF Ranger Hat w/ Microfiber



6705CT H&L Bandana w/Towel



6710CT Triangle Hat w/ Towel



6715CT Hard Hat Pad w/ Towel



6670CT Neck Shade w/ Towel



6700CT Tie Bandana w/ Towel



6700 Tie Bandana w/ Polymers



6705 H&L Bandana w/ Polymers



6710 Triangle Hat w/ Polymers



6715/6716 Hard Hat w/ Polymers



6717FR HH Neck Shade w/ Polymers



6685 Dry Evaporative Vest



6665 Wet Evaporative Vest



6686 Dry Evaporative Cap



6660 Hard Hat Brim w/ Shade



6500/6550 Terry Elastic Band



6609 Hard Hat Terry Sweatband



6485 Multi-band



6486 Flame Resistant Multi-band

COOLING PRODUCTS // HYDRATION SERIES



5156 Premium Low-Profile



5157 Premium Cargo Hydration



5155HV Hi-Vis Low-Profile Hydration



5158 Hydration Pack Pressure Pump

CHILL-ITS® COOLING:

THE ANATOMY OF CHILL FACTOR X.

COOLING TECHNOLOGY

Using absorbent acrylic polymers, hyper-evaporative PVA, or microfiber material – these products activate easily and quickly to provide a cooling sensation.

SUN PROTECTION

Several Chill-Its® products provide a barrier between you and harmful UV rays.

CONSTRUCTION

Absorbent materials provide super-evaporative cooling for hours by wicking moisture away from the body.



FIND OUT MORE ABOUT THE TECHNOLOGY THAT GOES INTO THE FULL LINE OF ERGODYNE COOLING PRODUCTS AT: WWW.ERGODYNE.COM

THREE DIFFERENT TECHNOLOGIES. ONE PURPOSE: KOOLIN' THE GANG.

Heat and humidity sap worker productivity. Which is why the Evaporative Series works harder than a sled dog to provide up to 4 hours of consistent cooling relief. The secret? Three different hi-tech cooling technologies: a hyper-evaporative Microfiber fabric, space age polymer cooling crystals, and an advanced PVA material that holds water without feeling heavy. Let's face it, if there was a globally recognized Bandana Towel Technology University, Chill-Its® would have graduated Magna Cool Laude with honors.



SWEET COOLING RELIEF FOR YOUR INNER GREENIE.



MICROFIBER COOLING TOWEL (MF):

Our new chemical-free, non-toxic, cooling powerhouse. Microfiber technology activates instantly when wet, whether that be water or perspiration, and wicks moisture away from the body. Soft and absorbent when dry, and when wet provides sustained cooling for hours on end.



CALL IT COOL. JUST DON'T CALL IT A CHAMOIS.



PVA COOLING TOWEL (CT):

A hyper-evaporative material that's the latest in cooling innovation, this Poly Vinyl Acetal (PVA) material retains water while remaining dry to the touch to provide sweet cooling relief on those sweltering days. Flat Earth-Society approved.



NON-ACTIVATED STATE



ACTIVATED STATE

PLUMPED UP AND READY TO WORK.

THEY PLUMP WHEN YOU CHILL 'EM!



ACRYLIC POLYMER CRYSTALS:

When soaked in cold water, these non-toxic, super-absorbent acrylic polymers expand and absorb just enough water to create a love potion #9 sensation for up to four hours. If sweet cooling sensation lasts more than four hours, please consult a physician. ☺

CHILL-ITS® COOLING:

EVAPORATIVE SERIES

DIFFERENTIATED BY DESIGN

COOLING TECHNOLOGY

Non-toxic, chemical-free material is super evaporative and feels significantly cooler than ambient air when activated.

MICROFIBER CONSTRUCTION

Woven material is lightweight, soft, and absorbent to provide all day comfort.

SUN PROTECTION

UPF 50+ provides protection from the sun's harmful UV rays.



6602MF

COOLING TOWEL COLORS: *Note: all colors not necessarily available in all styles. See specific product for listing.



Blue



Hi-Vis Lime



Orange



Pink



Gray

	6700_{MF}	ORDER MULTIPLE 6
TIE BANDANA W/ MICROFIBER		
<ul style="list-style-type: none"> • Microfiber material is soft and absorbent • Super-evaporative, feels cooler than ambient air • Re-usable, just rewet to reactivate • UPF 50+ for protection against harmful UV rays • Tie closure • 2-sided color 		
ITEM #	SIZE	COLOR
12347	—	Blue

	6705_{MF}	ORDER MULTIPLE 6
HOOK & LOOP BANDANA W/ MICROFIBER		
<ul style="list-style-type: none"> • Microfiber material is soft and absorbent • Super-evaporative, feels cooler than ambient air • Re-usable, just rewet to reactivate • UPF 50+ for protection against harmful UV rays • Breakaway hook and loop closure • 2-sided color 		
ITEM #	SIZE	COLOR
12357	—	Blue

	6710_{MF}	ORDER MULTIPLE 6
TRIANGLE HAT W/ MICROFIBER		
<ul style="list-style-type: none"> • Microfiber material is soft and absorbent • Super-evaporative, feels cooler than ambient air • Re-usable, just rewet to reactivate • UPF 50+ for protection against harmful UV rays • Tie closure • 2-sided color 		
ITEM #	SIZE	COLOR
12367	—	Blue

	6602_{MF}	ORDER MULTIPLE 6			
MICROFIBER COOLING TOWEL					
<ul style="list-style-type: none"> • Microfiber material is soft and absorbent • Super-evaporative, feels cooler than ambient air • Size: 9.8" x 40.9" (25cm x 104cm) • UPF 50+ for protection against harmful UV rays • 2-sided color, gray on reverse for all colors 					
ITEM #	SIZE	COLOR	ITEM #	SIZE	COLOR
12660	—	Blue	12661	—	Orange
12662	—	Pink	12668	—	Gray
12669	—	HV Lime			

	8935_{MF}	ORDER MULTIPLE 6
HI-VIS RANGER HAT W/ MICROFIBER		
<ul style="list-style-type: none"> • Microfiber material lines the inside hat rim • Super-evaporative, feels cooler than ambient air • Easily activated by running microfiber under water • 150D oxford polyester • ANSI-compliant tape with contrasting color 		
ITEM #	SIZE	COLOR
12593	S/M	HV Lime
12595	L/XL	HV Lime

OFFICIAL PRODUCT REVIEW

unscripted • unbiased • unabashed

TESTER: JOSH NELSON

PRODUCT: 6602MF

“As someone who works outdoors (and sweats a lot!), this microfiber cooling towel is a must-have on the job. It cools me off, but isn't too heavy and is easy to clean.”

ONE WORD REVIEW: **MUST-HAVE**

Chill-Its COOLING PRODUCTS

CHILL-ITS® COOLING:

EVAPORATIVE SERIES

DIFFERENTIATED BY DESIGN

COOLING TECHNOLOGY

Using absorbent acrylic polymers, hyper-evaporative PVA, or micro-fiber material - these products activate easily and quickly to provide a cooling sensation.



6705CT ORDER MULTIPLE 6

HOOK & LOOP COOLING BANDANA WITH TOWEL



- Advanced PVA material activates easily and quickly
- Re-usable, just rewet to reactivate
- Super-evaporative cooling process keeps you cool
- Breakaway hook and loop closure
- Rinse before use

ITEM #	SIZE	COLOR	ITEM #	SIZE	COLOR
12571	—	Stars & Stripes	12577	—	Solid Blue
12573	—	Red Western	12572	—	Camo
12574	—	Navy Western	12578	—	Flames
12576	—	HV Lime	12579	—	Skulls

// PATENTED

6710CT ORDER MULTIPLE 6

COOLING TRIANGLE HAT WITH TOWEL



- Advanced PVA material activates easily and quickly
- Re-usable, just rewet to reactivate
- Super-evaporative cooling process keeps you cool
- Tie closure
- Rinse before use

ITEM #	SIZE	COLOR	ITEM #	SIZE	COLOR
12581	—	Stars & Stripes	12587	—	Solid Blue
12583	—	Red Western	12582	—	Camo
12584	—	Navy Western	12588	—	Flames
12586	—	HV Lime	12589	—	Skulls

// PATENTED

6715CT ORDER MULTIPLE 6

COOLING TOWEL HARD HAT PAD



- Advanced PVA material activates easily and quickly
- Hook and loop closures
- Conveniently attaches to hard hat suspension
- Re-usable, just rewet to reactivate
- Rinse before use

ITEM #	SIZE	COLOR
12597	—	Blue

// PATENTED

	6670 _{CT}	ORDER MULTIPLE 6
COOLING TOWEL HARD HAT NECK SHADE		
<ul style="list-style-type: none"> • Advanced PVA material activates easily and quickly • Re-usable, just rewet to reactivate • Super-evaporative cooling process keeps you cool • Hook and loop straps for easy attachment • Rinse before use 		
ITEM #	SIZE	COLOR
12523	—	HV Lime
// PATENTED		

	6717 _{CT}	ORDER MULTIPLE 6
HARD HAT PAD AND NECK SHADE		
<ul style="list-style-type: none"> • Advanced PVA material activates easily and quickly • Hook and loop closures • Protects neck from harmful UV rays • Conveniently attaches to hard hat suspension • Re-usable, just rewet to reactivate • Rinse before use 		
ITEM #	SIZE	COLOR
12596	—	Blue
// PATENTED		



	8935 _{CT}	ORDER MULTIPLE 6
COOLING TOWEL HI-VIS RANGER HAT		
<ul style="list-style-type: none"> • Advanced PVA material lines the inside hat rim • Easily activated by running towel under water • 150D oxford polyester • ANSI-compliant tape with contrasting color • Cooling sensation lasts up to 4 hours • Rinse before use 		
ITEM #	SIZE	COLOR
12590	S/M	HV Lime
12591	L/XL	HV Lime
// PATENTED		

	6602	ORDER MULTIPLE 1
COOLING TOWEL		
<ul style="list-style-type: none"> • Advanced PVA cooling technology • Super-evaporative, feels cooler than ambient air • Activates fast and easy - run under water • Machine washable • Size: 13" x 29.5" (33cm x 75cm) • Rinse before use 		
ITEM #	SIZE	COLOR
12420	—	Blue
12410	—	Blue (50pk)
12439	—	HV Lime
ITEM #	SIZE	COLOR
12441	—	Orange
12442	—	Pink
12438	—	Gray
// PATENTED		

	6603	ORDER MULTIPLE 1
COOLING TOWEL BAND		
<ul style="list-style-type: none"> • Advanced PVA cooling technology • Super-evaporative, feels cooler than ambient air • Activates fast and easy - run under water • Wear as neck wrap by pulling end through slit • Size: 4" x 29.5" (10cm x 75cm) • Rinse before use 		
ITEM #	SIZE	COLOR
12418	—	Blue
// PATENTED		

	6700 _{CT}	ORDER MULTIPLE 6
COOLING BANDANA WITH TOWEL		
<ul style="list-style-type: none"> • Advanced PVA material activates easily and quickly • Re-usable, just rewet to reactivate • Super-evaporative cooling process keeps you cool • Tie closure • Rinse before use 		
ITEM #	SIZE	COLOR
12561	—	Stars & Stripes
12563	—	Red Western
12564	—	Navy Western
12566	—	HV Lime
ITEM #	SIZE	COLOR
12567	—	Solid Blue
12562	—	Camo
12568	—	Flames
12569	—	Skulls
// PATENTED		

	6700	ORDER MULTIPLE 24
COOLING BANDANA		
		
<ul style="list-style-type: none"> • Bandana/headband - tie closure • Soak in cold water 2-5 minutes to activate • Remains cool for up to 4 hours • Re-usable, just rewet to reactivate 		
ITEM # SIZE COLOR	ITEM # SIZE COLOR	
12303 — Stars & Stripes	12306 — Navy Western	
12304 — Camouflage	12307 — Solid Blue	
12305 — Red Western	12341 — Flames	
12301 — HV Lime	12329 — Skulls	

	6705	ORDER MULTIPLE 24
HOOK & LOOP COOLING BANDANA		
		
<ul style="list-style-type: none"> • Hook and loop closure • Soak in cold water 2-5 minutes to activate • Remains cool for up to 4 hours • Re-usable, just rewet to reactivate 		
ITEM # SIZE COLOR	ITEM # SIZE COLOR	
12313 — Stars & Stripes	12317 — Solid Blue	
12314 — Camouflage	12321 — HV Lime	
12315 — Red Western	12311 — Flames	
12316 — Navy Western	12349 — Skulls	

	6710	ORDER MULTIPLE 24
COOLING TRIANGLE HAT		
		
<ul style="list-style-type: none"> • Triangle hat - tie closure • Soak in cold water 2-5 minutes to activate • Remains cool for up to 4 hours • Re-usable, just rewet to reactivate 		
ITEM # SIZE COLOR	ITEM # SIZE COLOR	
12323 — Stars & Stripes	12327 — Solid Blue	
12324 — Camouflage	12331 — HV Lime	
12325 — Red Western	12328 — Flames	
12326 — Navy Western	12359 — Skulls	

	6715	ORDER MULTIPLE 24
COOLING HARD HAT PAD		
		
<ul style="list-style-type: none"> • Lightweight, cooling acrylic polymers • Hook and loop closures • Conveniently attaches to hard hat suspension • Soak in cold water 2-5 minutes to activate • Remains cool for up to 4 hours 		
EM # SIZE COLOR		
12337 — Blue		

	6716	ORDER MULTIPLE 24
COOLING HARD HAT LINER		
		
<ul style="list-style-type: none"> • Lightweight, cooling acrylic polymers • Hook and loop closures • Conveniently attaches to hard hat suspension • Soak in cold water 2-5 minutes to activate • Remains cool for up to 4 hours 		
ITEM # SIZE COLOR		
12338 — Blue		

	6717	ORDER MULTIPLE 24
COOL HARD HAT PAD WITH NECK SHADE		
		
<ul style="list-style-type: none"> • Lightweight, cooling acrylic polymers • Hook and loop closures • Protects neck from harmful UV rays • Conveniently attaches to hard hat suspension • Soak in cold water 2-5 minutes to activate 		
ITEM # SIZE COLOR		
12336 — Blue		

**CHILL-ITS®
COLORS & PATTERNS:**

*Note: all colors not necessarily available in all styles.
See specific product for listing.



Camo



Flames



Red Western



Navy Western



Blue



Hi-Vis Lime



Stars & Stripes

**CHILL-ITS® MULTI-BAND
COLORS & PATTERNS:**

*Note: all colors not necessarily available in all styles.
See specific product for listing.



Stars & Stripes



Red Western



Navy Western



Hi-Vis Lime



Flames



Be Tenacious



Skulls



Navy

		6700_{FR}	ORDER MULTIPLE 6
FR COOLING BANDANA			
FR		NFPA 70E CAT 1	
		ATPV 7.1 CAL/CM²	
<ul style="list-style-type: none"> • Modacrylic cotton blend FR fabric • Fabric meets ASTM F1506 performance requirements • Soak in cold water 2-5 minutes to activate • Bandana/headband - tie closure 			
ITEM #	SIZE	COLOR	
12601	—	Hi-Vis Lime	
12607	—	Solid Blue	

		6705_{FR}	ORDER MULTIPLE 6
HOOK & LOOP FR COOLING BANDANA			
FR		NFPA 70E CAT 1	
		ATPV 7.1 CAL/CM²	
<ul style="list-style-type: none"> • Modacrylic cotton blend FR fabric • Fabric meets ASTM F1506 performance requirements • Soak in cold water 2-5 minutes to activate • Bandana/headband - hook and loop 			
ITEM #	SIZE	COLOR	
12611	—	Hi-Vis Lime	
12617	—	Solid Blue	

		6710_{FR}	ORDER MULTIPLE 6
FR COOLING TRIANGLE HAT			
FR		NFPA 70E CAT 1	
		ATPV 7.1 CAL/CM²	
<ul style="list-style-type: none"> • Modacrylic cotton blend FR fabric • Fabric meets ASTM F1506 performance requirements • Soak in cold water 2-5 minutes to activate • Triangle Hat 			
ITEM #	SIZE	COLOR	
12621	—	Hi-Vis Lime	
12627	—	Solid Blue	

		6717_{FR}	ORDER MULTIPLE 6
FR HARD HAT PAD WITH SHADE			
FR		NFPA 70E CAT 1	
		ATPV 7.1 CAL/CM²	
<ul style="list-style-type: none"> • Protects neck from harmful UV rays • Modacrylic cotton blend FR fabric • Fabric meets ASTM F1506 performance requirements • Soak in cold water 2-5 minutes to activate 			
ITEM #	SIZE	COLOR	
12657	—	Blue	

CHILL-ITS® COOLING:

EVAPORATIVE SERIES

DIFFERENTIATED BY DESIGN



CONSTRUCTION

Lightweight, durable material ensures a comfortable fit all day.

DESIGN

Vest features hi-visibility fabric, YKK zippers, and mesh panels for additional comfort and stretch.

COOLING TECHNOLOGY

Patented dry evaporative cooling technology activates easily with water - no refrigeration, gels, or chemicals required. Capacity to cool up to 15° below ambient air temperatures.

			6685			ORDER MULTIPLE 1		
DRY EVAPORATIVE COOLING VEST								
<ul style="list-style-type: none"> • Provides immediate and long lasting cooling • Up to 3 days of cooling ability • Activate with 13-20oz (400-600ml) water • Lightweight, durable, and machine washable • Easy to use, watertight filling cap 								
ITEM #	SIZE	COLOR	ITEM #	SIZE	COLOR			
12673	M	HV Lime	12676	2XL	HV Lime			
12674	L	HV Lime	12677	3XL	HV Lime			
12675	XL	HV Lime	12678	4XL	HV Lime			

// PATENTED

			6686			ORDER MULTIPLE 1		
DRY EVAPORATIVE COOLING CAP								
<ul style="list-style-type: none"> • Provides immediate and long lasting cooling • Up to 3 days of dry cooling • Activate using 3oz of water • Lightweight, durable, and machine washable • Easy to use, watertight filling cap 								
ITEM #	SIZE	COLOR						
12680	—	HV Lime						

			6665			ORDER MULTIPLE 1		
EVAPORATIVE COOLING VEST								
<ul style="list-style-type: none"> • Activated, super-absorbent material inside • Water-repellent liner • Lightweight, durable, and washable • Soak in cold water 2-5 minutes to activate • Remains cool for up to 4 hours 								
ITEM #	SIZE	COLOR	ITEM #	SIZE	COLOR			
12533	M	HV Lime	12543	M	Gray			
12534	L	HV Lime	12544	L	Gray			
12535	XL	HV Lime	12545	XL	Gray			
12536	2XL	HV Lime	12546	2XL	Gray			
12537	3XL	HV Lime	12547	3XL	Gray			

BEHIND THE TECHNOLOGY

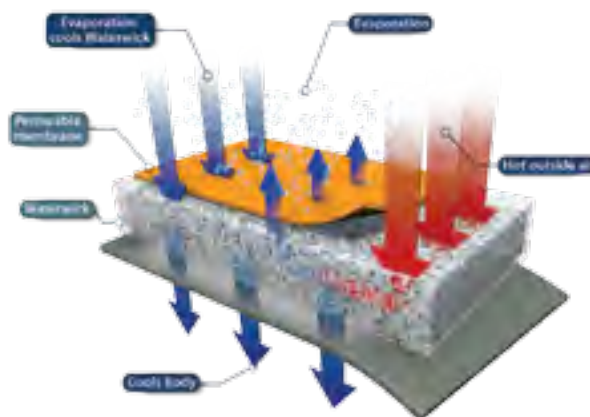

DRY EVAPORATIVE TECHNOLOGY EXPLAINED...

HOW DOES THE 6685 DRY EVAPORATIVE TECHNOLOGY WORK? To activate the vest, open the back cap and fill with 16oz - 20oz (400ML - 600ML) of fresh water. Distribute the water evenly from the back to the front of the vest. The vest's technology gradually releases water through evaporation to keep you cool, dry, and comfortable.

HOW COOL WILL THE VEST GET? Depending on outside temperature and humidity, the vest will cool up to 15 degrees below the ambient temperature. High humidity of 60% - 80% may reduce the cooling ability.

WHAT CAN I EXPECT FROM THE 6685 DRY EVAPORATIVE COOLING VEST? The cooling effect is based on the principles of evaporation. A lower humidity and a high airflow mean a better cooling performance. Please familiarize yourself with the local humidity and environment to better predict performance.

After wearing the vest for a period of time, the body will adapt to the cooler temperature. The vest may no longer feel as cool, however the vest is still cooling. You can compare this with the sensation of swimming in a pool. In the beginning, the water feels cool, after awhile the body will adjust to the temperature — but cooling is still taking place.

HOW MUCH WATER IS NEEDED? Enough water to saturate the membrane on the inside of the vest. Excess water can be drained through the cap, if desired. Depending on size, 16oz - 20oz (400ML - 600ML) of fresh water is needed to activate the vest.

HOW LONG DOES THE COOLING EFFECT LAST? Cooling effect can last up to 3 days.

HOW TIGHT SHOULD THE GARMENT FIT? A close fit will help you feel the cooling effect. We recommend a lightweight T-shirt underneath.

CAN THE GARMENT BE WORN UNDERNEATH OTHER GARMENTS? Yes it can, but the vest needs enough airflow to be able to evaporate the water. For example, a mesh vest will provide enough airflow for the vest to function properly, while a heavy coverall would not.

DO I NEED TO CLEAN THE INSIDE OF THE VEST? No, the membrane on the inside of the vest is treated with an antimicrobial treatment that will prevent bacteria, fungi, and other contaminations. We recommend keeping the cap closed at all times.

CAN I WASH THE PRODUCT? Yes, with the cap closed. See washing instructions on the inside of the vest.



FIND OUT MORE ABOUT THE TECHNOLOGY THAT GOES INTO THE FULL LINE OF ERGODYNE COOLING PRODUCTS AT: WWW.ERGODYNE.COM

CHILL-ITS® COOLING:

ABSORPTIVE SERIES

DIFFERENTIATED BY DESIGN

HIGH-PERFORMANCE FABRIC

Technical fabric moves moisture away from the body for fast evaporation.



ELASTIC

Elastic band components keep absorbent materials next to skin for an effective, secure fit.

TERRY CLOTH

Keeps perspiration out of eyes and away from hands for clearer vision and safer grips.

	6650	ORDER MULTIPLE 1									
HIGH-PERFORMANCE HAT WITH NECK SHADE											
<ul style="list-style-type: none"> • Hi Cool® moisture management performance fabric • Absorbent terry headband • Wide panel neck protection • Adjustable cinch cord for a great fit 											
<table border="1"> <thead> <tr> <th>ITEM #</th> <th>SIZE</th> <th>COLOR</th> </tr> </thead> <tbody> <tr> <td>12520</td> <td>—</td> <td>HV Lime</td> </tr> <tr> <td>12521</td> <td>—</td> <td>HV Orange</td> </tr> </tbody> </table>			ITEM #	SIZE	COLOR	12520	—	HV Lime	12521	—	HV Orange
ITEM #	SIZE	COLOR									
12520	—	HV Lime									
12521	—	HV Orange									

		6615	ORDER MULTIPLE 6																														
HIGH-PERFORMANCE DEW RAG																																	
<ul style="list-style-type: none"> • Hi Cool® moisture management performance fabric • Comfortable to wear under hats, helmets, or alone • Absorbent terry headband • Elastic band for a great fit • Machine washable 																																	
<table border="1"> <thead> <tr> <th>ITEM #</th> <th>SIZE</th> <th>COLOR</th> <th>ITEM #</th> <th>SIZE</th> <th>COLOR</th> </tr> </thead> <tbody> <tr> <td>12476</td> <td>—</td> <td>HV Lime</td> <td>12480</td> <td>—</td> <td>Navy Western</td> </tr> <tr> <td>12477</td> <td>—</td> <td>Stars & Stripes</td> <td>12481</td> <td>—</td> <td>Solid Blue</td> </tr> <tr> <td>12478</td> <td>—</td> <td>Camouflage</td> <td>12485</td> <td>—</td> <td>Flames</td> </tr> <tr> <td>12479</td> <td>—</td> <td>Red Western</td> <td>12519</td> <td>—</td> <td>Skulls</td> </tr> </tbody> </table>				ITEM #	SIZE	COLOR	ITEM #	SIZE	COLOR	12476	—	HV Lime	12480	—	Navy Western	12477	—	Stars & Stripes	12481	—	Solid Blue	12478	—	Camouflage	12485	—	Flames	12479	—	Red Western	12519	—	Skulls
ITEM #	SIZE	COLOR	ITEM #	SIZE	COLOR																												
12476	—	HV Lime	12480	—	Navy Western																												
12477	—	Stars & Stripes	12481	—	Solid Blue																												
12478	—	Camouflage	12485	—	Flames																												
12479	—	Red Western	12519	—	Skulls																												

		6630	ORDER MULTIPLE 6																														
HIGH-PERFORMANCE SKULL CAP																																	
<ul style="list-style-type: none"> • Hi Cool® moisture management performance fabric • Comfortable to wear under hats, helmets, or alone • Wide, absorbent terrycloth band • One size fits most • Machine washable 																																	
<table border="1"> <thead> <tr> <th>ITEM #</th> <th>SIZE</th> <th>COLOR</th> <th>ITEM #</th> <th>SIZE</th> <th>COLOR</th> </tr> </thead> <tbody> <tr> <td>12505</td> <td>—</td> <td>HV Lime</td> <td>12509</td> <td>—</td> <td>Navy Western</td> </tr> <tr> <td>12506</td> <td>—</td> <td>Stars & Stripes</td> <td>12510</td> <td>—</td> <td>Solid Blue</td> </tr> <tr> <td>12507</td> <td>—</td> <td>Camouflage</td> <td>12514</td> <td>—</td> <td>Flames</td> </tr> <tr> <td>12508</td> <td>—</td> <td>Red Western</td> <td>12529</td> <td>—</td> <td>Skulls</td> </tr> </tbody> </table>				ITEM #	SIZE	COLOR	ITEM #	SIZE	COLOR	12505	—	HV Lime	12509	—	Navy Western	12506	—	Stars & Stripes	12510	—	Solid Blue	12507	—	Camouflage	12514	—	Flames	12508	—	Red Western	12529	—	Skulls
ITEM #	SIZE	COLOR	ITEM #	SIZE	COLOR																												
12505	—	HV Lime	12509	—	Navy Western																												
12506	—	Stars & Stripes	12510	—	Solid Blue																												
12507	—	Camouflage	12514	—	Flames																												
12508	—	Red Western	12529	—	Skulls																												

		6605	ORDER MULTIPLE 6																														
HIGH-PERFORMANCE HEADBAND																																	
<ul style="list-style-type: none"> • Hi Cool® moisture management performance fabric • Absorbent terry headband • Elasticized back for a great fit • One size fits most • Machine washable 																																	
<table border="1"> <thead> <tr> <th>ITEM #</th> <th>SIZE</th> <th>COLOR</th> <th>ITEM #</th> <th>SIZE</th> <th>COLOR</th> </tr> </thead> <tbody> <tr> <td>12421</td> <td>—</td> <td>Stars & Stripes</td> <td>12425</td> <td>—</td> <td>Solid Blue</td> </tr> <tr> <td>12422</td> <td>—</td> <td>Camouflage</td> <td>12429</td> <td>—</td> <td>Flames</td> </tr> <tr> <td>12423</td> <td>—</td> <td>Red Western</td> <td>12431</td> <td>—</td> <td>HV Lime</td> </tr> <tr> <td>12424</td> <td>—</td> <td>Navy Western</td> <td>12489</td> <td>—</td> <td>Skulls</td> </tr> </tbody> </table>				ITEM #	SIZE	COLOR	ITEM #	SIZE	COLOR	12421	—	Stars & Stripes	12425	—	Solid Blue	12422	—	Camouflage	12429	—	Flames	12423	—	Red Western	12431	—	HV Lime	12424	—	Navy Western	12489	—	Skulls
ITEM #	SIZE	COLOR	ITEM #	SIZE	COLOR																												
12421	—	Stars & Stripes	12425	—	Solid Blue																												
12422	—	Camouflage	12429	—	Flames																												
12423	—	Red Western	12431	—	HV Lime																												
12424	—	Navy Western	12489	—	Skulls																												

	6660	ORDER MULTIPLE 6
--	-------------	----------------------------

HARD HAT BRIM WITH SHADE

- 100% polyester fabric
- Universal design - elastic inner rim to fit most hard hats
- Blocks the sun's rays keeping workers comfortable
- Longer length
- Hook and loop straps for hard hat connection

ITEM #	SIZE	COLOR
12640	—	HV Lime
12641	—	HV Orange

// PATENTED

	6500/6550	ORDER MULTIPLE 6
--	------------------	----------------------------

TERRY SWEATBAND

- Thick, absorbent cotton terry
- Elastic maintains snug fit

6500: WRIST SWEATBAND			6550: HEAD SWEATBAND		
ITEM #	SIZE	COLOR	ITEM #	SIZE	COLOR
12402	—	Black	12450	—	White
			12452	—	Black

	6609	ORDER MULTIPLE 24
--	-------------	-----------------------------

TERRY SWEATBAND

- Absorbent terry headband
- Fits most hard hat suspension systems
- Machine washable
- 100% cotton

ITEM #	SIZE	COLOR
12440	—	Gray (24pk)
12443	—	Gray (100pk)

MAKE IT CUSTOM!



CUSTOM MULTI-BANDS



Whether you are selling Multi-Bands or just handing them out like candy at a parade, adding a custom company logo or special pattern can increase brand awareness and convey whatever message your company, event, or promotion wants to deliver.

It's as easy as picking a particular print from our library or providing one of your own.* Quantities start at just six pieces and the process takes just one to three weeks to complete.

Questions about our customer logging program? Call Ergodyne Customer Support today to get answers and make your mark.

* Additional charges may apply for custom artwork.

	6485	ORDER MULTIPLE 1
--	-------------	----------------------------

MULTI-BAND

- Multiple style and usage configurations
- Moisture management performance fabric dries fast
- Anti-stink treatment helps workers remain unscented
- Stretchable, comfortable, and seam-free
- Blocks wind, sun, and dust

ITEM #	SIZE	COLOR	ITEM #	SIZE	COLOR
42103	—	Stars & Stripes	42111	—	Flames
42105	—	Red Western	42112	—	Skulls
42106	—	Navy Western	42119	—	Be Tenacious
42108	—	HV Lime			

	6486	ORDER MULTIPLE 1
--	-------------	----------------------------

FR MULTI-BAND

FR

🔥

NFPA 70E CAT 1

ATPV 4.2CAL/CM²

- Inherently FR Nomex® knit fabric
- Meets requirements of ASTM F1506
- Classified CAT 1 according to NFPA 70E
- Anti-stink treatment helps workers remain unscented
- Multi-climate usage
- Stretchable, comfortable, and seam-free

ITEM #	SIZE	COLOR
42201	—	Navy

CHILL-ITS® COOLING:

PHASE CHANGE SERIES

DIFFERENTIATED BY DESIGN

HI-VISIBILITY

Optional models with ANSI-certified fabric and retro reflective tape offer conspicuity AND cool comfort.



6215HV

FLAME RESISTANT

Optional models with inherent modacrylic fabric meets ASTM F1506 performance requirements; classified CAT 1 per NFPA 70E.

PHASE CHANGE MATERIAL

Non-toxic, non-carcinogenic dielectric substance maintains a constant 64° F // 18° C temperature.

ADJUSTABLE FIT

Elastic straps and hook and loop closures let workers adjust the fit for optimal comfort.

			<h1>6215</h1>			<small>ORDER MULTIPLE</small> 1		
PREMIUM PHASE CHANGE VEST								
			NFPA 70E CAT 1			ATPV 7.1 CAL/CM²		
<ul style="list-style-type: none"> • Maintains constant 64°F / 18°C • Cooling lifecycle lasts up to four hours • Modacrylic cotton blend FR fabric • Extended vest surface area enhances cooling power • Fabric meets ASTM F1506 per NFPA 70E (CAT 1) 								
VEST+PACKS			VEST ONLY					
ITEM #	SIZE	COLOR	ITEM #	SIZE	COLOR			
12200	S/M	Khaki	12203	S/M	Khaki			
12210	L/XL	Khaki	12204	L/XL	Khaki			

			<h1>6215_{HV}</h1>			<small>ORDER MULTIPLE</small> 1		
HI-VIS PREMIUM PHASE CHANGE VEST								
			NFPA 70E CAT 1			ATPV 7.1 CAL/CM²		
<ul style="list-style-type: none"> • Maintains constant 64°F / 18°C • Cooling lifecycle lasts up to four hours • Modacrylic cotton blend FR fabric • Extended vest surface area enhances cooling power • Fabric meets ASTM F1506 per NFPA 70E (CAT 1) 								
VEST+PACKS			VEST ONLY					
ITEM #	SIZE	COLOR	ITEM #	SIZE	COLOR			
12220	S/M	HV Orange	12205	S/M	HV Orange			
12221	L/XL	HV Orange	12206	L/XL	HV Orange			

			<h1>6230</h1>			<small>ORDER MULTIPLE</small> 1		
STANDARD PHASE CHANGE VEST								
<ul style="list-style-type: none"> • Maintains constant 64°F / 18°C • Cooling lifecycle lasts up to four hours • Comfortable cotton construction • Extended vest surface area enhances cooling power • Non-toxic, non carcinogenic, dielectric substance 								
VEST+PACKS			VEST ONLY					
ITEM #	SIZE	COLOR	ITEM #	SIZE	COLOR			
12000	S/M	Khaki	12003	S/M	Khaki			
12010	L/XL	Khaki	12004	L/XL	Khaki			

PHASE CHANGE TECHNOLOGY



CHARGE PACK

ACTIVATED CHARGE PACK

WHAT IS THIS THING, ANYWAY?

UP CLOSE & PERSONAL WITH THE PHASE CHANGE VEST:

- KEEPS WORKERS COOL + PRODUCTIVE.
- 64°F // 18°C ONLY. NO MORE. NO LESS. LASTS FOR UP TO 4 HOURS REGARDLESS OF OUTSIDE TEMP.
- FR PROTECTION ON PREMIUM MODELS.
- UNLIKE EVAPORATIVE PRODUCTS, THERE IS NO AIRFLOW REQUIRED FOR COOLING!
- IDEAL FOR EXTREME HEAT APPLICATIONS: FOUNDRIES, GLASS MANUFACTURING, PAPER AND PULP.



		6240	ORDER MULTIPLE 1									
VEST EXTENDERS												
<ul style="list-style-type: none"> • 100% elastic hook and loop extenders • .5" (9cm) elastic width for more stretch 												
<table border="1"> <thead> <tr> <th>ITEM #</th> <th>SIZE</th> <th>COLOR</th> </tr> </thead> <tbody> <tr> <td>12209</td> <td>—</td> <td>HV Orange</td> </tr> <tr> <td>12208</td> <td>—</td> <td>Black</td> </tr> </tbody> </table>				ITEM #	SIZE	COLOR	12209	—	HV Orange	12208	—	Black
ITEM #	SIZE	COLOR										
12209	—	HV Orange										
12208	—	Black										

		6220	ORDER MULTIPLE 1									
REPLACEMENT CHARGE PACKS												
<ul style="list-style-type: none"> • Maintains constant 64°F / 18°C • Cooling lifecycle lasts up to four hours • Honeycomb design for increased flexibility 												
<table border="1"> <thead> <tr> <th>ITEM #</th> <th>SIZE</th> <th>COLOR</th> </tr> </thead> <tbody> <tr> <td>12201</td> <td>S/M</td> <td>Clear</td> </tr> <tr> <td>12202</td> <td>L/XL</td> <td>Clear</td> </tr> </tbody> </table>				ITEM #	SIZE	COLOR	12201	S/M	Clear	12202	L/XL	Clear
ITEM #	SIZE	COLOR										
12201	S/M	Clear										
12202	L/XL	Clear										
// PATENTED												

CHILL-ITS® COOLING:

HYDRATION SERIES

DIFFERENTIATED BY DESIGN

600D RIP STOP POLYESTER SHELL

Durable and water-resistant 600D rip stop polyester shell protects hydration pack from wear and tear.

BREAKAWAY SHOULDER STRAPS

Breakaway shoulder straps for added safety.



ANTI-MICROBIAL DUAL CAP BLADDER

Featuring smaller (60mm) cap nestled into larger (80mm) cap for easy water and ice filling.



TPE BLADDER

TPE eliminates plastic odor and taste and stays supple to withstand daily wear and tear.

LARGE COVERED CAP

Dual cap bladder for easy refilling and ice cube loading. Zip-up cover keeps out debris and contaminants.

OPTIONAL PUMP

Get hydrated faster! Shower yourself with cooling goodness.

5158

5157

ORDER MULTIPLE
1

PREMIUM CARGO HYDRATION PACK



- Durable 600D water-resistant rip stop polyester
- Vented straps and back for maximum breathability
- 8mm EVA foam padding on shoulder straps
- 5 zippered compartments, D-rings, and webbing
- 100% anti-microbial bite valve with cover to protect

ITEM #	SIZE	COLOR
13163	3L	Black
13164	3L	HV Lime
13059	3L	Bladder



5156

ORDER MULTIPLE
1

PREMIUM LOW PROFILE HYDRATION PACK



- Durable 600D water-resistant rip stop polyester
- Vented straps and back for maximum breathability
- 8mm EVA foam padding on shoulder straps
- Zippered compartment, D-rings, and webbing
- Insulated pack and tube keeps water cool

ITEM #	SIZE	COLOR
13161	3L	Black
13162	3L	HV Lime
13059	3L	Bladder



5155

ORDER MULTIPLE
1

LOW PROFILE HYDRATION PACK





- Durable 600D water-resistant rip stop polyester
- Insulated pack and tube keeps water cool
- 100% anti-microbial bite valve with cover
- Breakaway shoulder straps for additional safety
- Hi-vis options for added visibility

ITEM #	SIZE	COLOR	ITEM #	SIZE	COLOR
13155	2L	Black	13156	2L	HV Lime
13057	2L	Bladder	13157	2L	HV Orange

5158

ORDER MULTIPLE
1

HYDRATION PACK PRESSURE PUMP



- FDA approved food grade silicone body
- Elastic strap for secure fit
- Valve cover keeps debris off bulb tip
- Fits with all Chill-Its® Hydration Packs

ITEM #	SIZE	COLOR
13158	—	Blue

5159

ORDER MULTIPLE
1

HYDRATION PACK BLADDER CLEANING KIT

NEW FOR
'17



- Compatible with any Chill-Its® bladder
- Drying rack to air dry bladder
- Bladder cleaning brush
- Delivery system cleaning brush

ITEM #	SIZE	COLOR
13159	—	N/A

5151

ORDER MULTIPLE
1

PLASTIC WIDE MOUTH WATER BOTTLE



- Impact-resistant tritan copolyester plastic
- Odor resistant, durability to high heat and humidity
- Wide mouth to easily fit ice cubes
- BPA free, Dishwasher safe
- Compatible with Arsenal® 5564

ITEM #	SIZE	COLOR
13151	1L	Orange
13152	1L	Gray
13153	1L	Lime



SHAX® WORK SHELTERS

Every now and then the elements range from inclement to apocalyptic. So if you find yourself caught short out in the wild, we give you SHAX® Work Shelters. These beauties provide a safe haven when the sun bakes, skies pour, and the wind howls. UV-blocking, PU-coated, and equipped with a roller bag, these mobile and easy to set up shelters are your go-to for relief from the wrath of the Great Outdoors.

WORK SHELTERS // POP-UP SERIES



6000 Heavy-Duty Commercial Tent



6010 Lightweight Tent

WORK SHELTERS // UMBRELLA SERIES



6100 Lightweight Umbrella

WORK SHELTERS // ACCESSORIES



6094 Tent Weight Bags



6098 Side Panel



6095 Misting System



6193 Umbrella Trailer Hitch Mount



6190 Umbrella Stand



MARY POPPINS-APPROVED.

SHAX
PORTABLE WORK
SHELTERS

SHAX® WORK SHELTERS:

POP-UP SERIES

DIFFERENTIATED BY DESIGN

CANOPY

UV coating to block sun's rays and a PU coating to protect from the harshest elements. Double vented canopy for ventilation and easy airflow.

REFLECTIVE AND REINFORCED

Reflective accents make for great visibility during low light hours and reinforced corners provide additional durability at pressure points.

10x10 FOOTPRINT

10x10 footprint, versatile, and durable shelter that provides long lasting relief from sun, wind, and rain.

ADJUSTABLE MECHANICS

Easy adjustable features for quick, convenient height adjustment.



6000

What is CPAI-84??

CPAI-84 is a flammability specification, written by Industrial Fabrics Association International (say that ten times fast!) as a voluntary industry specification. CPAI-84 (Canvas Products Association International) standard is widely used in the industry and has been adopted by states like California and New Jersey. It provides test methods for evaluating flame resistance of fabric and other pliable materials in camping tentage. It also provides performance criteria and certification guidelines for suppliers (that's us!) and labeling requirements that identify a tent as being constructed of flame resistant material and caution against action detrimental to the flame-retardant finishes.



6000

ORDER MULTIPLE
1

HEAVY-DUTY COMMERCIAL TENT



- 10'x10' area, ABS sliders for peak height of 14'
- Poly canopy w/ PU & UV treatments and vented top
- Powder-coated steel frame
- Heavy-duty ground stakes and ropes included
- Wheeled bag for storage/transport, 45lbs (20.4kg)

ITEM #	SIZE	COLOR	DESCRIPTION
12900	10' x 10'	HV Lime	Heavy-Duty Tent
12998	—	HV Lime	Optional Side Panel
12901	10' x 10'	HV Lime	Replacement Canopy
12902	—	Black	Replacement Bag

		6010	ORDER MULTIPLE 1
LIGHTWEIGHT TENT			
<ul style="list-style-type: none"> • 10'x10' area, pull pins for peak height of 14' • Poly top with PU coating, meets CPAI-84 code • Reinforced corners • Hammer tone steel frame • Wheeled bag for storage/transport, 35lbs (15.8kg) 			
ITEM #	SIZE	COLOR	DESCRIPTION
12910	10' x 10'	HV Lime	Lightweight Tent
12998	—	HV Lime	Optional Side Panel
12911	10' x 10'	HV Lime	Replacement Canopy

		6094	ORDER MULTIPLE 1
TENT WEIGHT BAGS			
<ul style="list-style-type: none"> • Polyester bags with water-resistant PU backing • Easy-to-carry poly handle, 40 lbs capacity • Funnel design, offering a wide opening • Hook and loop for a secure fit around tent leg • Works with 6000, 6010 and 6190 models 			
ITEM #	SIZE	COLOR	
12994	2/pk	Black	

		6095	ORDER MULTIPLE 1
SHAX® MISTING SYSTEM			
<ul style="list-style-type: none"> • Heavy-duty plastic, 2 gal. tank with pressure pump • 25' hose and 8 nozzles for multiple install options • Each set of pumps provides up to 20 min. of misting (depends upon water volume and pressure) • Continuous misting with (included) hose connection • Hook-and-loop straps included for easy tethering 			
ITEM #	SIZE	COLOR	
12065	—	Orange/Black	

		6100	ORDER MULTIPLE 1
LIGHTWEIGHT INDUSTRIAL UMBRELLA			
<ul style="list-style-type: none"> • Size: 84" diameter, peak height of 92" • Poly canopy w/ PU & UV treatments and vented top • Meets CPAI-84 flame resistance code • Powder-coated steel pole and ribs, tilt mechanism • Includes oversized storage bag and ground spike 			
ITEM #	SIZE	COLOR	
12967	84"	HV Lime	

		6193	ORDER MULTIPLE 1
UMBRELLA TRAILER HITCH MOUNT			
<ul style="list-style-type: none"> • Fits standard 2" hitch receivers • Holds SHAX® 6100 Umbrella (sold separately) • Thumbscrew holds pole in place • Powder-coated finish on pole 			
ITEM #	SIZE	COLOR	
12993	—	Black	

		6190	ORDER MULTIPLE 1
UMBRELLA STAND			
<ul style="list-style-type: none"> • Powder-coated steel construction • Hinged legs fold making stand easy to use and store • Place 6100 umbrella in top for stability 			
ITEM #	SIZE	COLOR	
12990	—	Black	



N-FERNO®

WARMING PRODUCTS

FEAR NO FROST.



N-FERNO® WARMING PRODUCTS

Since our ancestors decided to forego their furry coats, live indoors, and walk upright, man has been locked in a pitiless battle with Mother Nature. No holds barred, take no prisoners. N-Ferno® Warming Products have leveled the playing field and put Mother Nature (and her little toadie Jack Frost) on the ropes. And are we letting them back up? There's a cold chance in hell.

WARMING PRODUCTS // HEATED CLOTHING & ACC. SERIES



6490 Heated Jacket



6490B Replacement Battery



6490W Replacement Wall Charger

WARMING PRODUCTS // THERMAL LINER SERIES



6873 3-Layer
w/ FR Modacrylic Shell



6863 3-Layer Liner
w/ Nylon Shell



6867 3-Layer Liner
w/ Nylon Shell



6950 3-Layer Liner
w/ Sherpa



6892 3-Layer FR Liner



6860 2-Layer
w/ FR Modacrylic Shell



6862 2-Layer
w/ FR Modacrylic Shell



6850 2-Layer Liner
w/ Cotton Shell

WARMING PRODUCTS // THERMAL LINER SERIES



6970 Balaclava w/ Hot Rox



6825FR Nomex Balaclava



6828FR Modacrylic Balaclava



6823/6823RT Wind-Proof
Hinged Balaclava

WARMING PRODUCTS // THERMAL BALACLAVA SERIES



6816 Reversible Knit Cap



6819BT Be Tenacious Knit Cap



6820 FR Knit Cap



6802 Classic Trapper™ Hat

WARMING PRODUCTS // THERMAL HAT & CAP SERIES



WARMING PRODUCTS
// THERMAL CLOTHING
SERIES



6465 Thermal / Jacket



6470 Thermal / Bib



6480 Thermal / Ripped Fit



6435 Thermal / Ripped Fit / LS



6952 3-Layer Liner w/ Sherpa



6852 2-Layer Liner w/ Cotton Shell



6885 2-Way 2-Layer FR Liner



6840 2-Layer Fleece Liner - Econo



6880 2-Layer FR Modacrylic Liner



6842 2-Layer Fleece Liner



6882 2-Layer FR Modacrylic Liner



6870 2-Layer Mouth Pc.



6890 3-Layer FR Liner



6872 2-Layer FR Modacrylic Mouth Pc.



6824 Wool Blend Balaclava



6827 2-Pc. Fleece/Neoprene Balaclava



6826 2-Pc. Fleece Balaclava



6822 Balaclava w/ Spandex Top



6821 Fleece Balaclava



6810 Half Stretch Cap



6815 Full Stretch Cap

WARMING PRODUCTS
// ACCESSORIES



6990/6992 Hand & Toe Warming Packs



6995 Foot Warming Packs

N-FERNO® WARMING PRODUCTS:

HEATED CLOTHING & ACC. SERIES

DIFFERENTIATED BY DESIGN

WATER- AND WIND-RESISTANT

Water- and wind-resistant outer shell provides protection from the harshest elements.

TWO HEAT ZONES

Two heat zones distribute heat to the core body regions: chest and back.

THREE HEAT SETTINGS

High, medium, and low heat settings provide customizable warmth.

YKK ZIPPERS

Heavy-duty zippers from the top zipper makers in the world.



6490

7.4V LITHIUM ION BATTERY

7.4V Lithium Ion Battery provides up to 9 hours of continuous heat on low setting, 5 hours on medium setting, and 3 hours on high setting.



6490

ORDER MULTIPLE 1

HEATED JACKET WITH REMOVABLE SLEEVES

- 2 heat zones: front (chest) and back
- 3 heat settings: high, medium, and low
- Preheat mode option for increased warm-up time
- Up to 9 hours of continuous heat
- Battery: 7.4V, 5200 mAh lithium ion battery



6490: HEATED JACKET KIT

ITEM #	SIZE	COLOR
41403	M	Black
41404	L	Black
41405	XL	Black
41406	2XL	Black
41407	3XL	Black

* Includes Heated Jacket, 7.4 Lithium Ion Battery, and Wall Charger

6490J: JACKET REPLACEMENT

ITEM #	SIZE	COLOR
41303	M	Black
41304	L	Black
41305	XL	Black
41306	2XL	Black
41307	3XL	Black

N-FERNO® HEATED CLOTHING EXPLAINED

We developed the 6490 Heated Jacket – aka, the portable furnace – specifically for those battling Hoth-like weather conditions. Uniquely designed to obviate the traditional 3-layer system, our 6490 Heated Jacket uses the power of a light-weight Lithium Ion battery to create heat where it’s needed most – the body’s core. Two heat zones on the chest and back provide three levels of customizable heat for up to nine hours at the touch of a button. Its outer shell is constructed from a water- and wind-resistant fabric to trap heat inside and make sure Mother Nature minds her own business. Multiple pockets provide sufficient storage. This comfy coat is ideal for anyone working in construction, warehousing, distribution, or outdoors needing supercharged warmth without additional bulk.

APPLICATIONS:
 Road Construction
 Heavy Construction
 Building Construction
 Iron/Steel Work
 Oil/Gas Refining
 Drilling/Mining
 Freight/Baggage
 Warehousing/Distribution
 Landscaping/Grounds



TWO HEAT ZONES

Two heat zones distribute heat to the core body regions: chest and back.

REPLACEMENT PARTS & ACCESSORIES:

		6490_B	ORDER MULTIPLE 1
REPLACEMENT BATTERY			
			
<ul style="list-style-type: none"> • Rechargeable lithium ion battery: 7.4V, 5200 mAh 			
ITEM #	SIZE	COLOR	
41501	—	Black	

		6490_W	ORDER MULTIPLE 1
REPLACEMENT WALL CHARGER			
			
<ul style="list-style-type: none"> • Compatible with 7.4V lithium ion battery 			
ITEM #	SIZE	COLOR	
41502	—	Black	

N-FERNO® WARMING PRODUCTS:

THERMAL SERIES

DIFFERENTIATED BY DESIGN



WATER AND WIND RESISTANT

Tough outer shell with DWR finish and PU coating to keep the body warm and dry.

BUILT FOR WORK

Raglan sleeves, flat seams, and long tail cut deliver comfort and toughness required on any jobsite.

REFLECTIVE ACCENTS

Retro-reflective details to help keep you safe and seen.

ANTI-ODOR

Anti-odor helps workers remain un-scented.

YKK ZIPPERS

Heavy-duty zippers from the top zipper makers in the world.

STRETCH FABRIC

Stretch fabric with brushed interior for added warmth and comfort.

ARMORTEX™ REINFORCEMENT

Located on high-wear areas and made of a Kevlar® that is tear-resistant, rub-proof, and heat-friction resistant.

6465

ORDER
MULTIPLE
1

OUTER LAYER/THERMAL/JACKET

- Rugged 300D poly shell w/ PU & UV treatments
- Soft, warm fleece lining
- Armortex™ reinforcement zones in heavy wear areas
- Storm flap front
- 5 pockets including back document and front cell

ITEM #	SIZE	COLOR	ITEM #	SIZE	COLOR
41102	S	Black	41105	XL	Black
41103	M	Black	41106	2XL	Black
41104	L	Black	41107	3XL	Black

6435

ORDER
MULTIPLE
1

BASE LAYER/THERMAL/RIPPED FIT CREW T

- Stretch fabric, brushed interior for warmth and comfort
- Anti-odor helps workers remain unscented
- Moisture wicking treatments keep workers dry
- Raglan sleeves, flat seams, and long tail cut
- Thumb loops to sleeves in place and wind out

ITEM #	SIZE	COLOR	ITEM #	SIZE	COLOR
40203	M	Black	40206	2XL	Black
40204	L	Black	40207	3XL	Black
40205	XL	Black			

N-FERNO® THERMAL BASE LAYERS:

REDESIGNED WITH THE WORKER IN MIND.

Our newly redesigned base layers are built to lock in warmth; ideal for wearing daily in your quest to make even the harshest environments feel like Gilligan's Island.

New stretch fabric has soft brushed interior for next-to-skin comfort that offers next-level warmth.

The smooth jersey exterior ensures layering up without bunching, while the self-fabric crew neck and flat lock seams offer soft comfort against skin. The design features venting in all the right places to aid optimal core temperature maintenance. Raglan sleeves allow for full mobility and we've lengthened the back of the shirt to thwart an embarrassing crack attack. Last (but not least), new thumbholes prevent the dreaded creeping sleeve.

Innovative moisture wicking management transports perspiration away from the skin, keeping you dry even when working hard. Sweat can stink, but an antimicrobial treatment provides odor control for even longer usage.

6470

ORDER
MULTIPLE
1

OUTER LAYER/THERMAL/BIB

- 500D nylon shell provides element protection
- Armortex™ reinforcement zones in heavy wear areas
- Several pockets including hip and chest
- Removable PE foam knee/shin pads
- "Be Tenacious" non-slip, adjustable elastic straps

ITEM #	SIZE	COLOR	ITEM #	SIZE	COLOR
41203	M	Black	41206	2XL	Black
41204	L	Black	41207	3XL	Black
41205	XL	Black			

6480

ORDER
MULTIPLE
1

BASE LAYER/THERMAL/RIPPED FIT

- Stretch fabric, brushed interior for warmth and comfort
- Anti-odor helps workers remain unscented
- Moisture wicking treatments keep workers dry
- Flat seams and tagless waistband

ITEM #	SIZE	COLOR	ITEM #	SIZE	COLOR
40803	M	Black	40806	2XL	Black
40804	L	Black	40807	3XL	Black
40805	XL	Black			

N-FERNO® WARMING PRODUCTS:

THERMAL LINER SERIES

DIFFERENTIATED BY DESIGN

HOOK AND LOOPS

Updated hook and loop configuration to allow for easier installation and secure into a hard hat suspension for ultimate warmth during those cold fall and winter days.

REFLECTIVE DETAIL

Reflective accent for visibility when in low light conditions.

WARMING PACK POCKETS

For extra warmth, place a warming pack into the liner pocket and enjoy hours of toasty relief.

LAYERING DETAILS

Layering systems allow you to choose the product that is right for your climate needs. The more layers, the more warmth.

FLAME RESISTANT AND NON-FLAME RESISTANT OPTIONS

Depending on your needs, stay toasty warm and flame free in FR liners - you've got options!



6885



FIND OUT MORE ABOUT THE TECHNOLOGY THAT GOES INTO THE FULL LINE OF ERGODYNE WARMING PRODUCTS AT: WWW.ERGODYNE.COM

	6877	ORDER MULTIPLE 12
3-LAYER LINER W/FR MODACRYLIC COTTON SHELL		
		6877
<ul style="list-style-type: none"> • Shell: FR modacrylic blend • Mid-Layer: foam • Lining: 100% polyester fleece • Warming pack pockets / hook and loop straps 		
6877: SHOULDER LENGTH		
ITEM #	SIZE	COLOR
16877	—	Black

	6863/6867	ORDER MULTIPLE 12
3-LAYER LINER W/NYLON SHELL		
		6863 6867
<ul style="list-style-type: none"> • Shell: 100% quilted nylon • Mid-Layer: foam • Lining: 100% polyester fleece • Warming pack pockets / hook and loop straps 		
6863: REGULAR LENGTH		6867: SHOULDER LENGTH
ITEM #	SIZE	COLOR
16863	—	Black
ITEM #	SIZE	COLOR
16867	—	Black

	6950/6952	ORDER MULTIPLE 12
3-LAYER FLEECE LINER W/SHERPA		
		6950 6952
<ul style="list-style-type: none"> • Shell: 100% quilted nylon • Mid-Layer: foam • Lining: 100% polyester sherpa • Warming pack pockets / hook and loop straps 		
6950: REGULAR LENGTH		6952: SHOULDER LENGTH
ITEM #	SIZE	COLOR
16950	—	Black
ITEM #	SIZE	COLOR
16952	—	Black

	6885	ORDER MULTIPLE 6
2-WAY - 2-LAYER FR LINER		
	NFPA 70E CAT 2 ATPV 17 CAL/CM ²	
		6885
<ul style="list-style-type: none"> • Top: FR modacrylic twill with FR modacrylic fleece • Lower: double layer FR modacrylic rib knit • Nomex® metal zipper • Warming pack pockets / hook and loop straps • Meets ASTM F1506; classified to NFPA 70E (CAT 2) 		
ITEM #	SIZE	COLOR
16885	—	Black

	6880/6882	ORDER MULTIPLE 6
2-LAYER FR MODACRYLIC LINER		
	NFPA 70E CAT 2 ATPV 20 CAL/CM ²	
		6880 6882
<ul style="list-style-type: none"> • Shell: FR modacrylic blend • Lining: FR modacrylic blend fleece • Warming pack pockets / hook and loop straps • Meets ASTM F1506; classified to NFPA 70E (CAT 2) 		
6880: REGULAR LENGTH		6882: SHOULDER LENGTH
ITEM #	SIZE	COLOR
16880	—	Black
ITEM #	SIZE	COLOR
16882	—	Black

	6890/6892	ORDER MULTIPLE 6
3-LAYER FR MODACRYLIC LINER		
	NFPA 70E CAT 3 ATPV 27 CAL/CM ²	
		6890 6892
<ul style="list-style-type: none"> • Shell: FR modacrylic cotton blend twill • Mid-Layer: 3M™ FR Thinsulate™ • Lining: FR modacrylic cotton blend fleece • Warming pack pockets / hook and loop straps • Meets ASTM F1506; classified to NFPA (CAT 3) 		
6890: REGULAR LENGTH		6892: SHOULDER LENGTH
ITEM #	SIZE	COLOR
16890	—	Black
ITEM #	SIZE	COLOR
16892	—	Black

	6860/6862	ORDER MULTIPLE 12
2-LAYER LINER W/ FR MODACRYLIC COTTON SHELL		
6860		6862
<ul style="list-style-type: none"> • Shell: FR modacrylic blend • Lining: 100% polyester fleece • Warming pack pockets / hook and loop straps 		
6860: REGULAR LENGTH		6862: SHOULDER LENGTH
ITEM #	SIZE	COLOR
16860	—	Black
ITEM #	SIZE	COLOR
16862	—	Black

	6850/6852	ORDER MULTIPLE 12
2-LAYER LINER W/COTTON SHELL		
6850		6852
<ul style="list-style-type: none"> • Shell: 100% cotton twill • Lining: 100% polyester fleece • Warming pack pockets / hook and loop straps 		
6850: REGULAR LENGTH		6852: SHOULDER LENGTH
ITEM #	SIZE	COLOR
16850	—	Black
ITEM #	SIZE	COLOR
16852	—	Black

	6840/6842	ORDER MULTIPLE 12
2-LAYER FLEECE LINER - ECONO		
6840		6842
<ul style="list-style-type: none"> • Shell: 100% polyester with PU coating • Lining: 100% polyester fleece • Hook and loop straps 		
6840: REGULAR LENGTH		6842: SHOULDER LENGTH
ITEM #	SIZE	COLOR
16840	—	Black
ITEM #	SIZE	COLOR
16842	—	Black

	6870	ORDER MULTIPLE 12
2-LAYER MOUTH PIECE		
<ul style="list-style-type: none"> • 2-Layer, adjustable mouthpiece-cotton/fleece • Shell: 100% cotton twill • Lining: 100% polyester fleece • Hook and loop closure • Attach to winter liner for face coverage 		
ITEM #	SIZE	COLOR
16870	—	Black

	6872	ORDER MULTIPLE 6
2-LAYER FR MODACRYLIC MOUTHPIECE		
<ul style="list-style-type: none"> • 2-Layer, adjustable mouthpiece • Shell: FR modacrylic cotton blend twill • Lining: FR modacrylic cotton blend fleece • Meets ASTM F1506; classified to NFPA 70E (CAT 2) • Attach to a winter liner for face coverage 		
ITEM #	SIZE	COLOR
16872	—	Black

	6842	ORDER MULTIPLE 12
2-LAYER FLEECE LINER - HI-VIS LIME		
<ul style="list-style-type: none"> • Hi-Vis lime nylon with black fleece • Shell: 100% 150D oxford polyester • Lining: 100% polyester fleece • Warming pack pockets for added warmth • Hook & loop chin strap and hard hat attachments 		
ITEM #	SIZE	COLOR
16841	—	HV Lime

N-FERNO® WARMING PRODUCTS:

THERMAL BALACLAVA SERIES

DIFFERENTIATED BY DESIGN

STRETCHABLE FLEECE

Stretchable fleece to ensure a great fit.

REFLECTIVE DETAIL

At center back of most balaclavas, a reflective accent has been added for visibility when in low light conditions.



LONG LENGTH

Long length for great coverage allowing for added warmth.

FLAME RESISTANT AND NON-FLAME RESISTANT OPTIONS

Depending on your needs, stay toasty warm and flame free in FR balaclavas - you've got options!



6823RT

	6970	ORDER MULTIPLE 1
BALACLAVA WITH HOT ROX™		
<ul style="list-style-type: none"> • 2-piece fleece, patented design • Built-in heat exchanger for warm air inhalation • Form-fitting design prevents eyewear from fogging • Adjustable mask with hook and loop attachments • Removable face mask 		
ITEM #	SIZE	COLOR
16971	—	Black
// PATENTED		

	6825	ORDER MULTIPLE 1
FR NOMEX BALACLAVA		
FR	NFPA 70E CAT 2	
	ATPV 9.7 cal/cm²	
<ul style="list-style-type: none"> • FR Nomex® fleece • Arc-rated; ATPV of 9.7 cal/cm² • Reflective accent for higher visibility • Stretchable and comfortable • Meets ASTM F1506; classified to NFPA 70E (CAT 2) 		
ITEM #	SIZE	COLOR
16825	—	Black

	6828	ORDER MULTIPLE 6
FR MODACRYLIC BALACLAVA		
FR	NFPA 70E CAT 2	
	ATPV 10.6 cal/cm²	
<ul style="list-style-type: none"> • FR modacrylic blend fleece • Arc-rated; ATPV of 10.6 cal/cm² • Reflective accent for higher visibility • EN 1149 (Anti-Static) • Meets ASTM F1506; classified to NFPA 70E (CAT 2) 		
ITEM #	SIZE	COLOR
16828	—	Black

	6824	ORDER MULTIPLE 12
WOOL BLEND BALACLAVA		
		
<ul style="list-style-type: none"> • Polyester/wool blend, moisture wicking • Easily fits underneath a hard hat • Long length, lightweight, and stretchable • Reflective accent for higher visibility 		
ITEM #	SIZE	COLOR
16824	—	Black

	6827	ORDER MULTIPLE 12
2-PC. FLEECE/NEOPRENE BALACLAVA		
		
<ul style="list-style-type: none"> • 2-pc polyester fleece with neoprene face mask • 1mm neoprene, one side nylon and one side fleece • Long length • Reflective accent for higher visibility • Hook and loop suspensions to attach to hard hat 		
ITEM #	SIZE	COLOR
16827	—	Black

	6823	ORDER MULTIPLE 12
WIND-PROOF HINGED FLEECE BALACLAVA		
		
<ul style="list-style-type: none"> • Fleece with wind-protectant fabric • Unique hinged design • 3-panel construction for comfort • Reflective accent for higher visibility 		
ITEM #	SIZE	COLOR
16823	—	Black

	6826	ORDER MULTIPLE 12
2-PC. FLEECE BALACLAVA		
		
<ul style="list-style-type: none"> • 2-pc polyester fleece attached by hook and loops • Unique hard hat hook and loop suspensions • Long length • Reflective accent for higher visibility 		
ITEM #	SIZE	COLOR
16826	—	Black

	6822	ORDER MULTIPLE 12
BALACLAVA WITH SPANDEX TOP		
		
<ul style="list-style-type: none"> • Polyester fleece for warmth • Lightweight, stretchable spandex top • Long length • Reflective accent for higher visibility 		
ITEM #	SIZE	COLOR
16822	—	Black

	6823_{RT}	ORDER MULTIPLE 6
WIND-PROOF HINGED BALACLAVA		
		
<ul style="list-style-type: none"> • Unique hinged design and 3-panel construction • Fleece & wind protectant fabric for all elements • Realtree Xtra® pattern for style • Brushed interior flat lock stitching for comfort • Updated longer length 		
ITEM #	SIZE	COLOR
16833	—	RT Camo

	6821	ORDER MULTIPLE	12
FLEECE BALACLAVA			
<ul style="list-style-type: none"> • Polyester fleece for warmth • Long length • Reflective accent for higher visibility 			
ITEM #	SIZE	COLOR	
16821	—	Black	

	6821	ORDER MULTIPLE	12
FLEECE BALACLAVA - HI-VIS LIME			
<ul style="list-style-type: none"> • Polyester fleece for warmth in extreme conditions • Updated longer length • Hi-vis lime fabric with reflective accents for visibility • Brushed interior fabric 			
ITEM #	SIZE	COLOR	
16829	—	HV Lime	

DANGER STARTS WELL BEFORE ZERO //

Cold Stress is just as dangerous as Heat Stress — but with its sneaky symptoms, it often goes undetected until it's too late. Awareness is key. Being informed about the dangers of Cold Stress and the importance of breathing warm air can help save lives and keep workers warm, comfortable, and productive.

FROST BITE

SYMPTOMS: PALE, WAXY-WHITE SKIN COLOR; SKIN BECOMES HARD AND NUMB; USUALLY AFFECTS EXTREMITIES INCLUDING EARS AND NOSE.

RESPONSE:

- Move the person to a warm dry area and remove any wet/tight clothing that may cut off blood circulation.
- DO NOT rub the affected area, rubbing can cause skin/tissue damage.
- Gently place the affected area in warm (105°F) water. Do not pour water directly on affected area. Warming will take 25-40 mins.
- Once normal feeling, movement and color return to area, dry and wrap to keep warm.
- Seek medical attention as soon as possible.

HYPOTHERMIA

SYMPTOMS: FATIGUE/DROWSINESS; UNCONTROLLED SHIVERING; COOL BLUISH SKIN; SLURRED SPEECH; CLUMSY MOVEMENTS; IRRITABLE/IRRATIONAL/CONFUSED BEHAVIOR.

RESPONSE:

- CALL FOR EMERGENCY HELP IMMEDIATELY.
- Move the person to a warm dry area and remove any wet/tight clothing and replace with dry clothing or wrap in a blanket.
- Drink warm, sweet drinks (sugar water or sports-type drinks). Avoid caffeinated drinks.
- Have the person move their arms and legs to create muscle heat. If unable to do so, place hot packs in armpits, groin, neck, and head. DO NOT rub the person or place them in warm water.

LOW TEMPERATURE + WIND SPEED + WETNESS = INJURIES & ILLNESS

Little Danger (Caution) Freezing to Exposed Flesh within 1 Hour:

Danger Freezing to Exposed Flesh within 1 Minute:

Extreme Danger Freezing to Exposed Flesh within 30 Seconds:

Source: OSHA; www.osha.gov

When the body is unable to warm itself, serious cold-related illnesses and injuries may occur, and permanent tissue damage and death may result.

Hypothermia can occur when land temperatures are above freezing or water temperatures are below 95°F/35°C. Cold-related illnesses can slowly overcome a person who has been chilled by low temperatures, brisk winds, or wet clothing.

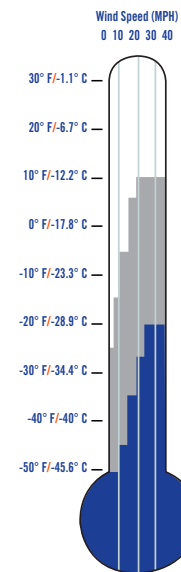

N-FERNO® WARMING PRODUCTS:

THERMAL HAT & CAP SERIES

DIFFERENTIATED BY DESIGN

REFLECTIVE DETAIL

Reflective accent for visibility when in low light conditions.

GREAT FIT

Snug fit to keep you safe and protected on the coldest of days.



DURABLE SHELL

Durable, wind- and water-resistant nylon shell, great for sheltering you from the winter cold.

ADDED WARMTH

3M™ Thinsulate™ technology brings you added warmth for those cold winter days when added insulation is appreciated.

	6802	ORDER MULTIPLE 1									
CLASSIC TRAPPER™ HAT											
<ul style="list-style-type: none"> • Faux fur detail and quilted satin crown lining • Durable, wind and water-resistant nylon shell • 60 grams of 3M™ Thinsulate™ Insulation • Button flaps with side holes for hearing • YKK buckle with strap 											
<table border="1" style="width: 100%;"> <thead> <tr> <th style="font-size: 0.8em;">ITEM #</th> <th style="font-size: 0.8em;">SIZE</th> <th style="font-size: 0.8em;">COLOR</th> </tr> </thead> <tbody> <tr> <td style="font-size: 0.8em;">16843</td> <td style="font-size: 0.8em;">S/M</td> <td style="font-size: 0.8em;">Black</td> </tr> <tr> <td style="font-size: 0.8em;">16845</td> <td style="font-size: 0.8em;">L/XL</td> <td style="font-size: 0.8em;">Black</td> </tr> </tbody> </table>			ITEM #	SIZE	COLOR	16843	S/M	Black	16845	L/XL	Black
ITEM #	SIZE	COLOR									
16843	S/M	Black									
16845	L/XL	Black									

	6802	ORDER MULTIPLE 1									
CLASSIC TRAPPER™ HAT - HI-VIS LIME											
<div style="display: flex; align-items: center;"> <div style="border: 1px solid black; padding: 2px; margin-right: 10px;"> NEW FOR '17 </div> <div style="text-align: right;"> </div> </div> <ul style="list-style-type: none"> • Durable, wind and water-resistant nylon shell • 60 grams of 3M™ Thinsulate™ Insulation • Hi-Vis Lime fabric + Reflective accents for visibility • Faux fur detail and quilted satin crown lining • Button flaps with side holes for hearing 											
<table border="1" style="width: 100%;"> <thead> <tr> <th style="font-size: 0.8em;">ITEM #</th> <th style="font-size: 0.8em;">SIZE</th> <th style="font-size: 0.8em;">COLOR</th> </tr> </thead> <tbody> <tr> <td style="font-size: 0.8em;">16853</td> <td style="font-size: 0.8em;">S/M</td> <td style="font-size: 0.8em;">HV Lime</td> </tr> <tr> <td style="font-size: 0.8em;">16855</td> <td style="font-size: 0.8em;">L/XL</td> <td style="font-size: 0.8em;">HV Lime</td> </tr> </tbody> </table>			ITEM #	SIZE	COLOR	16853	S/M	HV Lime	16855	L/XL	HV Lime
ITEM #	SIZE	COLOR									
16853	S/M	HV Lime									
16855	L/XL	HV Lime									

	6818	ORDER MULTIPLE 6
DRY ACRYLIC/FLEECE KNIT CAP		
<ul style="list-style-type: none"> • 100% acrylic shell • 3M™ Thinsulate™ flex insulation 40g • Soft fleece liner • One size 		
ITEM #	SIZE	COLOR
16818	—	Black

	6819_{BT}	ORDER MULTIPLE 6
BE TENACIOUS KNIT CAP		
<ul style="list-style-type: none"> • 100% acrylic shell • CoolMax™ lining • 100% tenacious look 		
ITEM #	SIZE	COLOR
16819BT	—	Black

	6820	ORDER MULTIPLE 1
FR MODACRYLIC KNIT CAP		
<ul style="list-style-type: none"> • Shell: modacrylic cotton blend • Lining: modacrylic cotton blend fleece • Reflective accent for higher visibility • Arc Rated; ATPV rating of 49.5 cal/cm² • Meets ASTM F1506 and NFPA 70E (CAT 4) 		
ITEM #	SIZE	COLOR
16820	—	Black

	6816	ORDER MULTIPLE 6
REVERSIBLE KNIT CAP		
<ul style="list-style-type: none"> • 100% poly/fleece reversible hat • Lime microfleece laminated to gray polyester • Stylish and comfortable 		
ITEM #	SIZE	COLOR
16816	—	HV Lime

	6810	ORDER MULTIPLE 12
STRETCH CAP - HALF CAP STYLE		
<ul style="list-style-type: none"> • 100% polyester knit • Half cap style • One size 		
ITEM #	SIZE	COLOR
16810	—	Black

	6815	ORDER MULTIPLE 12
STRETCH CAP - FULL FACE STYLE		
<ul style="list-style-type: none"> • 100% polyester knit • Full face style • One size 		
ITEM #	SIZE	COLOR
16815	—	Black

N-FERNO® WARMING PRODUCTS:

THERMAL ACCESSORY SERIES

DIFFERENTIATED BY DESIGN

HOURS OF WARMTH

Self-contained packs add heat for hours when exposed to air.

ALL NATURAL

All natural ingredients that heat up, providing you with all natural warmth.

ACTIVATION

Simply open pack and expose to oxygen.

STOCK UP AND PUT 'EM TO USE!
MOST N-FERNO® WINTER LINERS
INCLUDE POCKETS NEAR THE EARS
FOR WARMING PACK USE.
TOASTED EARS FEEL BETTER!

N-FERNO® WARMING PACKS

Whether in mittens or gloves, the 6990 Hand Warming Packs come in handy whenever you need to keep fingers from freezing. Most N-Ferno® Winter Liners come standard with warming pack pockets designed specifically for the versatile little power packs of heat to keep ears nice and toasty. You can even get crazy and toss one in a pocket! The 6992 Toe Warming Packs adhere to the insole of a shoe or boot to keep toes comfortable – so frostbite can fuggedaboutit. For those who need full foot heating, there's the 6995 Full Foot Warming Packs.



<p>HAND WARMING PACKS</p>		<p>6990</p>	<p>ORDER MULTIPLE 40</p>						
<ul style="list-style-type: none"> • To activate, just open the pack • Natural ingredients heat up on contact with oxygen • Seal in zip top bag and reuse the next day • Hand style warms up to 12 hours <table border="1" data-bbox="309 562 520 611"> <thead> <tr> <th>ITEM #</th> <th>SIZE</th> <th>COLOR</th> </tr> </thead> <tbody> <tr> <td>16990</td> <td>—</td> <td>—</td> </tr> </tbody> </table> <div style="text-align: right;">  </div>				ITEM #	SIZE	COLOR	16990	—	—
ITEM #	SIZE	COLOR							
16990	—	—							

<p>TOE WARMING PACKS</p>		<p>6992</p>	<p>ORDER MULTIPLE 40</p>						
<ul style="list-style-type: none"> • To activate, just open the pack • Natural ingredients heat up on contact with oxygen • Seal in zip top bag and reuse the next day • Toe style warms up to 5 hours <table border="1" data-bbox="309 1129 520 1178"> <thead> <tr> <th>ITEM #</th> <th>SIZE</th> <th>COLOR</th> </tr> </thead> <tbody> <tr> <td>16992</td> <td>—</td> <td>—</td> </tr> </tbody> </table> <div style="text-align: right;">  </div>				ITEM #	SIZE	COLOR	16992	—	—
ITEM #	SIZE	COLOR							
16992	—	—							

<p>FOOT WARMING PACKS</p>		<p>6995</p>	<p>ORDER MULTIPLE 20</p>						
<ul style="list-style-type: none"> • To activate, just open the pack • Natural ingredients heat up on contact with oxygen • Seal in zip top bag and reuse the next day • Foot style warms up to 7 hours <table border="1" data-bbox="309 1682 520 1730"> <thead> <tr> <th>ITEM #</th> <th>SIZE</th> <th>COLOR</th> </tr> </thead> <tbody> <tr> <td>16995</td> <td>—</td> <td>—</td> </tr> </tbody> </table> <div style="text-align: right;">  </div>				ITEM #	SIZE	COLOR	16995	—	—
ITEM #	SIZE	COLOR							
16995	—	—							



TREX™ FOOTWEAR ACCESSORIES

Brian Boitano WISHES he looked this smooth on the ice. While we can't guarantee you'll be pulling off triple Salchows with the greatest of ease, you will be making your way past the trickiest terrain without breaking a hip or chipping a tooth. How, you ask? TREX™ Ice Traction. TREX™ sneers at the frictionless ice world of winter and takes the sting out of the slick, snowy ground. Fear no terrain with TREX™.

FOOTWEAR ACCESSORIES // ICE TRACTION SERIES



6300 One-Piece



6304 Performance One-Piece



6310 Adjustable One-Piece



6315 Strap-On Heel



6301 Replacement Studs

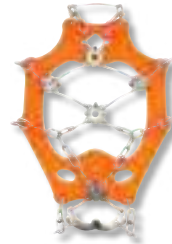

6320 Aggressive Spike

**TRACTION SPEAKS LOUDER
THAN WORDS.**



**TREX™
ICE TRACTION**

TREX™ ICE TRACTION:

ICE TRACTION SERIES

DIFFERENTIATED BY DESIGN

STRETCHABLE RUBBER

Stretchable rubber construction for fit and easy on/off.

CONFIGURATION OPTIONS

One-piece designs for easy on/off or cinch tight for all-day wear.

STEEL STUDS

Heat-treated carbon steel studs deliver tenacious grip and stability.

SIZING OPTIONS

Available in multiple sizes to fit almost any boot or shoe.



6300

ORDER MULTIPLE
1

ONE-PIECE ICE TRACTION DEVICE

UPDATED FOR
'17

- 8 rugged, heat-treated carbon steel studs
- Stretchable rubber for fit and easy on/off
- Flexible to -40°F (-40°C)
- U.S.: M (5-8), L (8-11), XL (11-15), 2XL (15-18)

ITEM #	SIZE	COLOR
16753	M	Black
16754	L	Black
16755	XL	Black
16756	2XL	Black

6304

ORDER MULTIPLE
1

PERFORMANCE ONE-PIECE ICE TRACTION DEVICE

- 12 rugged, heat-treated carbon steel studs
- Stretchable rubber construction
- Contoured, “step-in” design wraps around boots
- Flexible to -40°F (-40°C)
- U.S.: S (5-7), M (7-9), L (9-11), XL (11-14)

ITEM #	SIZE	COLOR
16782	S	Black
16783	M	Black
16784	L	Black
16785	XL	Black

6310

ORDER MULTIPLE
1

ADJUSTABLE ONE-PIECE ICE TRACTION DEVICE

- 10 rugged, heat-treated carbon steel studs
- Adjustable cord cinches tight for a secure fit
- Stretchable rubber for fit and easy on/off
- Flexible to -40°F (-40°C)
- U.S.: M (5-8), L (8-11), XL (11-14)

ITEM #	SIZE	COLOR
16773	M	Black
16774	L	Black
16775	XL	Black

6315

ORDER MULTIPLE
1

STRAP-ON HEEL ICE TRACTION DEVICE

- Corrosion-resistant steel heel plate
- Heel-only design leaves mid-foot free
- Channeled design will not retain ice or debris
- Rugged webbing, hook and loop strap
- Rear reflective accents enhance worker conspicuity

ITEM #	SIZE	COLOR
16777	M/L	Black
16778	XL+	Black

6301

ORDER MULTIPLE
1

REPLACEMENT STUDS

- 8 heat-treated carbon steel replacement studs
- Fits Trex™ 6300, 6304, and 6310 ice traction devices

ITEM #	SIZE	COLOR
16795	—	Orange

6320

ORDER MULTIPLE
1

AGGRESSIVE SPIKE ICE TRACTION DEVICE

- Stainless steel aggressive chain and spike system
- Innovative heel spike plate design
- Stretchable rubber ring ensures a secure fit
- Flexible to -40°F (-40°C)
- U.S.: S (5-7), M (7-9), L (9-11), XL (11-14)

ITEM #	SIZE	COLOR
16742	S	HV Orange
16743	M	HV Orange
16744	L	HV Orange
16745	XL	HV Orange

**FIND YOUR FIT, GET YOUR GEAR – BUT FIRST,
SPOT YOUR PAGE NUMBER OVER HERE.**



THE NITTY GRITTY

WHERE'S THAT...

Ask for directions when you're lost. Call a plumber when your sink is broken. Use this index when you need to find something in the workbook. You can do this; we believe in you.

Model	Page	Model	Page	Model	Page	Model	Page	Model	Page	Model	Page	Model	Page	Model	Page
100	52	818WP	31	3157	113	5120	122	5739	133	6480	179	6842	184	8260FR	65
100HV	52	8190D	30	3158	113	5125	122	5740	132	6485	165	6850	184	8280	69
200	45	819WP	30	3175	112	5130	125	5743	133	6486	165	6852	184	8281	69
230	45	820	24	3180	105	5143	123	5744	133	6490	178	6860	184	8287	74
260	45	821	27	3181	105	5144	123	5745	133	6500	165	6862	184	8289	68
300	44	860	25	3182	105	5151	169	5760	132	6550	165	6863	183	8291	69
315	44	900	32	3190	105	5155	169	5763	132	6602	159	6867	183	8293	70
325	45	901	33	3191	105	5156	169	5780	146	6602MF	157	6870	184	8295	69
335	45	910	33	3192	105	5157	169	5782	146	6603	159	6872	184	8310	66
340	45	920	29	3200	91	5158	169	5802	145	6605	164	6877	183	8320	66
342	41	921	29	3215	91	5159	169	5804	145	6609	165	6880	183	8330	66
344	41	922CR	29	3216	90	5180	125	5808	145	6615	164	6882	183	8356FR	66
345	41	924	29	3218	90	5181	125	5810	144	6630	164	6885	183	8365	74
347	42	925CR	28	3222	90	5182	125	5815	144	6650	164	6890	183	8377	73
350	42	925F(x)	28	3225	90	5183	125	5817	144	6660	165	6892	183	8379	73
355	42	925WP	29	3251	91	5184	125	5820	145	6665	162	6950	183	8380	73
357	42	1051	53	3275	91	5210	129	5840	145	6670CT	159	6952	183	8385	74
367	42	1100SF	52	3280	91	5215	129	5843	145	6685	162	6970	185	8386	74
375	47	1400UN	53	3311	111	5216	129	5870	146	6686	162	6990	191	8388	74
380	47	1500	53	3386	113	5220	129	5872	146	6700	160	6992	191	8391	70
385	47	1505	53	3400	117	5243	129	5875	147	6700CT	159	6995	191	8392	70
390	47	1600	53	3405	117	5244	129	5876	147	6700FR	161	8001	77	8393	70
400	56	1650	53	3410	116	5500	143	5888	146	6700MF	157	8003	77	8397	70
420	56	2000SF	52	3415	116	5504	143	5930	130	6705	160	8004	77	8910	67
500	57	3000	114	3540	117	5506S	143	5935	131	6705CT	158	8005	77	8911	67
600	57	3001	114	3700	106	5516	140	5937	131	6705FR	161	8006	77	8915	75
615	57	3025	114	3703	106	5517	139	5938	131	6705MF	157	8008	67	8918	75
620	57	3026	114	3713	106	5518	140	5940	130	6710	160	8010	71	8925	75
650	57	3100	111	3723	107	5522	142	5945	131	6710CT	158	8020	71	8930	77
655	57	3100F(x)	109	3724	107	5527	139	5960	131	6710FR	161	8040	71	8935	76
670	55	3101	111	3726	107	5528	139	5970	131	6710MF	157	8080	71	8935CT	159
675	55	3102	111	3750	107	5532	142	5975	131	6715	160	8089	69	8935MF	157
710	22	3102F(x)	110	3755	107	5538	139	6000	172	6715CT	158	8091	69	8950	95
710CR	23	3103	106	3770	107	5548	142	6010	173	6716	160	8140	71	8955	95
710LTR	23	3103F(x)	110	3780	107	5550	141	6094	173	6717	160	8205	62	8960	95
710TX	23	3107F(x)	110	3790	107	5555	141	6095	173	6717CT	159	8210	62	9000	33
720	25	3108	111	3800	117	5560	141	6098	172	6717FR	161	8215	62	9002	33
720LTR	25	3108F(x)	109	4000	55	5561	140	6100	173	6802	188	8216	63	9012	33
730	34	3109	111	4010	55	5562	140	6190	173	6810	189	8220	63	9015	32
7300D	34	3109F(x)	110	4020	55	5563	140	6193	173	6815	189	8225	63	BALDR	87
740	34	3110	111	5005	127	5564	140	6215	166	6816	189	8229	63	DAGR	87
760	24	3110F(x)	109	5008	127	5567	142	6220	167	6818	189	8230	63	ERDA	88
800	33	3111	111	5020	123	5638	133	6230	166	6819BT	189	8235	63	KVASIR	88
810	27	3114	112	5025	123	5650	132	6240	167	6820	189	8240	65	LOKI	89
811	26	3115	112	5030	123	5653	132	6300	195	6821	187	8244	65	NJORD	89
812	26	3116	112	5060	127	5700	142	6301	195	6822	186	8245	65	ODIN	86
812CR	27	3117F(x)	110	5063	127	5706	142	6304	195	6823	186	8246	64	THOR	87
812TX	27	3118F(x)	109	5080	124	5725	139	6310	195	6824	186	8248	64	TYR	89
814	31	3119	111	5082	124	5728	139	6315	195	6825	185	8249	64	VALKYRIE	88
815	27	3119F(x)	110	5092	124	5730	132	6320	195	6826	186	8250	64		
816	31	3130	112	5093	124	5733	133	6435	179	6827	186	8253	64		
817	31	3150	113	5115	122	5737	133	6465	179	6828	185	8254	65		
817WP	31	3155	113	5116	122	5738	133	6470	179	6840	184	8255	65		

PICK ON SOMEONE YOUR OWN SIZE

With our sizing options, fitting in is as easy as putting on Velero® sneakers. Our Tenacious Work Gear® comes in a wide variety of sizes and styles. So put those middle school memories to rest. No more sitting alone at lunch 'cause your parents wouldn't spring for "The Rachel" or your Tamagotchi went through the wash. Size up right, here or on www.ergodyne.com.

					
ProFlex® Gloves	ProFlex® Wrist Supports	ProFlex® Wrist Wraps	ProFlex® Elbow Supports	Ergodyne® Knee Sleeves	
Measure around the palm. DO NOT include the thumb area. Use the size chart across the bottom of this page to double check your size choice.	Measure around the smallest part of the wrist.	Measure around the smallest part of the wrist.	In a relaxed position, measure around the widest area of the forearm just below the elbow. For best fit, an elbow support should sit about 2-3 finger widths below the elbow crease.	Measure around the center of the knee with the knee extended.	
SIZE:	FITS HANDS:	FITS WRISTS:	FITS WRISTS:	FITS ELBOWS:	FITS KNEES:
X-Small	Sz. 6: up to 7" (18 cm)	-----	-----	up to 9" (23 cm)	12-13" (31-33 cm)
Small	Sz. 7: 7-8" (18-20 cm)	up to 6" (15 cm)	-----	9-10" (23-25 cm)	13-14" (33-36 cm)
Medium	Sz. 8: 8-9" (20-23 cm)	6-7" (15-18 cm)	-----	10-11" (25-28 cm)	14-15" (36-38 cm)
Large	Sz. 9: 9-10" (23-25 cm)	7-8" (18-20 cm)	-----	11-12" (28-30 cm)	15-16" (38-41 cm)
X-Large	Sz.10: 10-11" (25-28 cm)	8" and over (20 cm)	-----	12-13" (30-33 cm)	16-18" (41-46 cm)
2XLarge	Sz.11: 11-12" (28-30 cm)	-----	-----	13-16" (33-36 cm)	18-20" (46-51 cm)
3XLarge	Sz.12: 12-13" (30-32 cm)	-----	-----	-----	-----
4XLarge	-----	-----	-----	-----	-----
S/M	-----	-----	5-7" (15-19 cm)	-----	-----
L/XL	-----	-----	7-9" (19-23 cm)	-----	-----

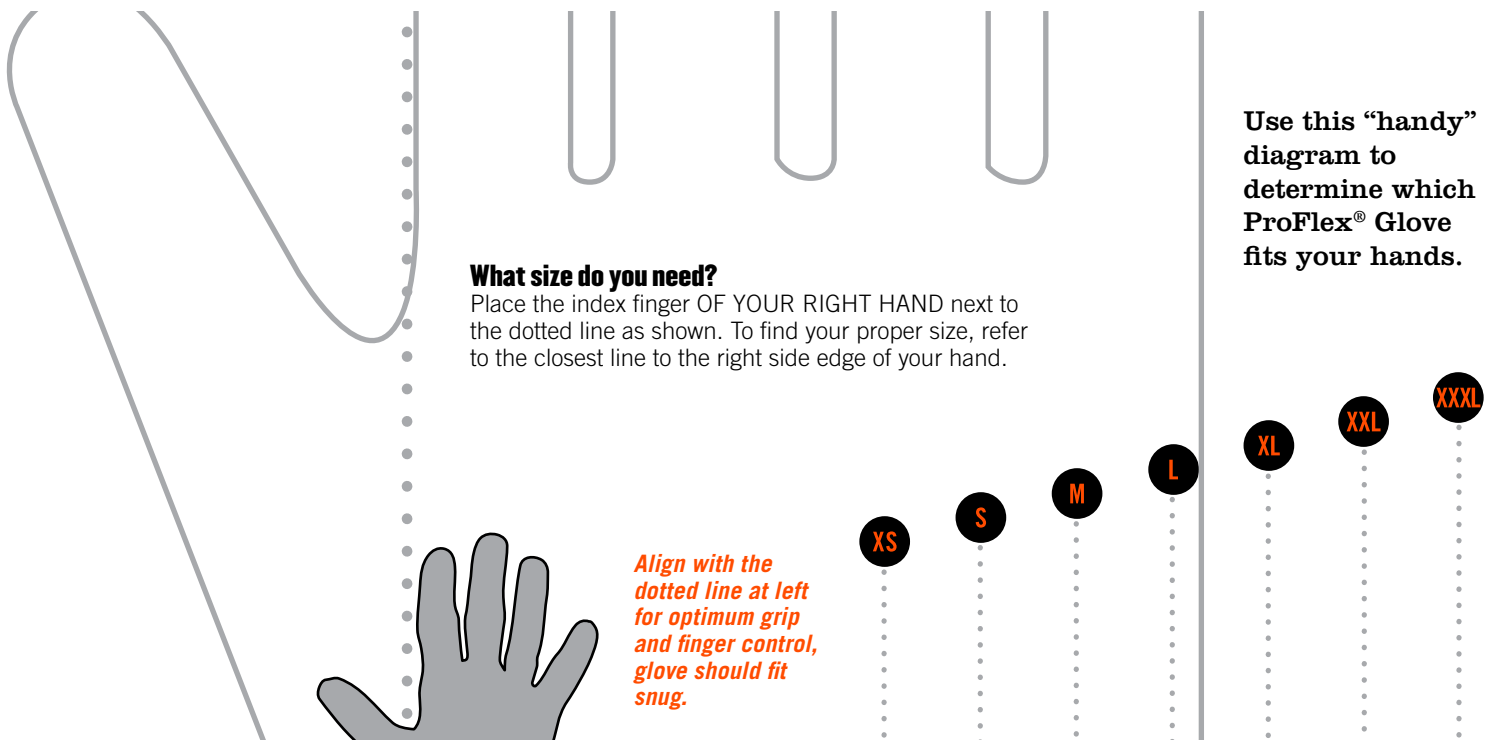

**TREX™
Ice Traction**

Use shoe or boot size to determine the appropriate size. TREX™ Ice Traction should fit snugly.



SIZE:	6300			6310			6304 // 6320			6315		
	USM	UK	EU	USM	UK	EU	USM	UK	EU	USM	UK	EU
Small	-----			-----			5-7	4.5-6.5	37-40	5-7	4.5-6.5	37-40
Medium	5-8	4.5-7.5	37-41	5-8	4.5-7.5	37-41	7-9	6.5-8.5	40-42	7-9	6.5-8.5	40-42
Large	8-11	7.5-10.5	41-44	8-11	7.5-10.5	41-44	9-11	8.5-10.5	42-44	9-11	8.5-10.5	42-44
X-Large	11-15	10.5-14.5	44-48	11-14	10.5-13.5	44-47	11-14	10.5-13.5	44-47	11-14	10.5-13.5	44-47
2XLarge	-----			-----			-----			-----		
3XLarge	-----			-----			-----			-----		

**ProFlex®
Back Supports**

Measure around the waist. A support should fit snugly, but not so tightly that it cannot be cinched firmly when ready to lift.

**N-Ferno®
Base Layer Bottoms**

Use standard waist size measurement.

**N-Ferno®
Base Layer Shirts**

Individually sized M, L, XL, 2XL, 3XL and follow standard sizing.

**N-Ferno®
Outerwear Jacket**

Bring tape measure around the widest part of your chest, under your arms, completely around your torso.

**N-Ferno®
Outerwear Bibs**

Use standard waist size measurement.

SIZE:	FITS WAISTS:	FITS WAISTS:	FITS CHEST SIZE:	FITS CHEST SIZE:	FITS WAISTS:
X-Small	Up to 25" (64 cm)	-----	-----	-----	-----
Small	25-30" (64-76cm)	-----	-----	-----	-----
Medium	30-34" (76-86cm)	31-34" (79-86cm)	38-41" (97-104cm)	36-38" (91-97 cm)	30-34" (76-86 cm)
Large	34-38" (86-97cm)	34-37" (86-94cm)	41-44" (104-112cm)	38-42" (97-107 cm)	34-38" (86-97 cm)
X-Large	38-42" (97-107cm)	37-40" (94-102cm)	44-47" (112-119cm)	42-46" (107-117 cm)	38-42" (97-107 cm)
2XLarge	42-46" (107-117cm)	40-44" (102-112cm)	47-50" (119-127cm)	46-50" (117-127 cm)	42-46" (107-117 cm)
3XLarge	46-52" (117-132cm)	44-48" (112-122cm)	50-53" (127-135cm)	50-54" (127-137 cm)	46-48" (117-123 cm)
4XLarge	52-58" (132-147cm)	-----	-----	-----	-----



**GloWear®
Hi-Vis Shirts**

T-Shirt, Polo Shirt, and Sweatshirt are individually sized S, M, L, XL, 2XL, 3XL, 4XL, 5XL and follow standard sizing.

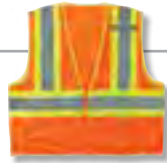

**GloWear®
Hi-Vis Vests**

Vests & Vests w/Sleeves are sold in combined sizes: S/M, L/XL, 2XL/3XL, and 4XL/5XL. *Note: 8240HL is available in M/L and XL/2XL only.



**GloWear® Pants
8910/8911**

Use standard waist size measurement.



**GloWear® Pants
8915/8925**

Use standard waist size measurement.



**GloWear®
Jackets**

Bring tape measure around the widest part of your chest, under your arms, completely around your torso.

SIZE:	FITS CHEST SIZE:	FITS CHEST SIZE:	FITS WAIST SIZE:	FITS WAIST SIZE:	FITS CHEST SIZE:
Small	34-36" (86-91 cm)	-----	-----	Up to 30" (76 cm)	34-36" (86-91 cm)
Medium	36-38" (91-97 cm)	-----	-----	30-34" (76-86 cm)	36-38" (91-97 cm)
Large	38-42" (97-107 cm)	-----	-----	34-38" (86-97 cm)	38-42" (97-107 cm)
X-Large	42-46" (107-117 cm)	-----	-----	38-42" (97-107 cm)	42-46" (107-117 cm)
2XLarge	46-50" (117-127 cm)	-----	-----	42-46" (107-117 cm)	46-50" (117-127 cm)
3XLarge	50-54" (127-137 cm)	-----	-----	46-48" (117-123 cm)	50-54" (127-137 cm)
4XLarge	54-58" (137-147 cm)	-----	-----	48-50" (123-127 cm)	54-58" (137-147 cm)
5XLarge	58-62" (147-157 cm)	-----	-----	50-54" (127-137 cm)	58-62" (147-157 cm)
S/M	-----	36-44" (91-112 cm)	Up to 40" (102 cm)	-----	-----
M/L (8240HL only)	-----	40-48" (102-123 cm)*	-----	-----	-----
L/XL	-----	44-52" (112-132 cm)	40-46" (102-117 cm)	-----	-----
XL/2XL (8240HL only)	-----	48-56" (123-142 cm)*	-----	-----	-----
2XL/3XL	-----	52-58" (132-147 cm)	46-52" (117-132 cm)	-----	-----
4XL/5XL	-----	58-64" (147-163 cm)	52-58" (132-147 cm)	-----	-----

For full sizing of all Ergodyne items, visit www.ergodyne.com



**Chill-Its®
Cooling Vest 6665**

Bring tape measure around the widest part of your chest, under your arms, completely around your torso.



**Chill-Its®
Cooling Vest 6685**

Bring tape measure around the widest part of your chest, under your arms, completely around your torso.



**Chill-Its®
Phase Change Vests**

Bring tape measure around the widest part of your chest, under your arms, completely around your torso.



**Arsenal®
Synthetic Rigs**

Choose your synthetic belt size based on your pant waist size.

SIZE:	FITS CHEST SIZE:	FITS CHEST SIZE:	FITS CHEST SIZE:	FITS WAIST SIZE:
X-Small	-----	-----	-----	-----
Small	-----	-----	32-40" (81-102 cm)	-----
Medium	36-38" (91-97 cm)	38-41" (97-104 cm)	32-40" (81-102 cm)	-----
Large	38-42" (97-107 cm)	41-44" (104-112 cm)	40-52" (102-132 cm)	29-38" (74-97cm)
X-Large	42-46" (107-117 cm)	44-47" (112-119 cm)	40-52" (102-132 cm)	36-44" (91-112cm)
2XLarge	46-50" (117-127 cm)	47-50" (119-127 cm)	-----	42-49" (107-125cm)
3XLarge	50-54" (127-137 cm)	50-53" (127-135 cm)	-----	-----
4XLarge	-----	53-56" (135-142 cm)	-----	-----

SIZE UP THE SITUATION

Improperly sized gear is a prime cause of heartache and sadness. Remember when you showed up at school wearing high-water pants? Of course that's nothing compared to the crack-tacular combination of too-short shirt and too-loose pants. Don't let these calamities occur. Your gear will be more effective and comfortable if you choose appropriate sizes.

CHEST: Measurement should be taken around the fullest part of the chest with arms down, just under the arms and across the shoulder blades.

WAIST: Measure around waist (not pulling tightly) at the height you prefer to wear the waistband.

INSEAM: Take a pair of pants that fit you well and measure from the crotch to the bottom of the leg.

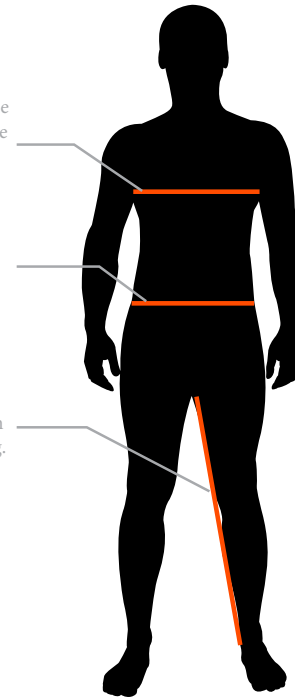

WE STAND BEHIND EVERYTHING WE MAKE AND GUARANTEE OUR PRODUCTS TO BE FREE OF DEFECTS IN MATERIALS AND WORKMANSHIP TO THE ORIGINAL PURCHASER FOR THE LIFETIME OF THE PRODUCT. (DAMAGE, ABUSE, AND/OR NORMAL WEAR ARE NOT COVERED. DON'T LAWYERS JUST BRING YOU DOWN?)

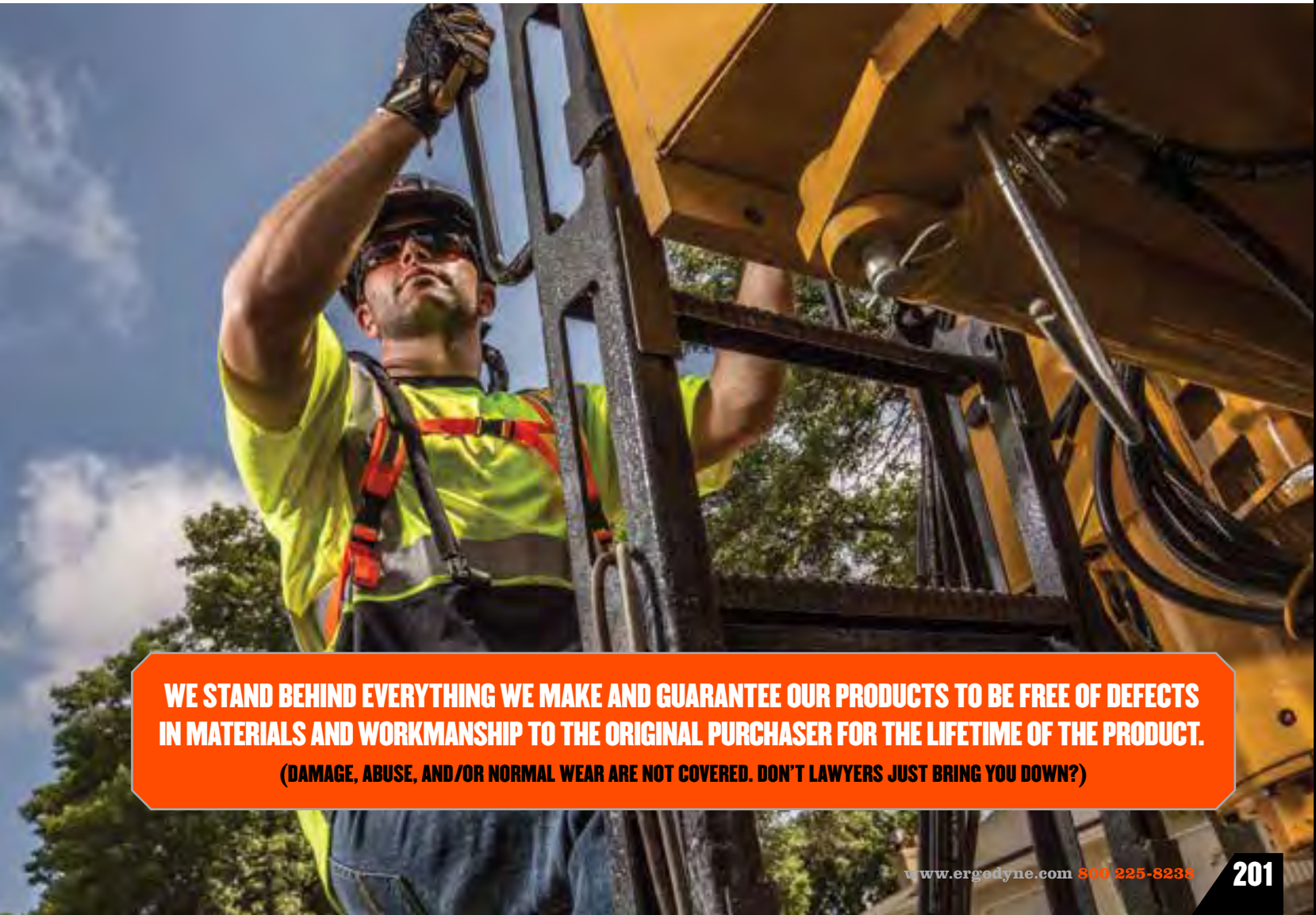



**WORK SAFELY //
LIVE TENACIOUSLY**





**Tool Box
Machine Shop
Wrenching on Cars**

**Dirt Bikes
Denim Blue
Closing Down Bars**

**Duck Blinds
Daily Grinds
Steel Toed Boots**

**Red Blooded
Clear Eyed
Putting Down Roots**

**Campgrounds
Sturgis
Hook, Line, and Sinker**

**Cookouts
Miller Time
Sun Grows Pinker**

**Trench and Dredge
Lay out Block
Snap the Line
Punch the Clock**

**Keep it Safe
Best in Show
Bell Rings
Time to Go**

**Homeward Bound
Wild and Free
A Life Well Lived
Tenaciously**



Do not burn yourselves out. Be as I am — a reluctant enthusiast... a part-time crusader, a half-hearted fanatic. Save the other half of yourselves and your lives for pleasure and adventure. It is not enough to fight for the land; it is even more important to enjoy it. While you can. While it's still here. So get out there and hunt and fish and mess around with your friends, ramble out yonder and explore the forests, climb the mountains, bag the peaks, run the rivers, breathe deep of that yet sweet and lucid air, sit quietly for awhile and contemplate the precious stillness, the lovely, mysterious, and awesome space. Enjoy yourselves, keep your brain in your head and your head firmly attached to the body, the body active and alive, and I promise you this much; I promise you this one sweet victory over our enemies, over those desk-bound men and women with their hearts in a safe deposit box, and their eyes hypnotized by desk calculators. I promise you this; You will outlive the bastards.

– Edward Abbey

MEMBER ASSOCIATIONS:



INTERGALACTIC HEADQUARTERS:
44° 58' 18.31" N 93° 09' 12.88" W ALT. 934 FT.
1021 BANDANA BOULEVARD EAST
SUITE 220 SAINT PAUL, MN, USA 55108
PHONE 651 642 9889 // 800 225 8238
WWW.ERGODYNE.COM

©2016 Tenacious Holdings Inc. All Rights Reserved. All Wrongs Reversed. Ergodyne, Ergoman and Ergoman design, Ergodyne Badge, Tenacious Work Gear Logo, Ergodyne Tenacious Work Gear, Arsenal, Chill-Its, CR925Fx Dorsal Impact, DROP COPS, GloWear, Nu202, Squids, Sticky Fingers, ProFlex, ProFlex (Expand), CORE Performance Work Wear, N-Ferno, SHAX and Skullerz are registered trademarks of Ergodyne and protected in the U.S. and abroad. Be Tenacious, BET (Beverage Extrication Tool), Buddy System, Orange Squad, Squad Box, Team Extreme, Team Tenacious, Tenacious Toilet, QuickCuff Open-Center Stay, Perfor-air, Power Panel Positioner, Storm Drains, Products for Occupational Athletes, TREX, Hot Rox, Tenacious-U, Tool Tails, Tool Trap, Tenacious Testers, Tenacious Nation, Make the Workplace a Betterplace, Drops Free Zone and Tenacious Talks are trademarks of Ergodyne. Trademarks of companies mentioned herein appear for identification purposes only and are the property of their respective companies. All other product names mentioned herein may be trademarks and/or registered trademarks of their respective owners. Ergodyne is a division of Tenacious Holdings Inc.