

Peerless Industrial Group

1416 East Sanborn St.,
Winona MN 55987

Phone: (800) 873-1916 • **Fax:** (800) 356-1149

Email: custserv@peerlesschain.com

Website: www.peerlesschain.com



PEERLESS[®]
INDUSTRIAL GROUP

Item # 8063705, Peer-Lift Bolt, Nut & Cotter Anchor Shackles - Alloy Pin, Carbon Body



8063705

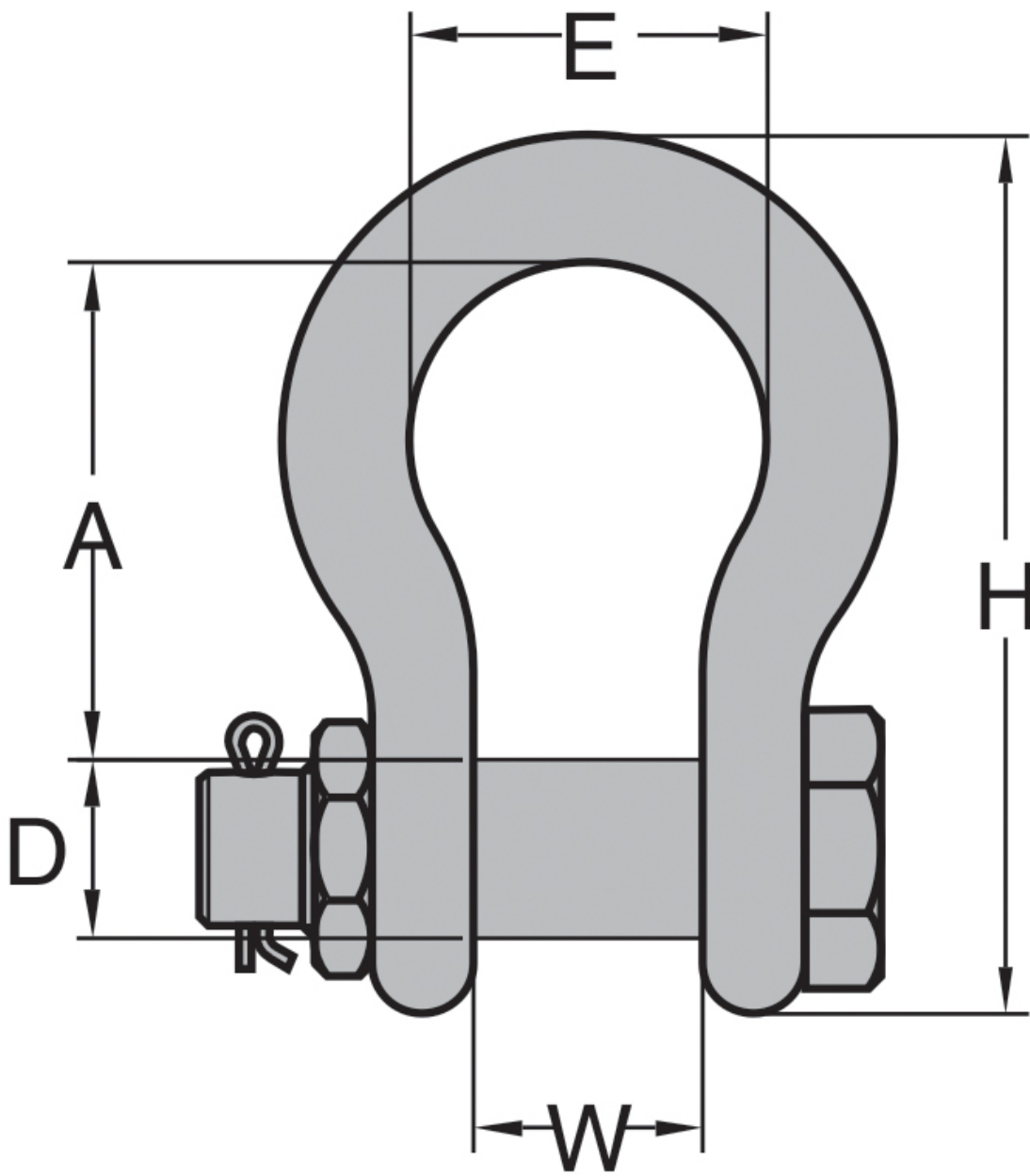

Trade Size (Inches)

3/4

Pin Dia. (D)

7/8

Dim A

2.812

Dim B

0.71

Dim E

1.75

Dim G

2.125

Dim W

1.25

Quantity Per Pkg.

25

Lbs. Per Ea.

2.72

Working Load Limit (Tons)

4-3/4