

# User Manual

## Smart-UPS™ Ultra On-Line

### Uninterruptible Power Supply

SRTL3KRM1UWC  
SRTL3KRM1UWNC  
SRTL3KRM1UIC  
SRTL3KRM1UINC  
SRTL2K2RM1UWC  
SRTL2K2RM1UWNC  
SRTL2K2RM1UIC  
SRTL2K2RM1UINC

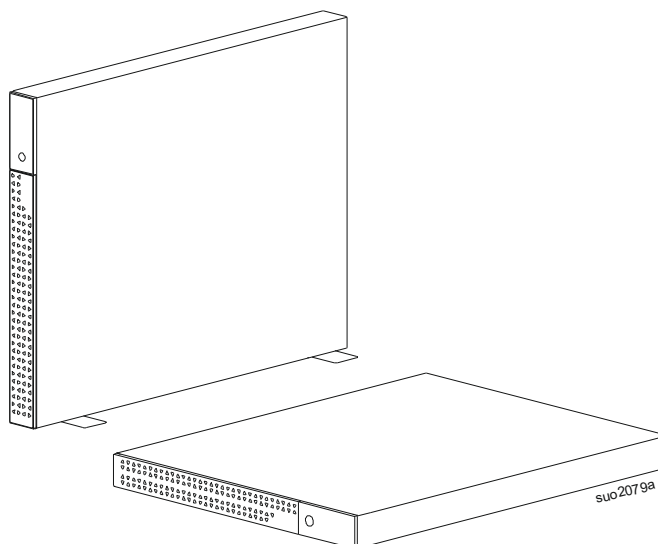

Life Is On

**Schneider**  
Electric



# General Information

## Important Safety Instructions

SAVE THESE INSTRUCTIONS - This manual contains important instructions that should be followed during installation and maintenance of the APC™ Smart-UPS™ Ultra and batteries.



Read the instructions carefully to become familiar with the equipment before attempting to install and operate the equipment UPS.

The following special messages may appear throughout this manual or on the equipment to warn of potential hazards or to call attention to information that clarifies or simplifies a procedure.



The addition of this symbol either to a “Danger” or “Warning” safety label indicates that an electrical hazard exists which will result in personal injury if the instructions are not followed.



This is the safety alert symbol. It is used to alert you to potential personal injury hazards. Obey all safety messages that follow this symbol to avoid possible injury or death.

### **DANGER**

**DANGER** indicates a hazardous situation which, if not avoided, **will result in** death or serious injury.

### **WARNING**

**WARNING** indicates a hazardous situation which, if not avoided, **could result in** death or serious injury.







### **CAUTION**

**CAUTION** indicates a hazardous situation which, if not avoided, **could result in** minor or moderate injury.

### **NOTICE**

**NOTICE** is used to address practices not related to physical injury.

## Product Handling Guidelines

 <18 kg <40 lb	 18-32 kg 40-70 lb	 32-55 kg 70-120 lb	 >55 kg >120 lb		
---	---	--	---	---	---

# Safety and General Information

- Adhere to all national and local electrical codes.
- All wiring must be performed by a qualified electrician.
- Connect only SELV circuits to all the communication ports.
- **Changes and modifications to this unit not expressly approved by Schneider Electric could void the warranty.**
- This UPS is intended for indoor use only.
- Do not operate this UPS in direct sunlight, in contact with fluids, or where there is excessive dust or humidity.
- Be sure the air vents on the UPS are not blocked. Allow adequate space for proper ventilation.
- For a UPS with a factory installed power cord, connect the UPS power cable directly to a wall outlet. Do not use surge protectors or extension cords.
- The equipment is heavy. Always practice safe lifting techniques adequate for the weight of the equipment.
- The replaceable battery modules (RBM) are heavy. Remove the RBMs before installing the UPS and external battery packs (XLBPs), in a rack.
- Always install XLBPs at the bottom in rack-mount configurations. The UPS must be installed above the XLBPs.
- Always install peripheral equipment above the UPS in rack-mount configurations.
- Additional safety information can be found in the Safety Guide supplied with this unit.

## Deenergizing safety

The UPS contains RBM and may present a shock hazard even when disconnected from the branch circuit (mains). Before installing or servicing the equipment check that the:

- input circuit breaker is in the OFF position.
- RBMs are removed.
- XLBPs are disconnected.

## Electrical safety

- Do not handle any metallic connector before power has been disconnected.
- The connection to the branch circuit (mains) must be performed by a qualified electrician.
- The protective earth conductor for the UPS carries the leakage current from the load devices (computer equipment). An insulated ground conductor is to be installed as part of the branch circuit that supplies the UPS. The conductor must have the same size and insulation material as the grounded and ungrounded branch circuit supply conductors. The conductor will typically be green and with or without a yellow stripe.
- The UPS input ground conductor must be properly bonded to protective earth at the service panel.
- Leakage current for a pluggable Type A UPS may exceed 3.5 mA when a separate ground terminal is used.
- If the UPS input power is supplied by a separately derived system, the ground conductor must be properly bonded at the supply transformer or motor generator set.

## Battery safety

### **WARNING**

#### **RISK OF CHEMICAL HAZARD AND EXCESSIVE HEAT**

- Replace the RBM at least every 10 years, or at the end of its service life, whichever is earlier.
- Replace the RBM immediately when the UPS indicates battery replacement is necessary.
- Replace RBM with the same type as originally installed in the equipment.
- Replace the RBM immediately when the UPS indicates a battery over-temperature condition or UPS internal over-temperature. Power off the UPS, unplug it from the AC input, and disconnect the RBM. Do not operate the UPS until the RBM has been replaced.
- \*Replace all XLBPs which are older than one year, when installing additional XLBPs.

**Failure to follow these instructions can result in death or serious injury.**

\* Contact APC by Schneider Electric Worldwide Customer Support to determine the age of the installed RBMs.

**Note:** Servicing of battery modules should be performed or supervised by personnel knowledgeable about batteries and the required precautions.

- The RBMs typically last for eight to ten years. Environmental factors impact life of the RBM. Elevated ambient temperatures, poor quality utility power, and frequent short duration discharges will shorten battery life.
- For longer performance of the RBM, the ambient temperature should be maintained between 68 and 77 °F (20 and 25 °C).
- Schneider Electric uses Maintenance-free Lithium-Ion batteries. Under normal use and handling, there is no contact with the internal components of the RBM.
- Do not drive nails into the RBM.
- Do not strike the RBM with a hammer.
- Do not stand on the RBM.
- Do not short circuit RBM.
- Do not place or use the RBM near heat or fire.
- Do not use a dropped, damaged or deformed RBM.
- Do not use the RBM to power other equipment.
- **CAUTION:** A battery can present a risk of electrical shock and high short-circuit current. Contact with any part of a grounded battery can result in electrical shock. The following precautions should be observed when working on RBMs:
  - Disconnect the charging source prior to connecting or disconnecting battery terminals.
  - Do not wear any metal objects including watches and rings.
  - Do not lay tools or metal parts on top of batteries.
  - Use tools with insulated handles.
  - Wear rubber gloves and boots.
  - Determine if RBM is either intentionally or inadvertently grounded. Contact with any part of a grounded battery can result in electric shock and burns by high short-circuit current. The risk of such hazards can be reduced if grounds are removed during installation and maintenance by a skilled person.
- **CAUTION:** Before installing or replacing the RBMs, remove jewelry such as wristwatches and rings. High short circuit current through conductive materials could cause severe burns.
- **CAUTION:** Do not dispose of RBMs in a fire. The RBM may explode.
- **CAUTION:** Do not open or tamper with the RBM enclosure. Doing so will expose the cell terminals which poses an energy hazard.
- **CAUTION:** Do not open or mutilate RBM. Released material is harmful to the skin and eyes and may be toxic.
- **CAUTION:** Failed RBMs can reach temperatures that exceed the burn thresholds for touchable surfaces.

## General information











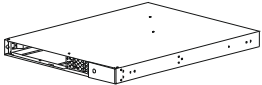

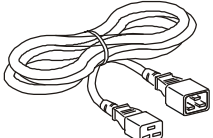

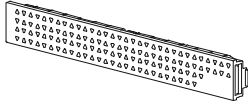
- The UPS will recognize as many as 5 XLBPs (SRTL50RMBP1U-LI) connected to the UPS.  
**Note: For each XLBP added, increased recharge time will be required.**
- The model and serial numbers are located on a small, rear panel label. An additional label is located on the draw out tray behind the front bezel. Refer “Location of QR Codes for Product information and Registration” on page 8 for details.
- Always recycle used RBMs.
- Recycle the package materials or save them for reuse.

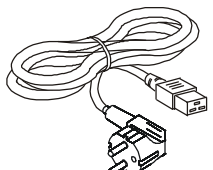
## Radio Frequency Warning

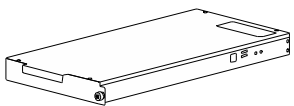
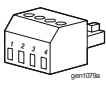
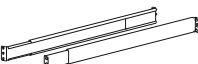
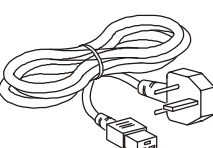
This is a category C2 UPS product. In a residential environment, this product may cause radio interference, in which case the user may be required to take additional measures.

# Package Contents

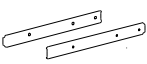
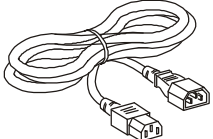
Inspect the contents upon receipt. Notify the carrier and dealer if the unit is damaged.

<p>UPS</p> 	<p>USB cable</p> 	<p>User documentation</p> 	<p>3 input power cords IEC C20 – C19</p> 	<p>Flat head screws (10X)</p> 
<p>Front bezel</p> 	<p>Network cable</p> 	<p>PCSS insert</p> 	<p>IEC C19 – CEE 7</p> 	<p>Washers (8X)</p> 
<p>Battery module</p> 	<p>EPO terminals</p> 	<p>Rails</p> 	<p>IEC C19 - BS 1363</p> 	<p>Ornamental Screws (2X)</p> 
<p>Rack-mount / wall mount brackets (4X)</p> 	<p>Stabilizers (4X)</p> 	<p>Cleats</p> 	<p>IEC C13 - C14</p> 	<p>Panhead screws (8X)</p> 
<p>Flat head screws (8X)</p> 				

## Product Description

The APC Smart-UPS Ultra SRTL is a high power density and high performance uninterruptible power supply (UPS). The UPS helps to provide protection for electronic equipment from utility power blackouts, brownouts, sags, surges, small utility power fluctuations and large disturbances. The UPS also provides battery backup power for connected equipment until utility power returns to acceptable levels or the batteries are completely discharged.

This user manual is available on [www.schneider-electric.com](http://www.schneider-electric.com). By scanning the QR code provided with the specific product, you can visit the product webpage and get all relevant product information.

# Product Overview

## Specifications

For additional specifications visit our web site, [www.schneider-electric.com](http://www.schneider-electric.com).

Applicable power grid power distribution system	TN Power System
Overvoltage category	II
Applicable standard	IEC 62040-1

## Environmental

Temperature	Operating	0 to 40 °C (32 to 104 °F)
	Storage	-15 to 45 °C (5 to 113 °F)
Elevation	Operating	0 - 3,000 m (0 - 10,000 ft)
	Storage	0 - 15,000 m (50,000 ft)
Humidity	0% to 95% relative humidity, non-condensing	
Pollution degree	2	
International Protection Code	IP20	
<b>Note:</b> Charge the battery modules every twelve months during storage. Environmental factors impact battery life. Elevated ambient temperatures, high humidity, poor quality mains power, and frequent short duration discharges will shorten battery life.		

## Physical

The products are heavy. Follow all lifting guidelines.

Unit weight, without packaging (approx.)	14 kg (30.9lb)
Unit weight, with packaging	24.2 kg (53.3 lb)
Unit dimensions, without packaging Height x Width x Depth	43 x 432 x 560 mm (1.7 x 17 x 22 in)
Unit dimensions, with packaging Height x Width x Depth	278 x 576 x 764 mm (10.95 x 22.68 x 30.10 in)

## Electrical

**CAUTION:** To reduce the risk of fire, connect only to a circuit provided with recommended maximum branch circuit overcurrent protection in accordance with the National Electrical Code, ANSI/NFPA 70 and the Canadian Electrical Code, Part I, C22.1., for North America, IEC/EN 60934 for Europe, 208V single phase without N in North American, recommended Double - Pole branch circuit over current protection.

Models	SRTL3KRM1UWC SRTL3KRM1UWNC	SRTL3KRM1UIC SRTL3KRM1UINC	SRTL2K2RM1UWC SRTL2K2RM1UWNC	SRTL2K2RM1UIC SRTL2K2RM1UINC
Maximum Output Rating	3000 VA / 3000 W		2200 VA / 2200 W	
Branch Circuit Overcurrent Rating / Building Circuit Breaker (CB) Current Rating	250V; 20A (North American), 250V;16A (Europe)			
<b>Output</b>				
Output Frequency	50/60 Hz ± 3 Hz			
Nominal Output Voltage	208 V, 220 V, 230 V, 240 V	220 V, 230 V, 240 V	208 V, 220 V, 230 V, 240 V	220 V, 230 V, 240 V
<b>Connector Type</b>				
Main Outlet Group	(1) IEC 320 C13 + (1) C19			
Switched Outlet Group	(2) IEC 320 C13 + (1) C19			
<b>Input</b>				
Connector Type	IEC C20			
Input Frequency	50/60 Hz ± 3 Hz (auto sensing)			
Nominal Input Voltage	208 V ~ 240 V	220 V ~ 240 V	208 V ~ 240 V	220 V ~ 240 V
Nominal Input Current	16 A			
Input Voltage Range	160 to 275 V ± 5 V			



# Battery

<b>Battery type</b>	Lithium-Ion
<b>Internal RBM</b> Refer to the appropriate replacement battery user manual for installation instructions. Contact your dealer or visit our web site, <a href="http://www.schneider-electric.com">www.schneider-electric.com</a> for information on replacement batteries.	APCRBC173-LI
<b>Number of RBMs in UPS</b>	1
<b>Voltage of each RBM</b>	50.4 V
<b>Ah rating</b>	5.16 Ah
<b>Compatible XLBP</b>	SRTL50RMBP1U-LI

## Front Panel Features

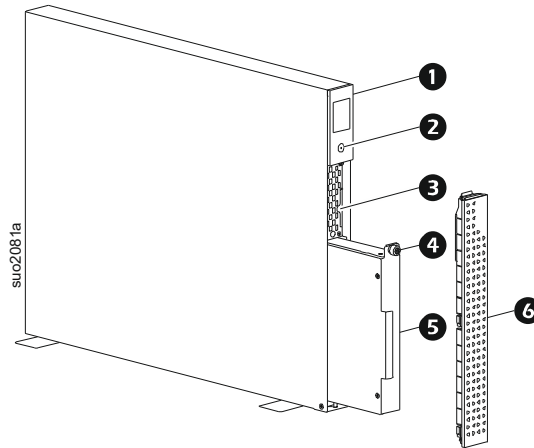

<b>1</b>	<b>LCD display</b>
<b>2</b>	<b>POWER button</b>
<b>3</b>	<b>Draw out tray containing QR codes and MAC Address label of NMC</b>
<b>4</b>	<b>RBM thumbscrew</b>
<b>5</b>	<b>RBM</b>
<b>6</b>	<b>Front bezel</b>

# Location of QR Codes for Product information and Registration

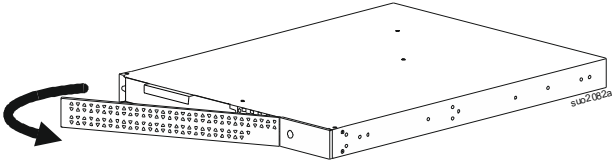
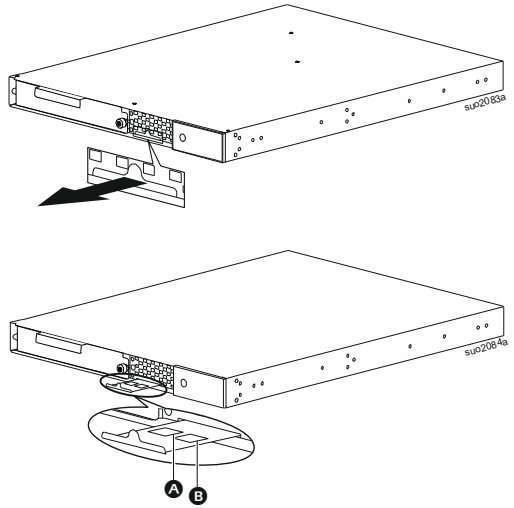
<p><b>1</b></p>	<p>Remove the front bezel</p>	
<p><b>2</b></p>	<p>Pull out the tray.</p> <p><b>A</b> QR code for SmartConnect. Refer “APC SmartConnect” on page 26 for details.</p> <p><b>B</b> MAC address label for downloading user documentation and product information.</p>	

## Rear Panel Features

**Note:** Refer to the table “Key to identify rear panel features” on page 9, that provides a key to the callout numbers for the rear panel graphics depicted in this manual.

### SRTL3KRM1U WNC/INC, SRTL2K2RM1U WNC/INC

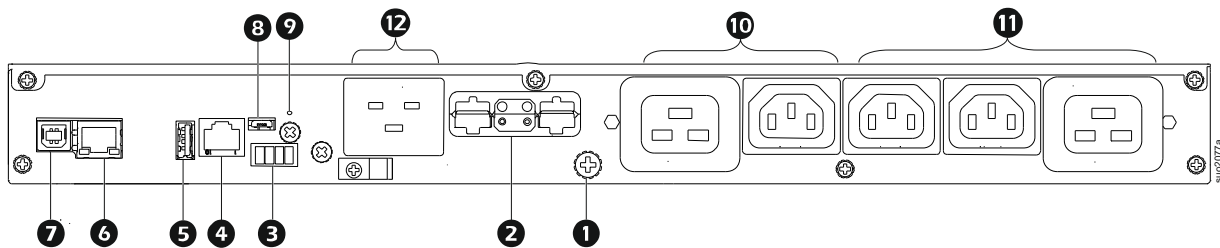

## SRTL3KRM1U WC/IC, SRTL2K2RM1U WC/IC

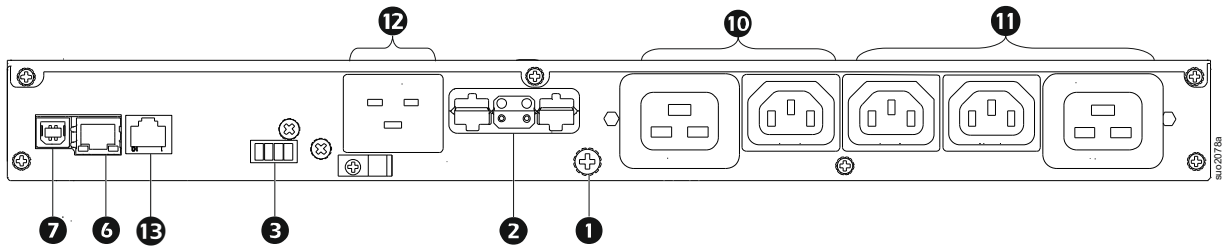

### Key to identify rear panel features

①	<b>Chassis Ground Screw</b>	The UPS and XLBPs have ground screws for connecting the ground leads. Prior to connecting a ground lead, disconnect the UPS from mains power.
②	<b>External battery connector receptacle (power and communication)</b>	Use the external battery cable on the XLBP to connect the UPS and XLBP. XLBPs provide extended runtime during power outages. The UPS will automatically recognize up to 5 external battery packs. <b>NOTE:</b> A CAN bus terminator is installed in this receptacle before shipping the UPS from the factory. While connecting an XLBP, remove the CAN bus terminator from the UPS and install it in the battery connector receptacle in the XLBP. Refer to the XLBP installation manual for detailed instructions.
③	<b>EPO terminal</b>	The Emergency Power Off (EPO) terminal allows the user to connect the UPS to a central EPO system.
④	<b>Universal I/O port</b>	Connect temperature sensors, temperature/humidity sensors, and relay input/output accessory connectors to this port.
⑤	<b>USB port</b>	Support for NMC and UPS firmware updates and the optional APC USB Wi-Fi Device (AP9834).
⑥	<b>Ethernet port</b>	Embedded Ethernet for <ul style="list-style-type: none"> <li>• SmartConnect (UC models)</li> <li>• NMC 3 (UNC models)</li> </ul>
⑦	<b>Data port</b>	The Data port is used to connect either a server for native operating system communications, or for software to communicate with the UPS.
⑧	<b>Micro USB port</b>	This is an NMC console port. Connect the NMC to a local computer, using a micro-USB cable (APC part number 960-0603), to configure initial network settings or access the command line interface (CLI).
⑨	<b>RESET button</b>	Press this button to Restart the network management interface. <b>NOTE:</b> This does not affect the output of the UPS.
⑩	<b>Main outlet group</b>	Connect electronic devices to the main outlet.
⑪	<b>Switched outlet group</b>	Connect electronic devices to these outlets.
⑫	<b>UPS Input</b>	Connect electronic devices to the input.
⑬	<b>Serial port</b>	The Serial port is used to communicate with the UPS. <b>Use only interface kits supplied or approved by APC by Schneider Electric. Any other serial interface cable will be incompatible with the UPS connector.</b>

# Installation

## Rack Installation

### CAUTION

#### RISK OF FALLING EQUIPMENT

- The equipment is heavy. Always practice safe lifting techniques adequate for the weight of the equipment.
- Always use the recommended number of screws to secure brackets to the UPS.
- Always use the recommended number of screws and cage nuts to secure the UPS to the rack.
- Always install the UPS at the bottom of the rack.
- Always install the external battery pack below the UPS in the rack.

Failure to follow these instructions can result in equipment damage and minor or moderate injury.

### 4 post rack mounting

Refer to the Rail Kit Installation Guide for instructions on rail installation.

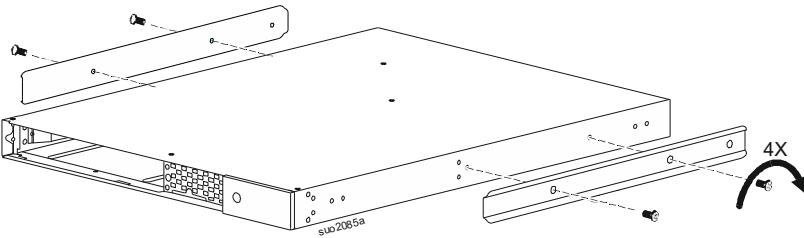
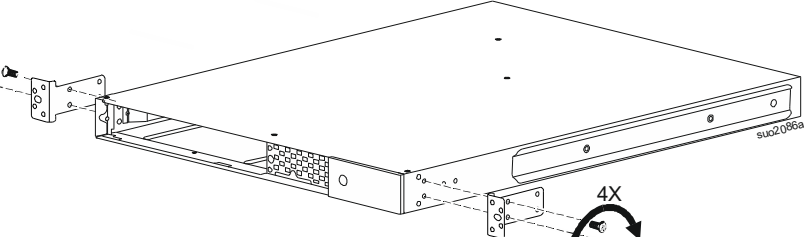
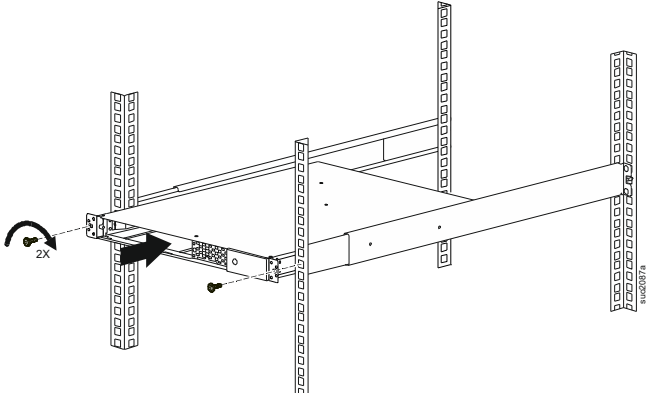
<b>1</b>	Install the cleats to the UPS.	
<b>2</b>	Install the rack-mount brackets to the UPS.	
<b>3</b>	Install the UPS to the 4 post rack.	

**5** Install the RBM in the UPS.

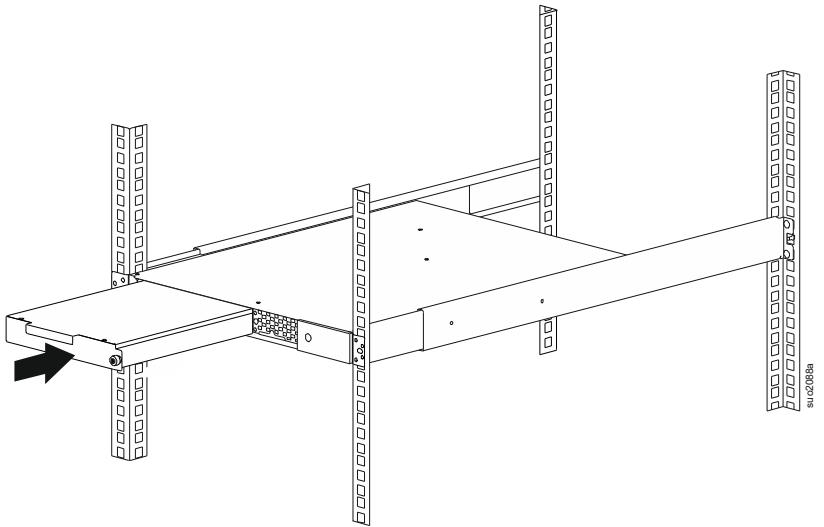

**6** Tighten the RBM thumbscrew.

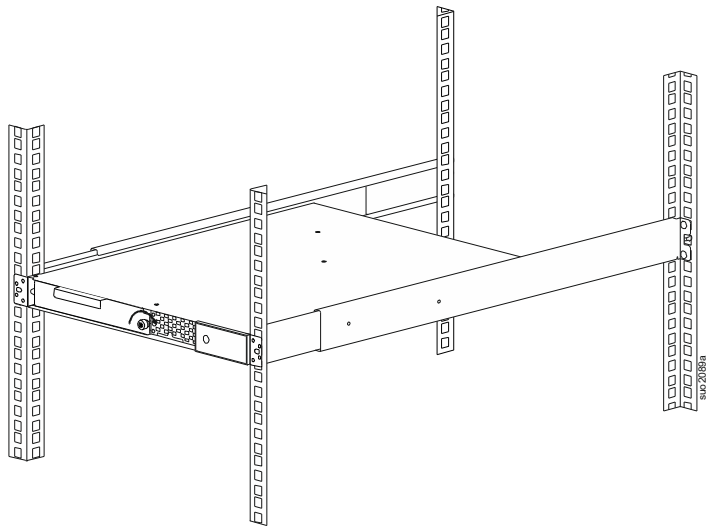

**7** Install the front bezel.

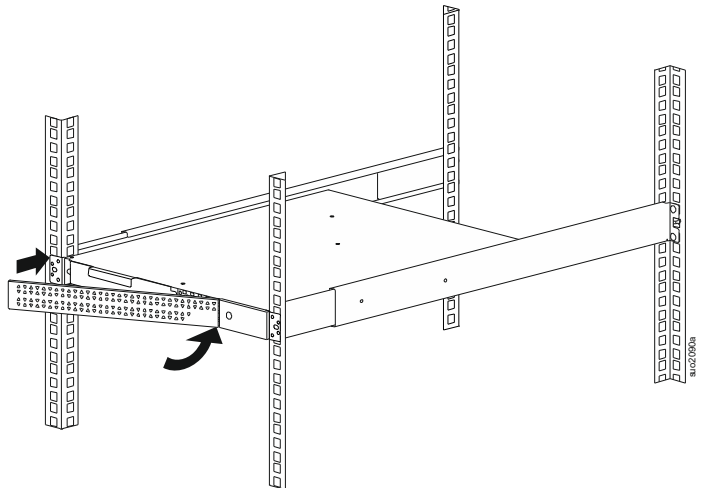

## 2 post rack-mounting

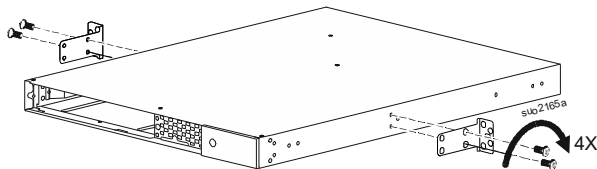
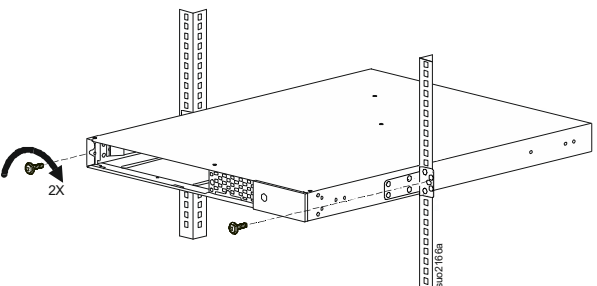
1	Install the rack-mount brackets to the UPS.	
2	Install the UPS to the 2 post rack.	
3	Install the RBM as per steps 5 and 6 in “4 post rack mounting” on page 10.	
4	Install the front bezel as per step 7 in “4 post rack mounting” on page 10.	

## Tower Installation

### CAUTION

#### RISK OF FALLING EQUIPMENT

- The equipment is heavy.
- Always practice safe lifting techniques adequate for the weight of the equipment.

**Failure to follow these instructions can result in equipment damage and minor or moderate injury.**

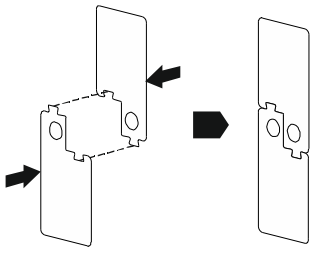
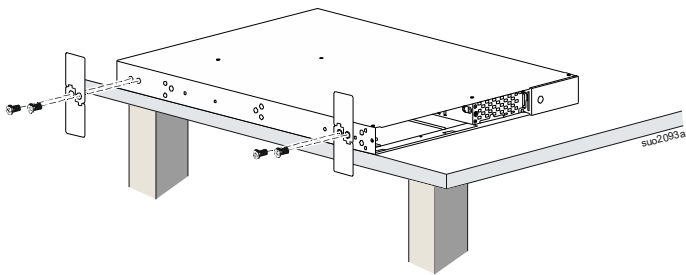
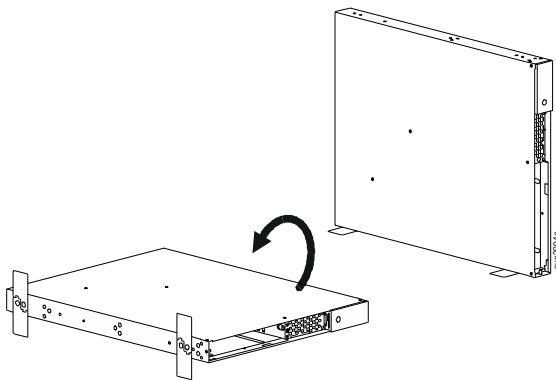
1	Assemble the foot stabilizers.	2	Install the stabilizers on the UPS.
			
3			
4	Install the RBM as per steps 5 and 6 in “4 post rack mounting” on page 10.		
5	Install the front bezel as per step 7 in “4 post rack mounting” on page 10.		

# Wall Installation

## CAUTION

### RISK OF FALLING EQUIPMENT

- The equipment is heavy.
- Always practice safe lifting techniques adequate for the weight of the equipment.

**Failure to follow these instructions can result in equipment damage and minor or moderate injury.**

- 1** Install the rack-mount brackets to the UPS.

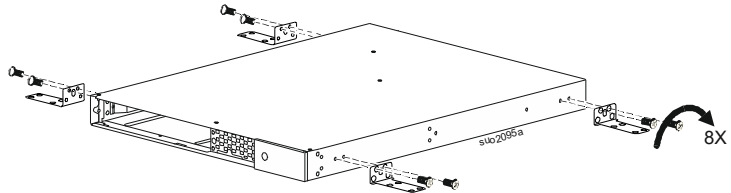

**2**

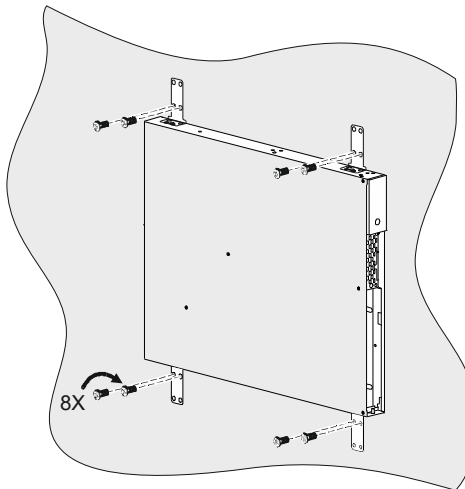

- 3** Install the RBM as per steps **5** and **6** in “4 post rack mounting” on page 10.

- 4** Install the front bezel as per step **7** in “4 post rack mounting” on page 10.

# Operation

## Connect Equipment and Input Power

### CAUTION

#### RISK OF ELECTRIC SHOCK

- Disconnect the mains input circuit breaker before installing or servicing the UPS or connected equipment.
- Disconnect internal RBM and XLBPs before installing or servicing the UPS or connected equipment.
- The UPS contains internal RBM and XLBPs that may present a shock hazard even when disconnected from the mains.
- UPS AC hardwired and pluggable outlets may be energized by remote or automatic control at any time.
- Disconnect equipment from the UPS before servicing any equipment.
- Do not use the UPS as a safety disconnect.

**Failure to follow these instructions can result in minor or moderate injury.**

**Note:** The UPS RBM will charge to 90% capacity in the first 1.5 hours of normal operation. **Do not expect full battery runtime capability during this initial charge period.**

1. Connect equipment to the outlets on the rear panel of the UPS.  
Refer to “Controllable Outlet Groups” on page 23.
2. Connect the UPS to the building utility power.

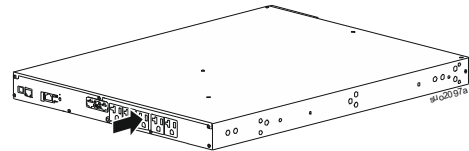

## Turn the UPS On/Off

The first time the UPS is turned on the **Setup Wizard** screen will run. Follow the prompts to configure UPS settings. Refer to “Configuration” on page 18.

To turn on the UPS and all connected equipment, touch the **POWER** button on the display panel. Follow the prompts to either turn the UPS on immediately or after a delay, then touch the **OK** button.

**NOTE:** When there is no input power and the UPS is off, the cold start feature can be used to turn on the UPS and connected equipment using battery power.

To perform a cold start, touch the **POWER** button.

The display panel will illuminate.

To turn on the output power touch the **POWER** button again. Select the prompt to either *TurnOn-No Delay* or *TurnOn-Use Delay*, then touch the **OK** button.

To turn output power off, touch the **POWER** button. Follow the prompts to either turn the UPS off immediately or after a delay, then touch the **OK** button.

**NOTE:** Once the UPS output power has been turned off and the AC input has been disconnected, the UPS will continue to use the battery for internal power for 10 minutes. To remove power completely touch the **POWER** button. Follow the prompt to select *Internal Power Off*, then touch the **OK** button.

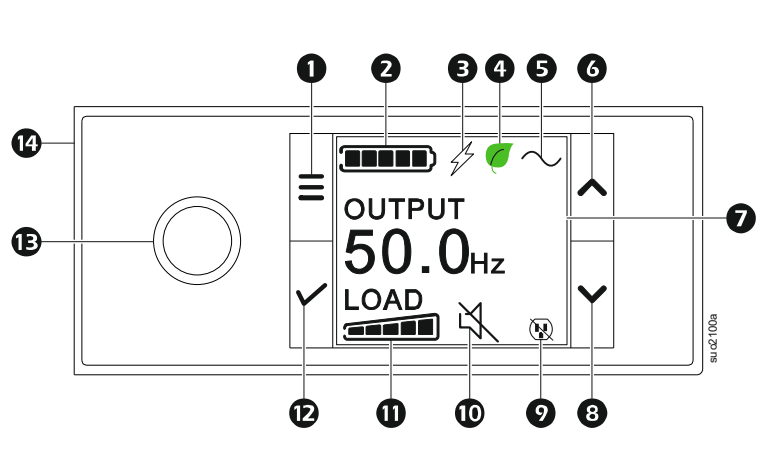

# UPS Display Interface

①	<b>MENU/ESCAPE button</b>	
②	<b>Battery capacity icon</b>	
③	<b>Battery charging icon</b>	
④	<b>Green mode icon</b>	
⑤	<b>Operation mode icon</b>	
⑥	<b>UP button</b>	
⑦	<b>UPS status information</b>	
⑧	<b>DOWN button</b>	
⑨	<b>controllable outlet group status icon</b>	
⑩	<b>Mute icon</b>	
⑪	<b>Load icon</b>	
⑫	<b>OK button</b>	
⑬	<b>POWER button with LED</b> <ul style="list-style-type: none"> <li>• Touch the button to wake up the UPS, when it is off state.</li> <li>• A short touch of the button will display the control menu. Follow the prompts on the screen to either turn the UPS <i>on/off</i> immediately or after a delay.</li> <li>• LED illumination indications are the same as the Status LED.</li> </ul>	
⑭	<b>Status LED</b> <ul style="list-style-type: none"> <li>• Not illuminated: UPS output is off.</li> <li>• Illuminates steady green: UPS is in on-line mode.</li> <li>• Flashes red every 2 seconds: UPS is in on-line status and battery is disconnected.</li> <li>• Illuminates amber: UPS is in battery mode.</li> <li>• Illuminates steady red: UPS has detected an internal error.</li> </ul>	



## UPS Display Interface operation

The UPS display interface is a touchscreen interface.

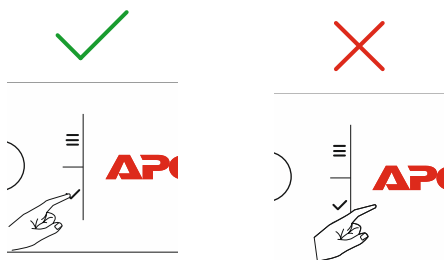
Touch on the icon to activate the key function.



Use the UP/DOWN buttons to scroll through the options. Touch the OK button to accept the selected option. Touch the ESC button to return to the previous menu.

The icons on the LCD display interface screen may vary depending on the installed firmware versions and specific UPS models.	
	<b>Load icon:</b> The approximate load capacity percentage is indicated by the number of load bar sections illuminated. Each bar represents 20% of the load capacity.
	<b>Mute icon:</b> Indicates the audible alarm is disabled/muted.

### UPS Status Information

The status information field provides key information on the status of the UPS.











The menu will allow the user to select one of the five screens listed below or scroll through the five screens automatically.

Use the UP/DOWN buttons to scroll through the screens.

- **Input Voltage**
- **Output Voltage**
- **Output Frequency**
- **Load**
- **Runtime**

In the case of a UPS event, status updates will be displayed defining the event or condition that has occurred.

The display screen illuminates amber to indicate an alert and red to indicate an alarm depending on the severity of the event or condition.

Operation Mode Icons	
	<b>Output Off:</b> The UPS isn't supplying power to connected equipment.
	<b>Battery mode:</b> The UPS is supplying battery power to connected equipment.
	<b>On-Line mode:</b> The UPS is supplying conditioned mains power to connected equipment.
	<b>Bypass mode:</b> The UPS is in Bypass mode and the connected equipment will receive mains power as long as the input voltage and frequency are within the configured limits.
Green mode Icon	
	<b>Green mode:</b> When in Green mode mains power is sent directly to the load. When enabling Green mode consideration should be given to devices that may be sensitive to power fluctuations.
Controllable Outlet Group Icons	
	Controllable outlet group - output <i>on</i> .
	Controllable Outlet Group - output <i>off</i> .
Battery Status Icons	
	<b>Battery charge status:</b> Indicates the battery charge status.
	<b>Battery disconnected icon:</b> Flashes to indicate that the UPS has detected that the battery is disconnected.
	<b>Battery charge in progress:</b> Indicates the battery is charging.

## LCD display interface angle adjustment

The orientation of the LCD display interface gets adjusted automatically based on UPS orientation.

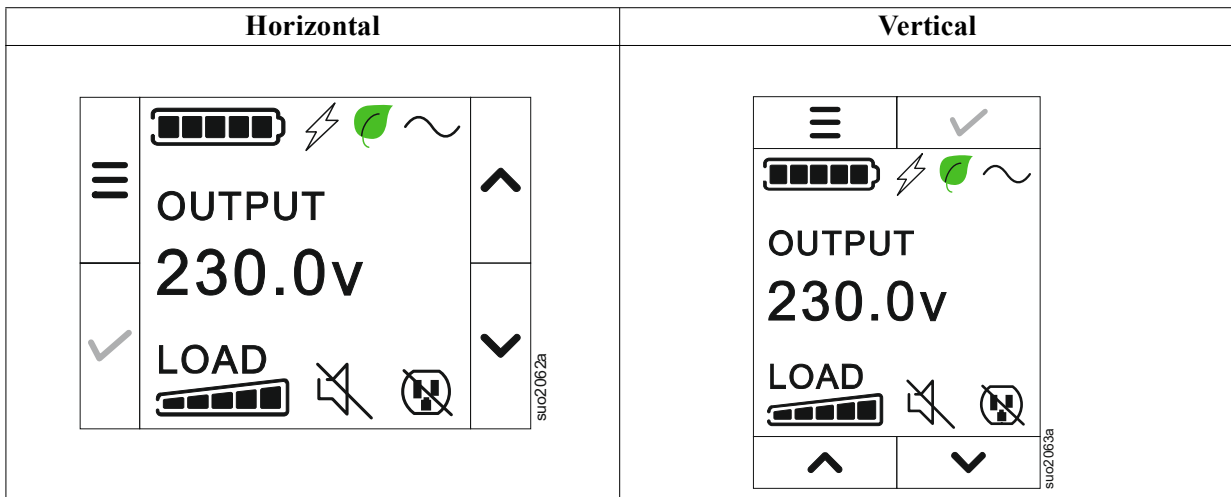

## Menu overview

The UPS Display Interface has **Standard** and **Advanced** menu screens. The preference for **Standard** or **Advanced** menu selections is made during initial installation and can be changed at any time through the **Configuration** menu.

The **Standard** menus include the most commonly used options.

The **Advanced** menus provide additional options.

**NOTE:** Actual menu screens may differ by model and firmware version.

# UPS Menu Overview

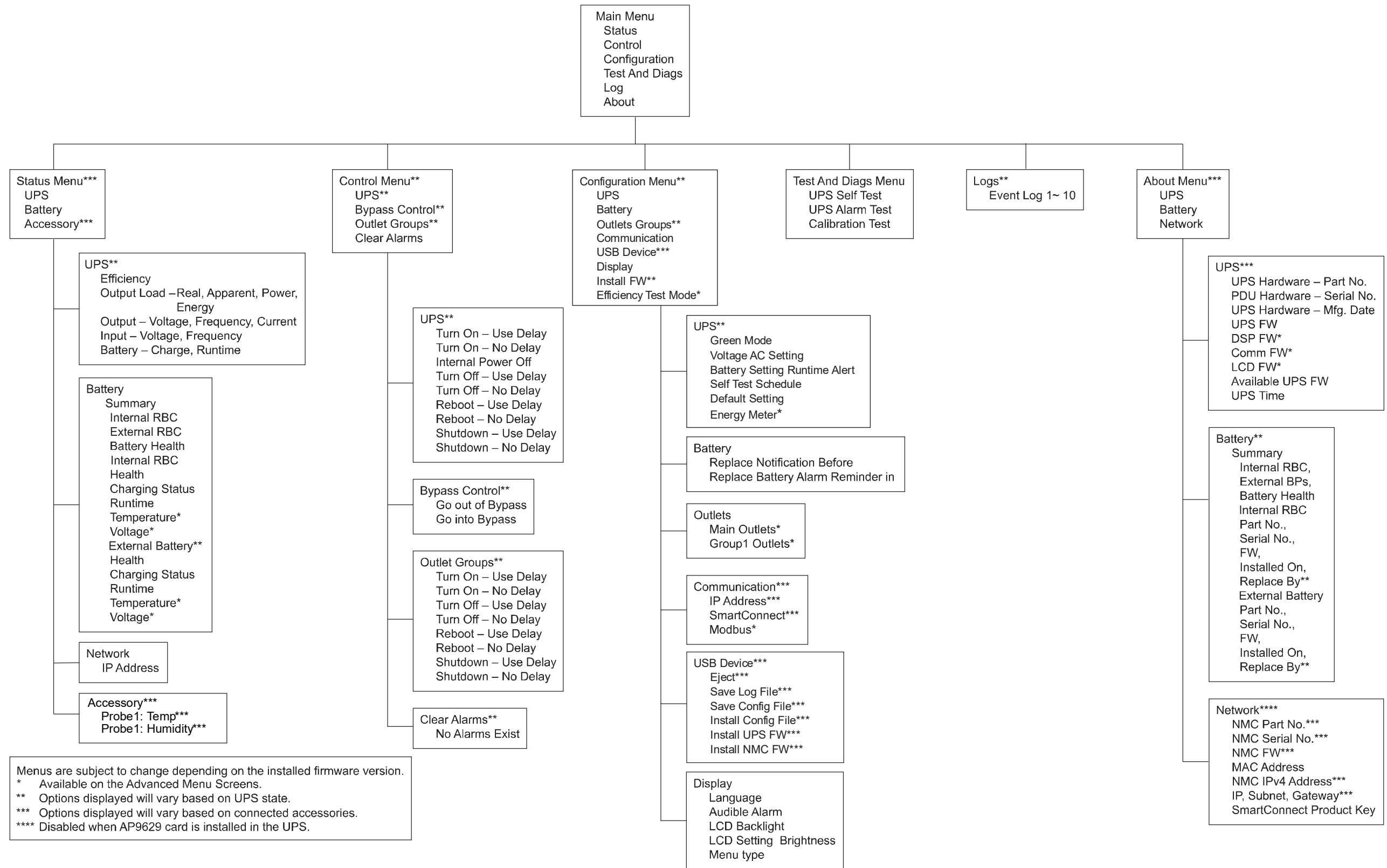

# Configuration

## UPS Settings

There are three ways to select UPS configuration options.

1. The first time the UPS is turned on the **Setup Wizard** screen will open. On each menu screen select the desired settings. Touch OK after each UPS setting is selected.

**NOTE:** The UPS will not turn on until all of the settings have been configured.

2. **Main Menu/Configuration/UPS/Default Setting.** This screen allows the user to reset the UPS to factory default settings. Touch the OK button after the UPS setting is selected. Refer to “Configuration” on page 18 and “UPS Menu Overview”.
3. Configure settings using an external interface, such as the Network Management Web interface.

## Startup configuration

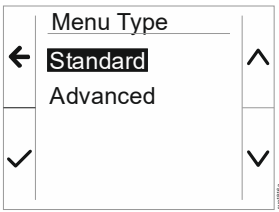
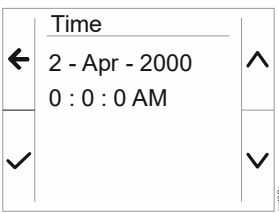
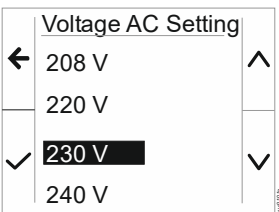
Function	Description
	<p>Select the language required for the display interface.</p> <p>Language options will vary by model and firmware version.</p> <p>Options:</p> <ul style="list-style-type: none"> <li>• English</li> <li>• Français</li> <li>• Italiano</li> <li>• Deutsch</li> <li>• Espanol</li> <li>• Portuguese</li> <li>• Japanese</li> <li>• Russian</li> </ul>
	<p>The <b>Standard</b> menu options are the most commonly used options.</p> <p>The <b>Advanced</b> menu options will be used by IT professionals who need detailed configuration and reporting information.</p>
	<p>The <b>time</b> menu option allows the user to set the date and time.</p>
	<p>Select the output voltage.</p> <p><b>NOTE:</b> Options will vary by model, the cursor will stay on the actual output value.</p> <p>Options:</p> <ul style="list-style-type: none"> <li>• 208 VAC</li> <li>• 220 VAC</li> <li>• 230 VAC</li> <li>• 240 VAC</li> </ul>

## General settings

Configure these settings at any time, using the display interface, or the Network Management Web Interface.

	Parameters	Default Value	Options	Description
Configuration Menu UPS	Green Mode	Disabled	<ul style="list-style-type: none"> <li>• Disable</li> <li>• Enable</li> </ul>	Disable or enable <b>Green</b> mode operation.
	Battery Setting Runtime Alert	150 seconds	0 to 1800 seconds	The UPS will emit an audible alarm when the remaining runtime has reached this threshold.
	Self Test Sch.	Startup + 14d Since	<ul style="list-style-type: none"> <li>• Never</li> <li>• Startup</li> <li>• Startup + 7d Since</li> <li>• Startup + 14d Since</li> </ul>	This is the interval at which the UPS will execute a <b>Self Test</b> .
	Default Setting	No	<ul style="list-style-type: none"> <li>• Yes</li> <li>• No</li> </ul>	Allows the user to restore the UPS factory default settings.
	Energy Meter	No	<ul style="list-style-type: none"> <li>• Yes</li> <li>• No</li> </ul>	The Energy Meter stores information on UPS output energy usage. The Reset feature allows the user to reset the Energy Meter to 0 kWh.
Configuration Menu Battery	Replacement Notification Time	183 days	<ul style="list-style-type: none"> <li>• 0-360 days</li> <li>• -1</li> </ul>	To set the <b>Near End of Life</b> alarm, select the number of days before the estimated battery end of life. When this date is reached the UPS will emit an audible alarm and a message will appear on the display interface screen. Example: Using the default value, the <b>Near End of Life</b> alarm will occur 183 days before the estimated end of life date. To disable the notifications select - 1.
	Replacement Battery Alarm Reminder	14 days	<ul style="list-style-type: none"> <li>• 0-180 days</li> <li>• -1</li> </ul>	The <b>Near End of Life</b> audible alarm can be muted. Enter the number of days between the time a <b>Near End of Life</b> alarm is acknowledged and the next <b>Near End of Life</b> alarm occurs. To disable the notifications select - 1.
Configuration Menu Outlet Groups Main Outlets	Power On Delay	0 seconds	0-1800 seconds	Select the amount of time the main outlet group will wait between receiving the command to turn on and actual startup.
	Power Off Delay	0 seconds	0-32767 seconds	Select the amount of time the main outlet group will wait between receiving the command to shutdown and actual shutdown.
	Reboot Duration	8 seconds	4-300 seconds	Select the amount of time the main outlet group will remain off before the UPS will restart.
	Min Return Runtime	0 seconds	0-32767 seconds	Select the amount of battery runtime that must be available before the main outlet group will turn on using battery power, after a shutdown.
	LoadShed Time On Batt	Disable	<ul style="list-style-type: none"> <li>• Disable</li> <li>• Enable</li> </ul>	To conserve battery power the UPS can disconnect power from main outlet group not in use.
	LoadShed Time On Batt Setting	5 seconds	5-32767 seconds	Select the amount of time the main outlet group will be allowed to function on battery power before shutdown. <b>NOTE:</b> This setting is configurable only when "LoadShed Time On Batt" is set to "Enable".
	LoadShed Runtime Remaining	Disable	<ul style="list-style-type: none"> <li>• Disable</li> <li>• Enable</li> </ul>	To conserve battery power the UPS can disconnect power from main outlet group when the Loadshed Runtime threshold is reached.
	LoadShed Runtime Remaining Setting	0 seconds	0-3600 seconds	When the selected runtime threshold is reached the UPS will shutdown the main outlet group. <b>NOTE:</b> This setting is configurable only when "LoadShed Runtime Remaining" is set to "Enable".

	Parameters	Default Value	Options	Description
<b>Configuration Menu</b> <b>Outlet Groups</b> <b>Group 1</b> <b>Outlets</b>	<b>Power On Delay</b>	0 seconds	0-1800 seconds	Select the amount of time the controllable outlet groups will wait between receiving the command to turn on and actual startup.
	<b>Power Off Delay</b>	90 seconds	0-32767 seconds	Select the amount of time the controllable outlet groups will wait between receiving the command to shutdown and actual shutdown.
	<b>Reboot Duration</b>	8 seconds	4-300 seconds	Select the amount of time the controllable outlet groups will remain off before the UPS will restart.
<b>Configuration Menu</b> <b>Outlet Groups</b> <b>Group 1</b> <b>Outlets</b>	<b>Minimum Return Runtime</b>	0 seconds	0-32767 seconds	Select the amount of battery runtime that must be available before the controllable outlet groups will turn on using battery power, after a shutdown.
	<b>LoadShed Time On Battery</b>	Disable	<ul style="list-style-type: none"> <li>• Disable</li> <li>• Enable</li> </ul>	To conserve battery power the UPS can disconnect power from controllable outlet groups not in use.
	<b>LoadShed Time On Battery Setting</b>	5 seconds	5-32767 seconds	Select the amount of time the controllable outlet groups will be allowed to function on battery power before shutdown. <b>NOTE:</b> This setting is configurable only when "LoadShed Time On Battery" is set to "Enable".
	<b>LoadShed Runtime Remaining</b>	Disable	<ul style="list-style-type: none"> <li>• Disable</li> <li>• Enable</li> </ul>	To conserve battery power the UPS can disconnect power from controllable outlet groups when the <b>Loadshed Runtime</b> threshold is reached.
	<b>LoadShed Runtime Remaining Setting</b>	0 seconds	0-3600 seconds	When the selected runtime threshold is reached the UPS will shutdown the controllable outlet groups. <b>NOTE:</b> This setting is configurable only when "LoadShed Runtime Remaining" is set to "Enable".
	<b>LoadShed On Overload</b>	Disable	<ul style="list-style-type: none"> <li>• Disable</li> <li>• Enable</li> </ul>	To conserve energy in the event of an overload condition greater than 105% output, the controllable outlet groups will immediately turn off. The controllable outlet groups will only turn on again with a manual restart command once the overload condition has been corrected.
<b>Configuration Menu</b> <b>Communication</b>	<b>IP Address Mode</b>	DHCP	<ul style="list-style-type: none"> <li>• Manual,</li> <li>• DHCP,</li> <li>• BOOTP</li> </ul>	Selects the IP address configuration mode of UPS embedded SmartConnect port or Network Management Card (depends on SKU): <ul style="list-style-type: none"> <li>• Manual: Assign a static IPv4 address to UPS manually.</li> <li>• DHCP: UPS will automatically configure its IPv4 address via DHCP protocol.</li> <li>• BOOTP: UPS will automatically configure its IPv4 address via BOOTP protocol.</li> </ul> <b>NOTE:</b> This feature is available in SRTL3KRM1U WNC/INC and SRTL2K2RM1U WNC/INC models only.

	Parameters	Default Value	Options	Description
<b>Configuration Menu Communication</b>	<b>IPv4 Address Setting</b>	<ul style="list-style-type: none"> <li>• IP Address: 0.0.0.0</li> <li>• Subnet Mask: 0.0.0.0</li> <li>• Default Gateway: 0.0.0.0</li> </ul>		<p><b>NOTE:</b> This setting is only configurable when IP “Address Mode” is set to “Manual”.</p> <ul style="list-style-type: none"> <li>• IP Address Setting: This is the IPv4 address assigned to the Ethernet port.</li> <li>• Subnet Mask: Assigns the subnet mask of the network where UPS IPv4 address belongs.</li> <li>• Default Gateway: This is the IPv4 address of the host from where the UPS sends data to another network or Internet.</li> </ul>
	<b>DNS Server1</b>	000.000.000.000	A valid IPv4 address	The IPv4 address of first domain name server (DNS) the UPS uses to resolve host names to IPv4 addresses. When <b>DHCP</b> IP address mode is selected, it will display the IPv4 address of the first DNS server assigned by DHCP server. When <b>Manual</b> IP address mode is selected, you need to manually specify the IPv4 address of the first DNS server.
	<b>DNS Server2</b>	000.000.000.000	A valid IPv4 address	The IPv4 address of second domain name server (DNS) the UPS uses to resolve host names to IPv4 addresses (only when UPS is not able to resolve the IP address through first domain name server). This setting is optional. When <b>DHCP</b> IP address mode is selected, it will display the IPv4 address of the second DNS server assigned by DHCP server. When <b>Manual</b> IP address mode is selected, you can manually specify the IPv4 address of the second DNS server or leave it as 000.000.000.000.
	<b>Smart Connect (for NC models only)</b>	Enable-No Ctrl	<ul style="list-style-type: none"> <li>• Enable-No Ctrl</li> <li>• Enable-with Ctrl</li> <li>• Disable</li> </ul>	<p>Disable: Cloud connection via the embedded network interface (LCE) is not allowed. Enable-with Ctrl / Enable-No Ctrl: Allow commands from the “cloud” or not.</p>
	<b>Smart Connect Restart</b>	No	<ul style="list-style-type: none"> <li>• No</li> <li>• Yes</li> </ul>	Allows the user to restart smart connect.
	<b>Modbus ID</b>	1	1 - 223	Allows the user to select the Modbus address.
	<b>Modbus Serial</b>	Disable	<ul style="list-style-type: none"> <li>• Enable</li> <li>• Disable</li> </ul>	Enables or disables UPS Modbus protocol over serial port.
	<b>Modbus USB</b>	Disable	<ul style="list-style-type: none"> <li>• Enable</li> <li>• Disable</li> </ul>	Enables or disables UPS Modbus protocol over USB port.



	Parameters	Default Value	Options	Description
<b>Configuration Menu</b> <b>Communication</b>	<b>Modbus TCP Protocol</b>	Disable	<ul style="list-style-type: none"> <li>• Disable</li> <li>• Read-Only</li> <li>• Read-Write</li> </ul>	<p>Enables or disables UPS Modbus TCP/IP protocol provided by the embedded SmartConnect port.</p> <ul style="list-style-type: none"> <li>• <b>Disable:</b> Disables UPS Modbus TCP/IP protocol.</li> <li>• <b>Read-Only:</b> Modbus master over TCP/IP protocol is only allowed to get UPS status.</li> <li>• <b>Read-Write:</b> Modbus master over TCP/IP protocol is allowed to get UPS status and control the UPS. The port number of UPS Modbus TCP/IP protocol is fixed at 502.</li> </ul> <p><b>CAUTION:</b> MODBUS TCP/IP protocol poses a security risk. The UPS helps only providing protection by limiting the connection from the IP address specified by “Modbus Master IP address”. It is recommended to connect the UPS to a secured network protected by firewall.</p>
	<b>Modbus Master IP Address</b>	000.000.000.000	A valid IPv4 address	<p>Specifies the IPv4 address of the Modbus master. The Master IP Addr when set as 000.000.000.000 will allow connection of external Modbus master with any IP address. When not set as 000.000.000.000, only the Modbus master with the specified IP address is allowed to connect to the UPS.</p> <p>Example: Master IP Address is set to 192.168.0.10, only Modbus master with IP address 192.168.0.10 can connect to the UPS.</p>
<b>Configuration Menu</b> <b>USB Device</b>	<b>Eject</b>	No	<ul style="list-style-type: none"> <li>• No</li> <li>• Yes</li> </ul>	Eject the currently inserted USB device.
	<b>Save Log File</b>	No	<ul style="list-style-type: none"> <li>• No</li> <li>• Yes</li> </ul>	Save the log of the UPS.
	<b>Save Config file</b>	No	<ul style="list-style-type: none"> <li>• No</li> <li>• Yes</li> </ul>	Save the config parameters of the NMC.
	<b>Install Config</b>	No	<ul style="list-style-type: none"> <li>• No</li> <li>• Yes</li> </ul>	Install the NMC config parameters saved in the USB device.
	<b>Install UPS FW</b>	No	<ul style="list-style-type: none"> <li>• No</li> <li>• Yes</li> </ul>	This menu is automatically displayed when it is detected that the USB device has valid UPS firmware sufficient to upgrade.
	<b>Install NMC FW</b>	No	<ul style="list-style-type: none"> <li>• No</li> <li>• Yes</li> </ul>	Supports NMC firmware upgrade via USB device. This menu will be displayed when the USB device is detected with valid firmware of NMC.
<b>Configuration Menu</b> <b>Display</b>	<b>Language</b>	English	<ul style="list-style-type: none"> <li>• English</li> <li>• Francais</li> <li>• Italiano</li> <li>• Deutsch</li> <li>• Espanol</li> <li>• Portugues</li> <li>• Japanese</li> <li>• Russian</li> </ul>	<p>Select the language required for the display interface.</p> <p>Language options will vary by model and firmware version.</p>
	<b>Audible Alarm</b>	Enable	<ul style="list-style-type: none"> <li>• Disable</li> <li>• Enable</li> </ul>	When audible alarms are disabled, the UPS will never emit an audible alarm.
	<b>LCD Back Light</b>	Auto Dim	<ul style="list-style-type: none"> <li>• Always On</li> <li>• Auto Dim</li> <li>• Auto Off</li> </ul>	To conserve energy, the LCD back light illumination dims or turns off when no events are active. Full display interface illumination returns when the UPS changes status as a result of an event or when any button on the display interface is touched.
	<b>LCD Setting Brightness</b>	High	<ul style="list-style-type: none"> <li>• Low</li> <li>• Medium</li> <li>• High</li> <li>• Maximum</li> </ul>	Adjust the brightness for LCD back light.
	<b>Menu Type</b>	User Choice	<ul style="list-style-type: none"> <li>• Standard</li> <li>• Advanced</li> </ul>	<p>The <b>Standard</b> menus include the most commonly used options.</p> <p>The <b>Advanced</b> menu options include all parameters.</p>

# Controllable Outlet Groups

---

Controllable Outlet Groups provide battery backup power to connected equipment.

## Overview

The controllable outlet groups can be configured using the Advanced menu options. Refer to “General settings” on page 19.

The controllable outlet groups can be configured to independently *turn off*, *turn on*, *shutdown*, *switch to sleep mode*, and *reboot connected equipment*.

- **Turn Off:** Disconnect output power to connected equipment either immediately using the **TurnOff Immediately** feature or after a configured delay using the **TurnOff With Delay** feature.  
**NOTE:** Controllable outlet groups can be turned on only using the **TurnOn** feature.
- **Turn On:** Connect output power to connected equipment either immediately using the **TurnOn Immediately** feature or after a configured delay using the **TurnOn With Delay** feature.
- **Shutdown:** Disconnects the power to connected equipment either immediately or after a configured delay. Equipment reconnects after a configured delay when mains power becomes available and other configured conditions are met.
- **Reboot:** Disconnect the power to connected equipment either immediately or after a configured delay. Reconnect equipment after a configured delay when either mains or battery power becomes available and other configured conditions are met.
- **Sleep:** This mode is a reboot with an extended duration where an outlet(s) remains turned off. Disconnect the power to connected equipment either immediately or after a configured delay. Reconnect equipment after a configured delay when either mains or battery power becomes available and other configured conditions are met.  
Each controllable outlet group can be configured separately to allow power sequencing for equipment connected to any controllable outlet group.  
To configure Sleep mode use an external interface, such as the Network Management Web interface.
- **Automatically turn off or shutdown** when certain conditions occur, based on user configurations set using the Config Menu Outlets menus. Refer to “Configuration” on page 18.

## Connect controllable outlet groups

- Connect essential equipment to main outlet.
- Connect peripheral equipment to controllable outlet groups.
  - To conserve battery runtime during a power outage, nonessential equipment can be configured to shut down. Use **Loadshed Time on Battery Enable/Disable** and **Loadshed Time on Battery Setting** defined in the General Settings section. Refer to “General settings” on page 19.
  - If equipment has dependent peripherals that must restart or shut down in a specific sequence, such as an ethernet switch that must restart before a connected server can be restarted, connect the devices to different outlet groups.
  - Use the **Configuration** menu to configure how the controllable outlet groups will react in the event of a power outage.

# Emergency Power Off

## Overview

The Emergency Power Off (EPO) option is a feature that will immediately disconnect all connected equipment from mains power. The UPS will immediately shut down and will not switch to battery power.

Connect each UPS to the EPO switch. If multiple units are to be controlled with an EPO switch, each UPS must be connected separately to the EPO switch.

The UPS must be restarted for power to return to connected equipment. Touch the POWER button on the front panel of the UPS.

## Normally open contacts

1. If the EPO switch or relay contacts are normally open, insert the wires from the switch or contacts at pins 1 and 2 of the EPO terminal block. Use 16-28 AWG wire.
2. Secure the wires by tightening the screws.

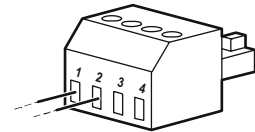

If the contacts are closed, the UPS will turn OFF and power will be removed from the load.

## Normally closed contacts

1. If the EPO switch or relay contacts are normally closed, insert the wires from the switch or contacts at pins 2 and 3 of the EPO terminal block. Use 16-28 AWG wire.
2. Insert a wire jumper between pins 1 and 2. Secure the wires by tightening the three screws at positions 1, 2, and 3.

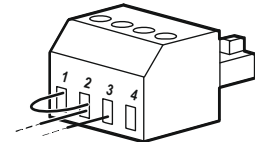

If the contacts are opened, the UPS will turn OFF and power will be removed from the load.

**NOTE:** Pin 1 is the power source for the EPO circuit, it provides a few milliamperes of 24 V power.

If the normally closed (NC) EPO configuration is used, the EPO switch or relay should be rated for “dry” circuit applications, the rating should be for low voltage and low current applications. This normally implies the contacts are gold plated.

The EPO interface is a Safety Extra Low Voltage (SELV) circuit. Connect the EPO interface only to other SELV circuits. The EPO interface monitors circuits that have no determined voltage potential. SELV circuits are controlled by a switch or relay properly isolated from mains power. To avoid damage to the UPS, do not connect the EPO interface to any circuit other than a SELV circuit.

Use one of the following cable types to connect the UPS to the EPO switch.

- CL2: Class 2 cable for general use.
- CL2P: Plenum cable for use in ducts, plenums, and other spaces used for environmental air.
- CL2R: Riser cable for use in a vertical run in a floor to floor shaft.
- CLEX: Limited use cable for use in dwellings and for use in raceways.
- Installation in Canada: Use only CSA certified, type ELC, (extra low voltage control cable).
- Installation in countries other than Canada and the USA: Use standard low voltage cable in accordance with national and local regulations.

# Network Management Interface

**NOTE: This feature is available only in SRT3KRM1UNC and SRT2K2RM1UNC models.**

## Introduction

The UPS has a network port and console port that can be used to access the Network Management Interface.

The Network Management Interface have the same firmware, operation modes and interaction with other APC products such as PowerChute Network Shutdown.

## Features

The Network Management Interface allows the UPS to function as a Web based, IPv6 ready product.

The Network Management Interface can manage the UPS using multiple open standards such as:

Hypertext Transfer Protocol (HTTP)	Secure SHell (SSH)
Simple Network Management Protocol versions 1 and 3 (SNMPv1, SNMPv3)	Hypertext Transfer Protocol over Secure Sockets layer (HTTPS)
File Transfer Protocol (FTP)	Secure Copy (SCP)
Telnet	Syslog
RADIUS	



The Network Management Interface:

- Provides UPS control and **Self Test** scheduling features.
- Provides data and event logs.
- Enables you to set up notifications through event logging, e-mail, and SNMP traps.
- Provides support for PowerChute Network Shutdown.
- Supports using a Dynamic Host Configuration Protocol (DHCP) or BOOTstrap Protocol (BOOTP) server to provide the network (TCP/IP) values.
- Supports use of Remote Monitoring Service (RMS).
- Provides the ability to export a user configuration (.ini) file from a configured UPS, to one or more unconfigured UPS without conversion to a binary file.
- Provides a selection of security protocols for authentication and encryption.
- Communicates with StruxureWare Central and InfraStruxure Manager.
- Supports one universal input/output port for connection to a:
  - Temperature probe, AP9335T (optional)
  - Temperature/humidity sensor, AP335TH (optional)
  - Relay input/output connector that supports two input contacts and one output relay, AP9810 Dry Contact I/O Accessory (optional)

## Related Documents

For related documents refer our web site, [www.schneider-electric.com](http://www.schneider-electric.com).

## IP Address Configuration

The default TCP/IP configuration setting DHCP, assumes that a properly configured DHCP server is available to provide TCP/IP settings to the Network Management Interface.

If the Network Management Interface obtains an IPv4 address from a DHCP server, use the UPS Display Interface menus About → Network → NMC IPv4 Address, to see the address.

To setup a static IPv4 address use the UPS Display Interface Config menu. Set the IP address Subnet Mask and Gateway from the Config menu.

# Upgrade Firmware

The firmware of the UPS, Battery Module and XLBPs can be updated using web-interface, which is built into the UPS network management card. The encrypted image of each subsystem is combined into a single, digitally signed binary image, to provide an advance level of security and tamper proofing.

- Be sure that the Network Management Card is configured and connected to the network.
- Login to the web interface with a valid Username and password.
- Read the firmware upgrade release notes and be sure the compatibility of the new firmware image with the UPS model and the existing firmware version.
- Be sure that adequate battery backup is available before initiating the firmware update.
- Go to the Firmware update section in the web interface, select the valid signed binary image and initiate the update. It may take several minutes for the update(s) to be installed.
- Verify the firmware version in the About menu to be sure that the firmware update was successful.

# APC SmartConnect

---

**NOTE: This feature is available only in SRTL3KRM1U WC/IC, SRTL2K2RM1U WC/IC.**

APC SmartConnect allows you to monitor the health and status of your UPS from any device connected to the Internet. Visit [www.smartconnect.apc.com](http://www.smartconnect.apc.com) to learn more. Log onto [www.smartconnect.apc.com](http://www.smartconnect.apc.com) or scan the QR code to launch the registration process. The website includes instructions to setup your online account, activate your warranty and begin monitoring your UPS remotely.

By connecting this product to the Internet using the APC SmartConnect port, you are agreeing to APC SmartConnect Terms of Use, as found at [smartconnect.apc.com](http://smartconnect.apc.com). Schneider Electric Data Privacy Policy can also be found at [smartconnect.apc.com](http://smartconnect.apc.com).

# Physical Security

---

## Deploy the UPS in a secure location

- Custodians should secure the UPS from unauthorized physical access.
- Access should be restricted to only those who are authorized to maintain the UPS.
- Restricted areas should be clearly marked “For Authorized Personnel only”.
- Restricted areas should be secured by access controlled doors.
- Access to the restricted areas should produce either a physical or an electronic audit trail.

## Secure access to the UPS front panel and communication port

Deploy the UPS in a rack or an enclosure that can be locked or physically secured. This will prevent access to the physical ports of the devices.

# Smart Battery Management

---

## Definitions

- Replaceable Battery Module (RBM): A string of battery cells arranged to produce a battery assembly with a connector. RBMs can be ordered from our web site, [www.schneider-electric.com](http://www.schneider-electric.com).
- External Battery Pack (XLBP): An enclosure that contains batteries and battery management electronics. XLBPs can be ordered from our web site, [www.schneider-electric.com](http://www.schneider-electric.com).
- User Interface (UI): Any interface by which a user can interact with the system. This may include a UPS display interface, a network management interface or PowerChute™ Network Shutdown software.

**NOTE: Do not use a battery that is not approved by APC.**

**The system will not detect the presence of a non APC approved battery and may adversely affect the operation of the system.**

**Use of a non APC approved battery will void the manufacturer warranty.**

## Features

Smart Battery Management provides the following features:

- Monitors and informs the user of the health of each RBM and XLBP.
- Monitors and shows on the UPS Display Interface screen, the date for the end of useful life for each RBM and XLBP.
- The UPS emits an audible alarm and shows a message on the UPS Display Interface screen to indicate the estimated battery end of life. On the UPS Display Interface screen the user can set the number of days before the audible alarm is heard and the message appears on the UPS Display Interface screen.
- Automatically detects the addition or removal of XLBPs and RBM.
- Monitors the internal temperature of each RBM and XLBP and automatically adjusts the battery charging current.

## Maintenance

**NOTE:** Battery module does not support hot swap during discharging.

- **RBM maintenance:** The APC RBM uses Li-ion battery cells and does not require maintenance.
- **Battery health monitoring:** The battery energy output and voltage are monitored to assess the health of the installed batteries when the UPS is operating on battery.  
Battery health monitoring is done during a UPS **Self Test**, and when the UPS is operating on battery power. The UPS can be configured to perform periodic, automatic **Self Tests**.

## End of useful life

- **Near end of life notification:** An alert message will appear on the UPS display interface screen when each RBM is approaching the end of its useful life. For configuration details refer to **Replacement Notification Time** and **Replacement Battery Alarm Time**.  
The estimated replacement date for each RBM is available through the UI.
- **Needs replacement notification:** The UPS display interface screen shows when RBM replacement is required. The RBM must be replaced as soon as possible.  
When an RBM requires replacement, the UPS display interface may recommend that additional RBMs be replaced if they will soon reach the end of their useful life.

**NOTE: Continued operation after end of useful life notification may cause damage to the batteries.**

- **Recycling:** Remove the RBM from the UPS. Recycle the RBM. Do not disassemble the RBM.

## Replace the RBM in a UPS

**A RBM should only be disconnected or removed from the UPS temporarily as part of the battery replacement procedure.**

- Disconnect the connected RBM in the UPS. Slide the RBM out of the UPS.
- Slide the new RBM into the UPS and secure the RBM to the UPS.

- Securely connect the RBM. Press the RBM into the UPS until it is firmly connected and be sure that the RBM Thumbscrew is tightened completely.  
A RBM that is not properly connected will cause erratic UPS operation, abnormal alert messages and connected equipment may not receive battery power during power outages.
- After installing the RBM, the UPS display interface may prompt the user to verify the status of the replaced battery module.

## **Recommended actions after installing a new RBM**

- Verify that the UPS is connected to input power and the output power is turned on. See “Connect Equipment and Input Power” on page 14 for instructions.
- Perform a UPS **Self Test**.
- Allow the system to charge for 24 hours to ensure full runtime capability.

## **XLBP installation and replacement**

Refer to the XLBP Installation manual for installation and replacement instructions.

# Troubleshooting

Use the table below to solve minor installation and operation problems.

Refer to our web site, [www.schneider-electric.com](http://www.schneider-electric.com) for assistance with complex UPS problems.

The UPS features firmware that can be upgraded.

Go to our web site, [www.schneider-electric.com/Support](http://www.schneider-electric.com/Support), or contact your local Customer Care Center for more information.

Problem and Possible Cause	Solution
<b>UPS is not turning on or there is no output</b>	
The UPS is not connected to mains power.	Be sure the power cable is securely connected to the mains power supply.
The UPS display interface screen shows very low or no mains power.	Check the mains power supply to verify acceptable power quality.
There is an internal UPS alert or message.	The UPS Display Interface screen will show a message to identify the alert or message and corrective action.
<b>UPS emits an audible alarm</b>	
Normal UPS operation when running on battery power.	The UPS is operating on battery power. Refer to the status of the UPS as shown on the UPS Display Interface screen. Touch any key to mute all audible alarms.
The UPS emits an audible alarm and has a red or amber back light on the UPS Display Interface screen.	The UPS has detected an internal error. Refer to the display interface screen for information.
<b>UPS does not provide expected backup time</b>	
The battery charge is weak due to a recent power outage or they are near the end of service life.	Charge the batteries. Batteries require recharging after extended outages and wear out faster when put into service often or when operated at elevated temperatures. If the batteries are near the end of service life, consider replacing the batteries even if the <b>Replace Battery</b> message is not displayed.
The UPS is experiencing an overload condition.	The connected equipment exceeds the specified maximum load. Refer to our web site, <a href="http://www.schneider-electric.com">www.schneider-electric.com</a> for product specifications. The UPS will emit a sustained audible alarm until the overload condition is corrected. Disconnect nonessential equipment from the UPS to correct the overload condition.
<b>UPS operates on battery power while connected to mains power</b>	
The input circuit breaker has tripped.	Reduce the load on the UPS. Disconnect nonessential equipment and reset the circuit breaker. Check the circuit breaker rating for the connected equipment.
There is very high, very low, or distorted input line voltage.	Navigate to the UPS Display Interface screen that shows input voltage. Verify that the input voltage is within specified operating limits. If no input voltage is indicated on the UPS Display Interface screen, contact Customer Support through our web site, <a href="http://www.schneider-electric.com">www.schneider-electric.com</a> .
<b>UPS Display Interface Status screen shows Overload and the UPS emits a sustained audible alarm</b>	
The UPS is experiencing an overload condition.	The connected equipment exceeds the maximum load rating for the UPS. The UPS will emit a sustained audible alarm until the overload condition is corrected. Disconnect nonessential equipment from the UPS to correct the overload condition.
<b>UPS Display Interface Status screen shows UPS is operating in Bypass mode</b>	
The UPS received a command to operate in <b>Bypass</b> mode	No action is required.
The UPS has automatically switched to <b>Bypass</b> mode due to an internal UPS alert or message.	The UPS Display Interface screen will show a message to identify the alert or detected error and corrective action.

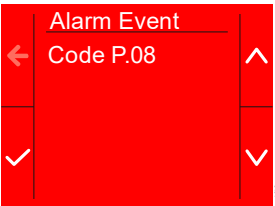
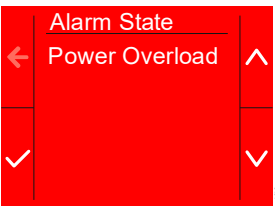

Problem and Possible Cause	Solution
<b>UPS Display Interface is red or amber and shows an alert or message The UPS emits a sustained audible alarm</b>	
The UPS has detected a problem during normal operation.	Follow the instructions on the UPS Display Interface screen. Touch any key to mute all audible alarms.
The UPS Display Interface screen shows the message <b>Disconnected Battery</b> .	Be sure the battery cables are securely connected.
The UPS Display Interface screen shows the message <b>Replace Battery</b> .	Replace all RBMs. Contact customer support.
<b>The UPS display turns red or black, displays an alert message, and emits a sustained audible alarm. Red illumination indicates an UPS alarm that requires immediate attention. Black illumination indicates an UPS alarm that requires attention.</b>	
There is an internal UPS alert or message. 	Do not attempt to use the UPS. Turn the UPS off and have it serviced immediately.
The UPS is experiencing an overload condition. 	Reduce the load on the UPS. Disconnect nonessential equipment.
<b>The Replace Battery alert is displayed</b>	
The RBM has a weak charge.	Allow the RBM to recharge for at least four hours. Then, perform a <b>UPS Self Test</b> . If the problem persists after recharging, replace the battery.
The RBM is not properly connected.	Be sure the battery cable is securely connected.

# Transport

---

1. Shut down and disconnect all connected equipment.
2. Disconnect the unit from mains power.
3. Disconnect internal RBM and XLBPs (if applicable).
4. Follow the shipping instructions outlined in the *Service* section of this manual.

# Service

---

If the unit requires service, do not return it to the dealer. Follow these steps:

1. Review the *Troubleshooting* section of the manual to eliminate common problems.
2. If the problem persists, contact Schneider Electric Customer Support through the our web site, [www.schneider-electric.com](http://www.schneider-electric.com).
  - a. Note the model number and serial number and the date of purchase. The model and serial numbers are located on the rear panel of the unit and are available through the LCD display on select models.
  - b. Call Customer Support. A technician will attempt to solve the problem over the phone. If this is not possible, the technician will issue a Returned Material Authorization Number (RMA#).
  - c. If the unit is under warranty, the repairs are free.
  - d. Service procedures and returns may vary internationally. For country specific instructions refer to our web site, [www.schneider-electric.com](http://www.schneider-electric.com).
3. Shipment of Lithium Ion Battery is highly regulated and the regulation is evolving. Pack the battery and UPS separately.
4. Always contact Customer Support to get the latest guidance on shipment of Lithium ion battery and UPS.
5. Pack the unit properly to avoid damage in transit. Damage sustained in transit is not covered under warranty.
6. Write the RMA# provided by Customer Support on the outside of the package.
7. Return the unit by insured, prepaid carrier to the address provided by Customer Support.

# Limited Factory Warranty

---

Schneider Electric IT Corporation (SEIT), warrants its products to be free from defects in materials and workmanship for a period of five (5) years from the date of purchase. The SEIT obligation under this warranty is limited to repairing or replacing, at its own sole option, any such defective products. Repair or replacement of a defective product or parts thereof does not extend the original warranty period.

This warranty applies only to the original purchaser who must have properly registered the product within 10 days of purchase. Products may be registered online at [warranty.apc.com](http://warranty.apc.com).

SEIT shall not be liable under the warranty if its testing and examination disclose that the alleged defect in the product does not exist or was caused by end user's or any third person's misuse, negligence, improper installation, testing, operation or use of the product contrary to SEIT's recommendations or specifications. Further, SEIT shall not be liable for defects resulting from: 1) unauthorized attempts to repair or modify the product, 2) incorrect or inadequate electrical voltage or connection, 3) inappropriate on site operation conditions, 4) Acts of God, 5) exposure to the elements, or 6) theft. In no event shall SEIT have any liability under this warranty for any product where the serial number has been altered, defaced, or removed.

**EXCEPT AS SET FORTH ABOVE, THERE ARE NO WARRANTIES, EXPRESS OR IMPLIED, BY OPERATION OF LAW OR OTHERWISE, APPLICABLE TO PRODUCTS SOLD, SERVICED OR FURNISHED UNDER THIS AGREEMENT OR IN CONNECTION HEREWITH.**

**SEIT DISCLAIMS ALL IMPLIED WARRANTIES OF MERCHANTABILITY, SATISFACTION AND FITNESS FOR A PARTICULAR PURPOSE.**

**SEIT EXPRESS WARRANTIES WILL NOT BE ENLARGED, DIMINISHED, OR AFFECTED BY AND NO OBLIGATION OR LIABILITY WILL ARISE OUT OF, SEIT'S RENDERING OF TECHNICAL OR OTHER ADVICE OR SERVICE IN CONNECTION WITH THE PRODUCTS.**

**THE FOREGOING WARRANTIES AND REMEDIES ARE EXCLUSIVE AND IN LIEU OF ALL OTHER WARRANTIES AND REMEDIES. THE WARRANTIES SET FORTH ABOVE CONSTITUTE SEIT'S SOLE LIABILITY AND PURCHASER'S EXCLUSIVE REMEDY FOR ANY BREACH OF SUCH WARRANTIES. SEIT WARRANTIES EXTEND ONLY TO ORIGINAL PURCHASER AND ARE NOT EXTENDED TO ANY THIRD PARTIES.**

**IN NO EVENT SHALL SEIT, ITS OFFICERS, DIRECTORS, AFFILIATES OR EMPLOYEES BE LIABLE FOR ANY FORM OF INDIRECT, SPECIAL, CONSEQUENTIAL OR PUNITIVE DAMAGES, ARISING OUT OF THE USE, SERVICE OR INSTALLATION OF THE PRODUCTS, WHETHER SUCH DAMAGES ARISE IN CONTRACT OR TORT, IRRESPECTIVE OF FAULT, NEGLIGENCE OR STRICT LIABILITY OR WHETHER SEIT HAS BEEN ADVISED IN ADVANCE OF THE POSSIBILITY OF SUCH DAMAGES. SPECIFICALLY, SEIT IS NOT LIABLE FOR ANY COSTS, SUCH AS LOST PROFITS OR REVENUE, WHETHER DIRECT OR INDIRECT, LOSS OF EQUIPMENT, LOSS OF USE OF EQUIPMENT, LOSS OF SOFTWARE, LOSS OF DATA, COSTS OF SUBSTITUANTS, CLAIMS BY THIRD PARTIES, OR OTHERWISE.**

**NOTHING IN THIS LIMITED WARRANTY SHALL SEEK TO EXCLUDE OR LIMIT SEIT'S LIABILITY FOR DEATH OR PERSONAL INJURY RESULTING FROM ITS NEGLIGENCE OR ITS FRAUDULENT MISREPRESENTATION OF TO THE EXTENT THAT IT CANNOT BE EXCLUDED OR LIMITED BY APPLICABLE LAW.**

To obtain service under warranty you must obtain a Returned Material Authorization (RMA) number from customer support. Customers with warranty claims issues may access the SEIT worldwide customer support network through our web site: [www.schneider-electric.com](http://www.schneider-electric.com). Select your country from the country selection drop down menu. Open the Support tab at the top of the web page to obtain information for customer support in your region. Products must be returned with transportation charges prepaid and must be accompanied by a brief description of the problem encountered and proof of date and place of purchase.



# Schneider Electric Worldwide Customer Support

Customer support for this or any other APC product is available at no charge in any of the following ways:

- Visit our web site to access documents in the Schneider Electric Knowledge Base and to submit customer support requests.
  - **www.schneider-electric.com** (Corporate Headquarters)  
Connect to localized Schneider Electric web sites for specific countries, each of which provides customer support information.
  - **www.schneider-electric.com/support/**  
Global support searching Schneider Electric Knowledge Base and using e-support.
- Contact the Schneider Electric Customer Support Center by telephone or e-mail.
  - Local, country specific centers: go to **www.schneider-electric.com/support/contact** for contact information.
  - For information on how to obtain local customer support, contact the Schneider Electric representative or other distributor from whom you purchased your APC product.

© 2022 Schneider Electric. All rights reserved. Schneider Electric, Life is On | Schneider Electric, the Schneider Electric logo and Smart-UPS, EcoStruxure and SmartConnect are trademarks of Schneider Electric SE, its subsidiaries or affiliated companies. All other brands may be trademarks of their respective owners.