

LCD Monitor  
SDM-U27M90



Use this Help Guide when you have a question or problem while using this monitor.

## Getting Started

[About the manuals for this monitor](#)

---

### Guide to Parts and Controls

[Front view](#)

---

[Rear view](#)

---

## Setting Up

[Setting up the monitor](#)

---

[Detaching the stand](#)

---

[Adjusting the position of the monitor screen](#)

---

[Carrying the monitor](#)

---

[Making connections](#)

---

## Using the Monitor

[Turning on/off the power](#)

---

[Using the joystick](#)

---

[Switching the input](#)

---

## Changing the Settings

[Using the menu](#)

---

[\[Picture mode\]](#)

---

[\[Gaming assist\]](#)

---

[\[Picture adjustment\]](#)

---

[\[Input\]](#)

---

[\[USB hub\]](#)

---

[\[Audio\]](#)

---

[\[Personalize\]](#)

---

[\[OSD menu\]](#)

---

[\[Others\]](#)

---

## Using the useful functions

[Using the KVM switch \(Auto switch function\)](#)

---

[Using the setting software \(Windows\)](#)

---

## Troubleshooting

[Troubleshooting](#)

---

[Nothing is displayed on the screen](#)

---

[No sound is output from the monitor](#)

---

## Additional Information

[Support sites](#)

---

[Supported Formats](#)

---

## Software Update

[Updating the software](#)

---

LCD Monitor  
SDM-U27M90

## About the manuals for this monitor

---

The content described in this manual are as follows.

### Setup Guide

Explains the setup and connection required to start using this monitor.

### Operating Instructions

Explains the safety precautions.

### Help Guide (this Web manual)

Explains how to use this monitor.

#### Note

- The design and specifications of the monitor are subject to change without notice.

#### Hint

- Letters in brackets [--] displayed on the screen indicate the menu items.
- Details may be omitted from the illustrations.
- The Setup Guide can be downloaded from the support sites.

---

### Related Topic

- [Support sites](#)

LCD Monitor  
SDM-U27M90

## Front view

---

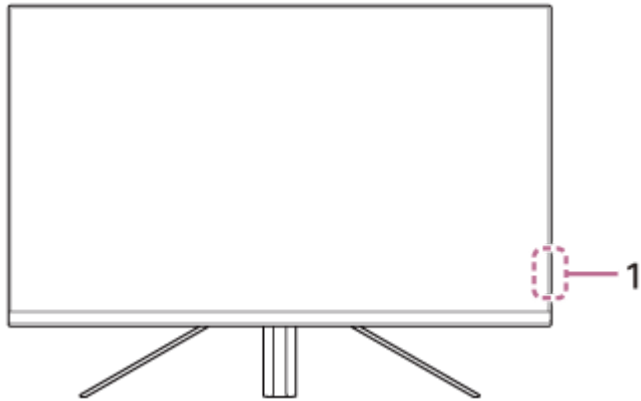

### 1. Power LED

Indicates the monitor status.

- White: power on
- Amber: on standby
- Off: power off

## Rear view

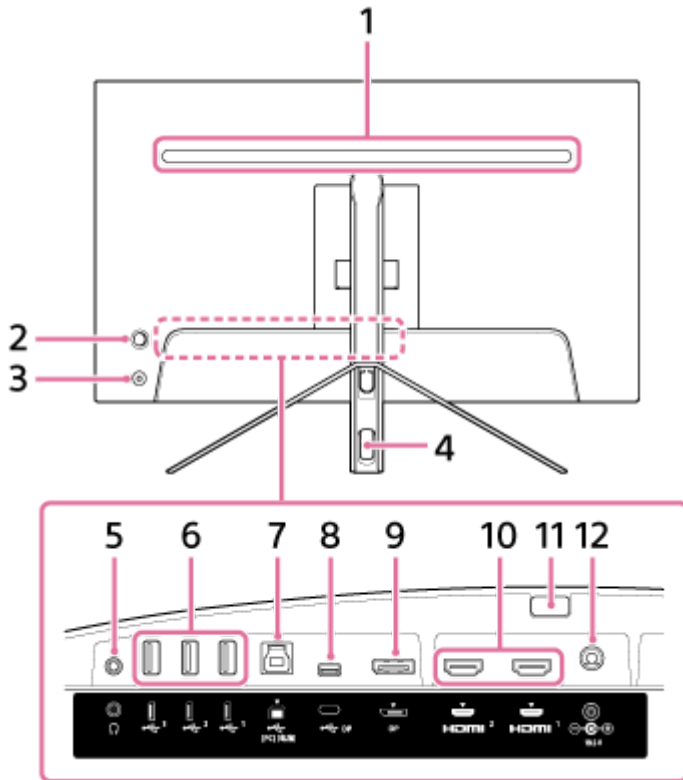

### 1. Rear LED

Lights up when the power is on.  
You can also set the lighting color or turn it off.

### 2. Joystick

Makes the volume adjustment, brightness adjustment, input selection, and various settings by displaying the menu.

### 3. Power button

Turns on the power of the monitor. If you press this button while the monitor is on, the monitor is turned off.

### 4. Cable through hole

Bundles the cables connected to the monitor by passing them through.

### 5. Headphones jack

Connect headphones.  
When headphones are connected, the speakers of this monitor are turned off.

### 6. USB Type-A port 1 to 3

Connect USB peripherals such as a keyboard or mouse.

### 7. USB Type-B port

Connect to the USB port on a computer.

### 8. USB Type-C terminal

Connect to a computer with the USB Type-C terminal equipped.

### 9. DisplayPort port

Connect to a computer with the DisplayPort output equipped.

**10. HDMI port 1, 2**

Connect to a game console or computer with HDMI output equipped.

**11. Stand detach button**

Press to detach the stand.

**12. DC input terminal**

Connect the AC adaptor (supplied).

---

---

**Related Topic**

- [\[Personalize\]](#)
- [Using the joystick](#)
- [Detaching the stand](#)

G-462-100-13(1) Copyright 2022 Sony Corporation

LCD Monitor  
SDM-U27M90

## Setting up the monitor

---

See the Setup Guide for setup and connection of the monitor.

You can also download it from the support sites below.

- For customers in the USA  
<https://www.sony.com/electronics/support>
- For customers in Canada  
<https://www.sony.ca/en/electronics/support>
- For customers in Europe  
<https://www.sony.eu/support>
- For customers in China  
<https://service.sony.com.cn>
- For customers in Asia (or other areas)  
<https://www.sony-asia.com/support>

LCD Monitor  
SDM-U27M90

## Detaching the stand

- 1 Turn off the monitor, maximize the height of the stand, then place it with its LCD panel surface facing down. Lay a soft cloth on a stable surface so that the LCD panel surface is not damaged.

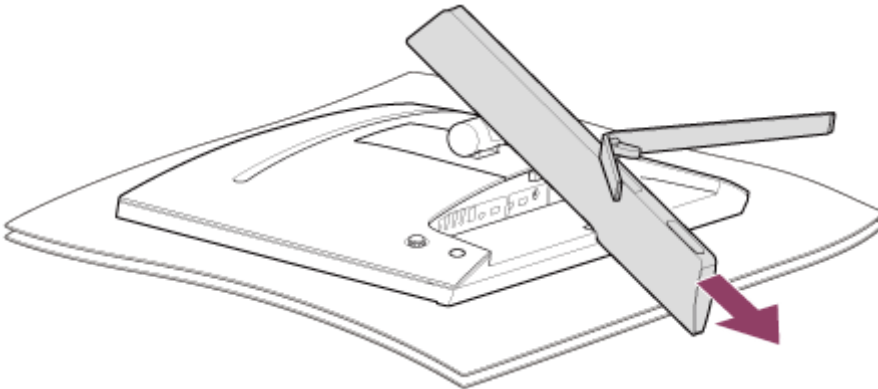

- 2 Press the stand detach button on the rear of the monitor.

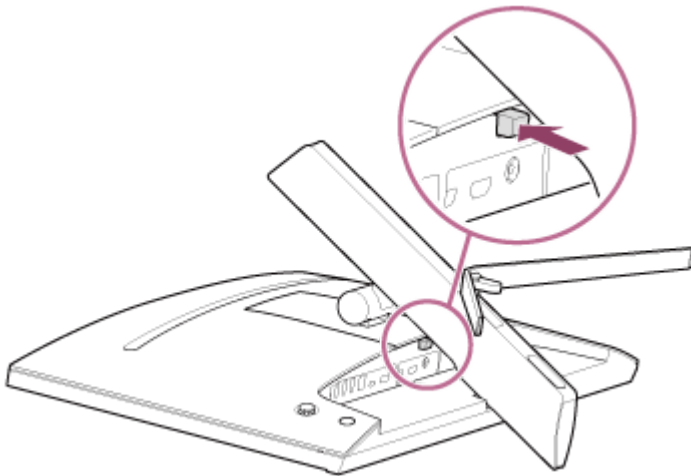

- 3 Lift up the stand.

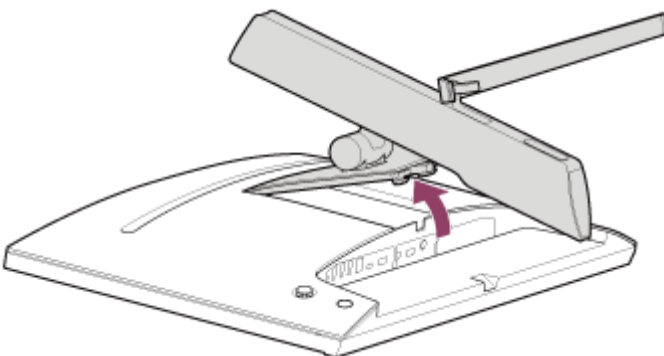

- 4 Pull out the stand from the monitor.



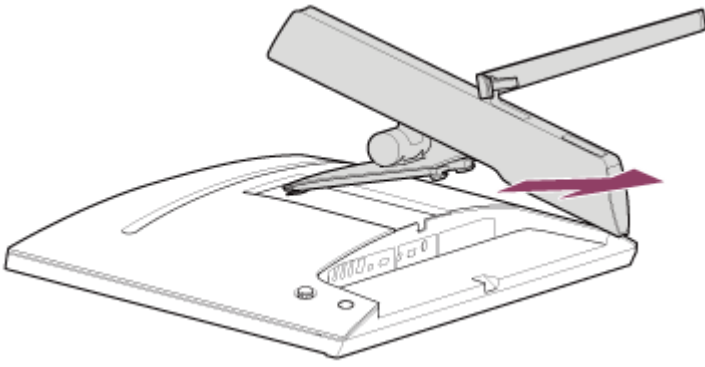

### Note

- When detaching the stand, hold the stand tight so as not to touch the LCD panel surface.
- See the Setup Guide for how to attach the detached stand.

---

### Related Topic

- [About the manuals for this monitor](#)
- [Adjusting the position of the monitor screen](#)

LCD Monitor  
SDM-U27M90

## Adjusting the position of the monitor screen

---

Adjust the height and angle of the monitor to make the screen easier to watch.

### To adjust the height

Hold the monitor tight and adjust its height.  
Be careful not to touch the LCD panel surface during adjustment.

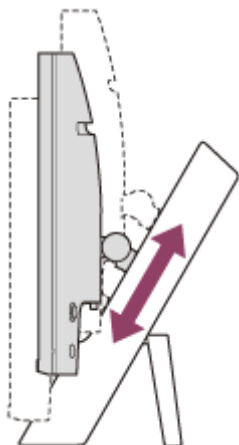

### To adjust the angle

Hold the monitor tight and adjust its angle.  
Be careful not to touch the LCD panel surface during adjustment.

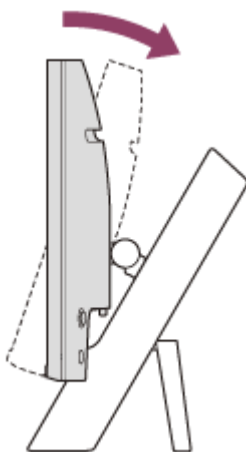

LCD Monitor  
SDM-U27M90

## Carrying the monitor

---

When carrying the monitor, turn the screen towards you, and hold the bottom of the left and right sides with both hands. Be careful not touch the LCD panel surface while carrying the monitor.



LCD Monitor  
SDM-U27M90

## Making connections

You can connect devices such as a computer and/or game console to this monitor.

### Note

- Be sure to unplug the power cable of the monitor when connecting cords of devices.

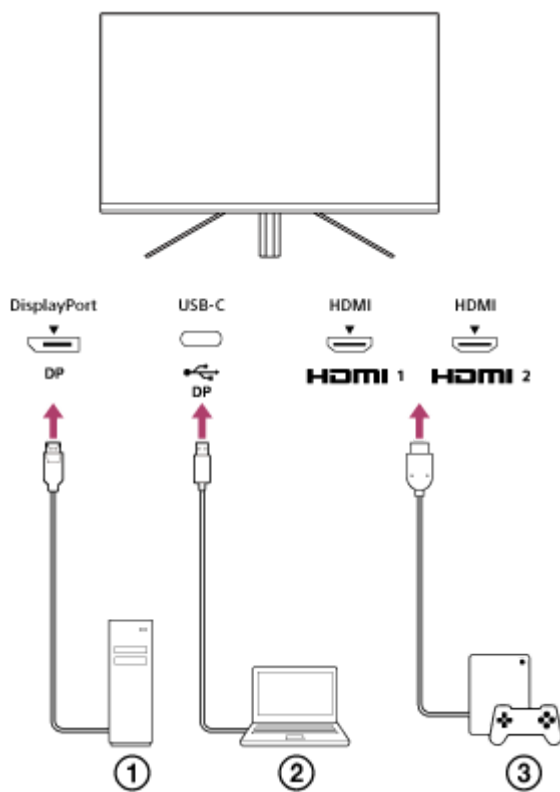

- ① Desktop computer
- ② Laptop computer
- ③ Game console

LCD Monitor  
SDM-U27M90

## Turning on/off the power

---

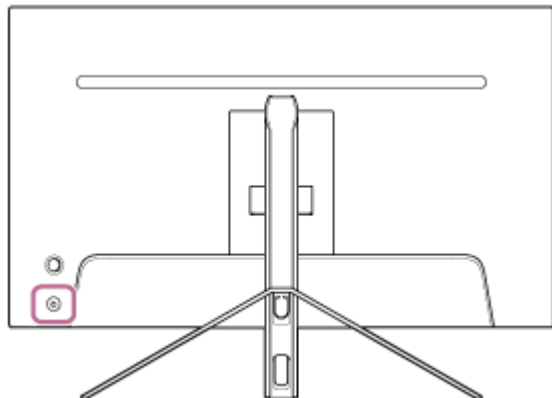

**1 Press the power button.**

The power indicator lights up in white and the monitor turns on.  
Make sure that the connected device is turned on if nothing is displayed on the screen.

**2 To turn off, press the power button.**

The power indicator goes off and the monitor is turned off.

### Hint

- If there is no input signal, the monitor goes into standby mode, and the power indicator lights up in amber.

## Using the joystick

You can use the joystick to make the volume adjustment, brightness adjustment, input selection, and various settings by displaying the menu.

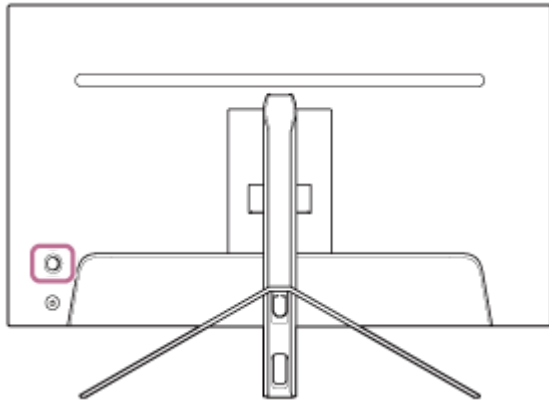

### To adjust the volume

While the menu is not displayed, move the joystick on the rear of the monitor left or right.

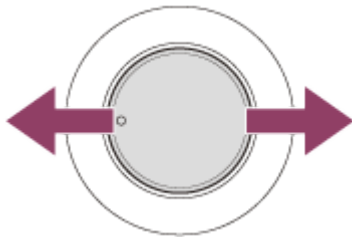

The volume adjustment screen is displayed and you can perform the following operations.

- When viewed from the front, move it to the right (protrusion side) to increase the volume, and move it to the left to decrease the volume.
- Move the joystick down to mute the sound.
- Moving the joystick up while the mute screen is displayed will cancel the muted state and the screen returns to the volume adjustment screen.
- The volume adjustment screen disappears when you press the joystick while the screen is displayed or no operation is performed for a while.

#### Hint

- The volume of the headphones jack and the volume of the built-in speaker can be set separately.

### To adjust the brightness of the screen

While the menu is not displayed, move the joystick on the rear of the monitor up or down.

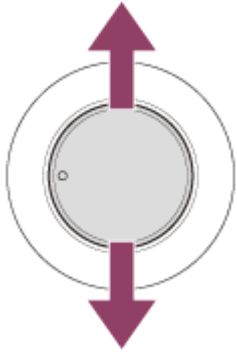

The brightness adjustment screen is displayed and you can perform the following operations.

- Move it up or right to brighten the screen, and move it down or left to darken the screen.
- The brightness adjustment screen disappears when you press the joystick while the screen is displayed or no operation is performed for a while.

### To display the menu

While the menu is not displayed, press the joystick on the rear of the monitor.



The menu is displayed, and you can perform input selection and various settings by moving the joystick up, down, left, and right.

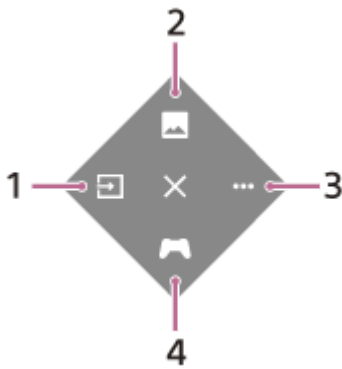

1. Select the input.
2. Adjust the image quality.
3. Make settings related to this monitor.
4. Make settings for useful functions during the game.

### To turn off the menu

Move the joystick repeatedly to the left.

---

#### Related Topic

- [Switching the input](#)
- [\[Picture adjustment\]](#)

- [Others]
- [Gaming assist]
- Using the menu

G-462-100-13(1) Copyright 2022 Sony Corporation



LCD Monitor  
SDM-U27M90

## Switching the input

---

This monitor automatically selects the input to which the signal is being input.

If there are multiple input signals, the inputs are selected in the following order of priority.

HDMI 1→HDMI 2→DisplayPort→USB-C

To switch the input manually, use the joystick.

**1 Press the joystick on the rear of the monitor.**

The menu is displayed.

**2 Move the joystick to the left.**

The input selection menu is displayed.

**3 Select the desired input.**

**4 Press the joystick.**

The input switches to the one selected.

### Note

- When [Auto select] is set to [Off], the input is not selected automatically.
- When [Control for HDMI] is set to [On], the input of that device is automatically selected when turned on or operated.
- If there is no input signal, the input is not selected.

---

### Related Topic

- [\[Input\]](#)

## Using the menu

---

You can make various settings for this monitor on the menu setting screen.

- 1 Press the joystick on the rear of the monitor.**  
The menu is displayed.
- 2 Move the joystick up, down, left, and right.**  
The menu setting screen is displayed.
- 3 Select the desired setting with the joystick, select the setting value, then press it.**

### To turn off the menu setting screen

The menu setting screen will turn off automatically if no operation is performed for a while. Also, move the joystick repeatedly to the left to turn off the setting menu screen.

LCD Monitor  
SDM-U27M90

## [Picture mode]

---

You can select the desired image quality from the presets and adjust the image quality automatically.

- 1 Press the joystick on the rear of the monitor and move it up, down, left, or right to display the setting screen.
- 2 Select the desired setting and press the joystick.

### Details of the menu items

#### [Preset mode]

Select the desired setting from the presets.

[Standard]: Standard image quality mode.

[FPS game]: Suitable for playing FPS (first person shooter) games.

[Cinema]: Suitable for watching movies and videos.

[Game 1], [Game 2]: Saves the settings adjusted in [Picture adjustment] as a preset. If you make adjustments in [Picture adjustment] while [Game 1] or [Game 2] is selected, the settings will be saved automatically.

#### [Auto picture mode]

When an HDMI device is connected, the picture quality is automatically selected to match the content to be played back.

[Off]: Turns off this function.

[On]: Turns on the [Auto picture mode].

#### Note

- When [Auto picture mode] is set to [On], the image quality mode selected in [Auto picture mode] is applied regardless of the [Preset mode] setting.

---

### Related Topic

- [\[Picture adjustment\]](#)

LCD Monitor  
SDM-U27M90

## [Gaming assist]

---

You can make settings for useful functions during the game.

- 1 Press the joystick on the rear of the monitor and move it up, down, left, or right to display the setting screen.**
- 2 Select the desired setting and press the joystick.**

### Details of the menu items

#### [Crosshair]

Turn on the crosshairs (cross mark) in the center of the screen.

[Off]: Turns off the crosshairs.

[Cursor 1] to [Cursor 8]: Select the desired shape to display from the 8 types.

#### [Timer]

Set a timer to indicate the remaining time of the game.

[Off]: Turns off the timer.

[10:00] to [60:00]: Turns on the timer with the time set.

#### [Frame rate counter]

Display the frame rate per second in real time.

[Off]: Does not display the frame rate.

[On]: Displays the frame rate.

#### [Adaptive-Sync/VRR]

Synchronize the refresh rate of this monitor with the frame rate of the video. When turned on, you can suppress the stuttering (lagging) and tearing (flickering) of the screen during the game.

[Off]: Turns off this function.

[On]: Turns on the Adaptive-Sync/VRR function.

#### [Response time]

Change the response speed of the screen.

Set according to the speed of the image movement.

[Standard]: Normal response speed

[Fast]: Slightly increases the response speed of the LCD panel.

[Faster]: Increases the response speed of the LCD panel.

#### [Black equalizer]

Improve visibility in dark areas of the screen.

[0] to [3]: The larger the value, the better the visibility of dark areas.

LCD Monitor  
SDM-U27M90

## [Picture adjustment]

---

You can adjust the image quality such as brightness and contrast.

- 1 Press the joystick on the rear of the monitor and move it up, down, left, or right to display the setting screen.
- 2 Select the desired setting and press the joystick.

### Details of the menu items

#### [Brightness]

Adjust the brightness of the screen.

[0] to [100]: The higher the value, the brighter the screen.

#### [Contrast]

Adjust the contrast of the screen.

[0] to [100]: The higher the value, the larger the difference between the brightness and darkness of the screen.

#### [Sharpness]

Adjust the sharpness of the screen.

[0] to [100]: The higher the value, the clearer the screen, and the lower the value, the softer the screen.

#### [Gamma]

Select the gamma value from [1.8], [2.0], [2.2], and [2.4], and set it to be the optimum condition according to the image. The lower the gamma value, the brighter the intermediate colors (other than white and black).

#### [Local dimming]

Individually control the screen backlight according to the image and increase screen contrast.

[Off]: Turns off this function.

[Low], [High]: Select the effect level to apply.

#### [Hue]

Adjust the hue of the screen.

[0] to [100]: The higher the value, the more greenish the color, and the lower the value, the more purplish the color.

#### [Saturation]

Adjust the color density of the screen.

[0] to [100]: The higher the value, the deeper the color, and the lower the value, the lighter the color.

#### [Color temperature]

Adjust the color temperature of the screen.

[Neutral]: Sets to standard color temperature.

[Warm]: Lowers the color temperature (to be reddish) of the screen.

[Cool]: Raises the color temperature (to be bluish) of the screen.

[Custom]: Adjusts the red, green, and blue values to set the desired color temperature.

- [Red]: Adjusts the red value.
- [Green]: Adjusts the green value.
- [Blue]: Adjusts the blue value.

**[Aspect ratio]**

Set the aspect ratio of the screen.

[16:9]: Sets the aspect ratio to 16:9.

[Auto resize]: Adjusts the aspect ratio according to the image.

[4:3]: Sets the aspect ratio to 4:3.

[Original]: Displays images with the original aspect ratio maintained.

**Hint**

- You can also adjust the brightness of the screen by moving the joystick up or down while the menu is not displayed.
- While the video in HDR signal format is input, [Brightness] cannot be adjusted.

LCD Monitor  
SDM-U27M90

## [Input]

---

You can select the input and make settings related to the input.

- 1 Press the joystick on the rear of the monitor and move it up, down, left, or right to display the setting screen.**
- 2 Select the desired setting and press the joystick.**

### Details of the menu items

#### [HDMI 1]

Selects the HDMI 1 input.

#### [HDMI 2]

Selects the HDMI 2 input.

#### [DP]

Selects the DisplayPort input.

#### [USB-C (DP Alt Mode)]

Selects the USB-C input.

#### [Auto select]

Select the input with the input signal automatically.

If there are multiple input signals, the inputs are selected in the following order of priority.

HDMI 1→HDMI 2→DisplayPort→USB-C

[Off]: Turns off this function.

[On]: Turns on the auto input select function.

#### [Control for HDMI]

In conjunction with the monitor, you can perform operations, such as turning on/off or selecting the input, of the device connected with an HDMI cable.

[Off]: Turns off this function.

[On]: Turns on the HDMI device control function.

#### [DP version number]

Set the DisplayPort version number.

Set to the same version as the DisplayPort of the connected device.

[1.2]/[1.4]

LCD Monitor  
SDM-U27M90

## [USB hub]

---

You can make settings related to the KVM switch and USB power supply.

- 1 Press the joystick on the rear of the monitor and move it up, down, left, or right to display the setting screen.
- 2 Select the desired setting and press the joystick.

### Details of the menu items

#### [KVM switch 1]/[KVM switch 2]

When 2 external devices such as a computer or game console are connected, you can use the USB device connected to the monitor to control either of the external devices selected.

[KVM switch 1] is associated with the USB-C upstream and [KVM switch 2] is associated with the USB-B upstream.

[HDMI 1 sync]: Links the HDMI 1 video input signal with the USB upstream.

[HDMI 2 sync]: Links the HDMI 2 video input signal with the USB upstream.

[DP sync]: Links the DP video input signal with the USB upstream.

[USB-C sync]: Links the USB-C video input signal with the USB upstream.

[Sync off ]: Does not link.

#### [USB charge (power off)]

Set whether to charge the device connected to the USB terminal when this monitor is in standby mode.

[Off]: Does not charge during sleep.

[On]: Charges during sleep.

#### Note

- For USB power supply, USB-B and USB-C upstream connections are required.
- When updating the software of the monitor, connect the computer with the setting software installed to this monitor via USB, and set [KVM switch 1]/[KVM switch 2] correctly.

---

### Related Topic

- [Using the KVM switch \(Auto switch function\)](#)
- [Updating the software](#)



LCD Monitor  
SDM-U27M90

## [Audio]

---

You can adjust the volume.

- 1** Press the joystick on the rear of the monitor and move it up, down, left, or right to display the setting screen.
- 2** Select the desired setting and press the joystick.

### Details of the menu items

#### [Audio]

[0] to [100]: The higher the value, the louder the volume.

#### Hint

- When the menu is not displayed on the screen, you can adjust the volume by moving the joystick left and right.

LCD Monitor  
SDM-U27M90

## [Personalize]

---

You can make the settings of the power LED and rear LED.

- 1** Press the joystick on the rear of the monitor and move it up, down, left, or right to display the setting screen.
- 2** Select the desired setting and press the joystick.

### Details of the menu items

#### [Power LED]

You can turn off the power LED even though the monitor is turned on.

[On]: Turns on the power LED.

[Off]: Turns off the power LED.

#### [Rear lighting]

You can turn off the rear LED or change the lighting color even though the monitor is turned on.

[Black (Off)]: Turns off the LED.

[Blue magenta]/[Magenta]/[Red magenta]/[Red]/[Orange]/[Yellow]/[Green yellow]/[Green]/[Green cyan]/[Cyan]/[Blue cyan]/[Blue]/[White]: Lights up in the set color.

LCD Monitor  
SDM-U27M90

## [OSD menu]

---

You can set the language and other details of the menu setting screen.

- 1** Press the joystick on the rear of the monitor and move it up, down, left, or right to display the setting screen.
- 2** Select the desired setting and press the joystick.

### Details of the menu items

#### [Language]

Set the language of the menu setting screen.

#### [Transparency]

Set the transparency of the menu setting screen.

[0] to [100]: The higher the value, the greater the transparency.

#### [OSD time out]

Set the time for displaying the menu setting screen.

[5s] to [60s]: Set between 5 seconds to 60 seconds. After the set time has elapsed, the menu setting screen closes.

LCD Monitor  
SDM-U27M90

## [Others]

---

You can make settings related to this monitor and initialize this monitor.

- 1 Press the joystick on the rear of the monitor and move it up, down, left, or right to display the setting screen.
- 2 Select the desired setting and press the joystick.

### Details of the menu items

#### [DDC/CI]

Make settings on this monitor using the dedicated software on the computer.

[Off]: Turns off this function.

[On]: Turns on the DDC/CI function.

#### [Software version]

The software version of this monitor can be viewed.

#### [Power saving]/[Eco mode]

Reduce the screen brightness to lower the power consumption.

[Off]: Turns off this function. Consumes power normally.

[On]: Turns on the Power saving function.

#### [Text magnification]

The letters on the menu setting screen are displayed in large sizes.

[Off]: Turns off this function.

[On]: Turns on the Text magnification function.

[Text magnification] works only when [Language] is set to [English].

#### [Screen reader]

You can operate the monitor by voice without watching the screen.

[Off]: Turns off this function.

[On]: Turns on the Screen reader function.

[Screen reader] works only when [Language] is set to [English].

#### [Factory reset]

Resets the settings of the monitor to the factory default.

Note that all the settings of the monitor return to the factory default.

#### Note

- Mute does not work for the audio of Screen reader.
- The audio volume of Screen reader cannot be adjusted when headphones are connected to the headphones jack.
- [Text magnification] and [Screen reader] can be set only when [Power saving]/[Eco mode] is set to [Off].
- When [Power saving]/[Eco mode] is set to [On], the following setting items cannot be changed. [Adaptive-Sync/VRR], [Black equalizer], [KVM switch 1], [KVM switch 2], [USB charge (power off)], [Rear lighting], [Text magnification], and [Screen reader]



## Using the KVM switch (Auto switch function)

KVM stands for "Keyboard, Video, Mouse".

When 2 devices such as a computer or game console are connected to this monitor, you can select the USB device (such as a keyboard and mouse) that controls them all at once.

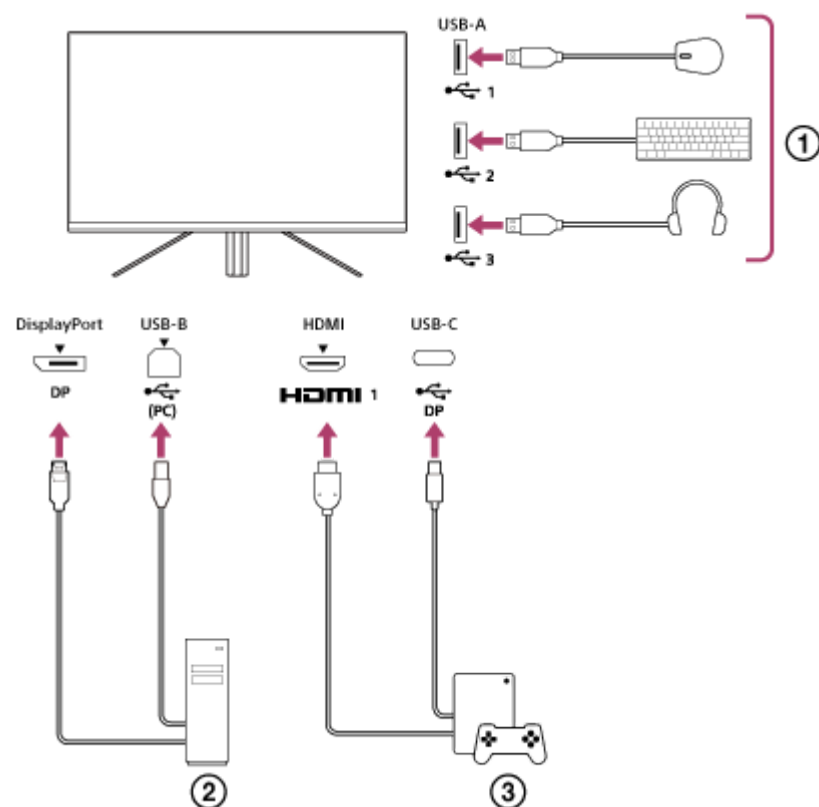

- ① Mouse, keyboard, headset, etc.
- ② Computer
- ③ Game console

When the connection is made as shown in the diagram above, the USB device ( ① ) that controls the computer ( ② ) and game console ( ③ ) can be selected all at once.

[KVM switch 1] is associated with the USB-C upstream and [KVM switch 2] is associated with the USB-B upstream.

### How to set

1. Press the joystick on the rear of the monitor and move it up, down, left, or right to display the menu.
2. Select [USB hub]-[KVM switch 1], then press the joystick.
3. Select the input of the device to be assigned to [KVM switch 1] and press the joystick. (In the case of the above figure, select [HDMI 1 sync].)  
The device is assigned to [KVM switch 1]. (In the case of the above figure, the game console connected to HDMI port 1 is applicable.)
4. Similarly, select [USB hub]-[KVM switch 2], then press the joystick.

5. Select the input of the device to be assigned to [KVM switch 2], then press the joystick. (In the case of the above figure, select [DP sync].)  
The device is assigned to [KVM switch 2]. (In the above figure, a computer connected to the DisplayPort terminal is applicable.)

## How to switch

1. Press the joystick on the rear of the monitor, move it left to select  [Input], then press it.

2. Select the input assigned to [KVM switch 1] or [KVM switch 2].

You can operate the selected device with the USB device connected to this monitor.

### Note

- When updating the software of the monitor, connect the computer with the setting software installed to this monitor via USB, and set [KVM switch 1]/[KVM switch 2] correctly.
- The KVM switch can be set only when [Power saving]/[Eco mode] is set to [Off].

### Hint

- To control the selection of input devices, connecting a computer or game console to this monitor with a USB cable is required.

---

## Related Topic

- [Using the joystick](#)
- [Using the menu](#)
- [\[USB hub\]](#)
- [\[Others\]](#)
- [Updating the software](#)

LCD Monitor  
SDM-U27M90

## Using the setting software (Windows)

---

By using the software, you can make various settings for this monitor from your computer.  
The software can be downloaded from the support sites below.

- For customers in the USA  
<https://www.sony.com/electronics/support>
  - For customers in Canada  
<https://www.sony.ca/en/electronics/support>
  - For customers in Europe  
<https://www.sony.eu/support>
  - For customers in China  
<https://service.sony.com.cn>
  - For customers in Asia (or other areas)  
<https://www.sony-asia.com/support>
- 

### Related Topic

- [Updating the software](#)



LCD Monitor  
SDM-U27M90

## Troubleshooting

---

If the monitor is not working properly, check again for problems before sending it for repair.  
Should any problems persist, consult your nearest Sony dealer.

G-462-100-13(1) Copyright 2022 Sony Corporation

LCD Monitor  
SDM-U27M90

## Nothing is displayed on the screen

---

- Check that the power cord (mains lead) and the connection cords with other devices are connected securely.
  - Press the power button on the rear of the monitor to turn on the power.
  - Turn on the power of other devices.
- 
- 

### Related Topic

- [Making connections](#)

LCD Monitor  
SDM-U27M90

## No sound is output from the monitor

---

- Move the joystick left or right to adjust the volume.
- 

### Related Topic

- [Using the joystick](#)

G-462-100-13(1) Copyright 2022 Sony Corporation

LCD Monitor  
SDM-U27M90

## Support sites

---

Visit the support sites below for the latest information.

- For customers in the USA  
<https://www.sony.com/electronics/support>
- For customers in Canada  
<https://www.sony.ca/en/electronics/support>
- For customers in Europe  
<https://www.sony.eu/support>
- For customers in China  
<https://service.sony.com.cn>
- For customers in Asia (or other areas)  
<https://www.sony-asia.com/support>

## Supported Formats

Each input supports the formats marked with " ○ ".

### PC formats

Resolution	Vertical frequency (Hz)	HDMI	DP/USB-C (DP Alt Mode)
640×480	60	○	○
800×600	60	○	○
1024×768	60	○	○
1280×1024	60	○	○
1920×1080	60	○	○
1920×1080	120	○	○
2560×1440	60	○	○
2560×1440	120	○	○
2560×1440	144		○
3840×2160	24	○	○
3840×2160	25	○	○
3840×2160	30	○	○
3840×2160	60	○	○
3840×2160	95		○
3840×2160	120	○	○
3840×2160	144		○

### CE formats

Resolution	Vertical frequency (Hz)	HDMI	DP/USB-C (DP Alt Mode)
640×480	60	○	○
720×480	59.94	○	○
720×480	60	○	○
720×576	50	○	○
1280×720	50	○	○

Resolution	Vertical frequency (Hz)	HDMI	DP/USB-C (DP Alt Mode)
1280×720	60	○	○
1920×1080	24	○	○
1920×1080	25	○	○
1920×1080	30	○	○
1920×1080	50	○	○
1920×1080	60	○	○
1920×1080	120	○	○
2560×1440	60	○	○
3840×2160	24	○	○
3840×2160	25	○	○
3840×2160	30	○	○
3840×2160	50	○	○
3840×2160	60	○	○
3840×2160	120	○	○

G-462-100-13(1) Copyright 2022 Sony Corporation

LCD Monitor  
SDM-U27M90

## Updating the software

---

When there is an update of the software, you can update the software of the monitor using a computer (Windows).

- 1 See "[Using the setting software \(Windows\)](#)" and download the setting software.
- 2 See "[Using the KVM switch \(Auto switch function\)](#)" and make the USB upstream connection and video input connection.
- 3 Follow the instructions of the setting software to update the software of the monitor.

### Note

- The rear LED flashes during the software update.
- After the software update is complete, unplug the power cable from the outlet and plug it in again.
- When updating the software, connect only one monitor. Do not connect 2 or more monitors.

---

### Related Topic

- [Using the KVM switch \(Auto switch function\)](#)
- [Using the setting software \(Windows\)](#)