



USER GUIDE

LG Digital Signage

(MONITOR SIGNAGE)

Please read this manual carefully before operation and retain it for future reference.

L19

CONTENTS

SETTINGS4

- Home.....	4
Global Buttons	
Dashboard	
[Content Manager]	
- Ez Setting	5
[Video Wall]	
[On/Off Scheduler]	
[Server Setting]	
[Fail Over]	
[Data Cloning]	
[Sync Mode]	
- General.....	8
[Language]	
[System Information]	
[Set ID]	
[Time & Date]	
[Power]	
[Network]	
[Safety Mode]	
[Advanced Setting]	

- Display	19
[Picture Mode Settings]	
[Aspect Ratio]	
[Rotation]	
[Advanced Setting]	
- Sound.....	23
[Sound Mode Settings]	
[Audio Out]	
[AV Sync Adjustment]	
[Digital Audio Input]	
- Admin.....	25
[Admin Lock]	
[Change Password]	
[Lock Mode]	
[Reset to Initial Settings]	
[Ez Download]	
[Factory Reset]	
- Picture ID.....	27

CONTENT MANAGER 28

- Content Manager28
 - [Player]
 - [Scheduler]
 - [Playlist]

IR CODE 37

CONTROLLING MULTIPLE PRODUCTS..... 39

- Connecting cables39
- Communication Parameter40
- Command Reference List41
- Transmission/Reception Protocol45

To obtain the source code under GPL, LGPL, MPL, and other open source licenses, that is contained in this product, please visit <http://opensource.lge.com>.

In addition to the source code, all referred license terms, warranty disclaimers and copyright notices are available for download.

LG Electronics will also provide open source code to you on CD-ROM for a charge covering the cost of performing such distribution (such as the cost of media, shipping, and handling) upon email request to opensource@lge.com.

This offer is valid for a period of three years after our last shipment of this product. This offer is valid to anyone in receipt of this information.



NOTE

- Software-related content may be changed without prior notice due to upgrades of the product functions.
- Some features described in the User Manual may not be supported in certain models and countries.
- SNMP 2.0 is supported.

SETTINGS

Home

Global Buttons

-  [Position]: You can set the location of the rotated OSD as Top/Center/Bottom.
-  [Input]: Navigate to the external input selection screen.
-  [Settings]: Navigate to the Settings screen.

NOTE

- When the OSD rotation is set to 90/270, [Position] appears.

Dashboard

- This feature displays key information about your Signage monitor in the center of the home screen. In the Dashboard, you can manually change settings by selecting the corresponding items.

NOTE

- If the dashboard is locked, the focus does not move.

[Content Manager]

- [Player]: Play a variety of content including images, videos, music and SuperSign content.
- [Scheduler]: Manage schedules for content that will be played at different times.
- [Playlist]: Create a playlist with photos and videos.

Ez Setting

[Video Wall]

SETTINGS / ⚙️ → [Ez Setting] → [Video Wall]

Set Video Wall options to create a wide visual canvas.

- [Tile Mode]: Turn [Tile Mode] on or off. Display a single integrated screen on multiple Signage monitors.
- [Natural Mode]: Display the image excluding the area that overlaps with the monitor's bezel so that the image displayed has a more natural feel to it.
- [Scan Inversion]: This function reduces the differences in image sync between screens adjacently installed above and below to each other when the high-speed screen is enabled.
- [White Balance Setting]: Set the white balance. (menu position, picture mode, white pattern, color temperature, RGB gain and backlight)
- [Reset]: Reset to initial settings.

[On/Off Scheduler]

SETTINGS / ⚙️ → [Ez Setting] → [On/Off Scheduler]

Set a schedule to use your signage by time and day of the week.

- [On/Off Time Setting]: Set on/off times for each day of the week.
- [Holiday Setting]: Set holidays by date and by day of the week.

[Server Setting]

SETTINGS / ⚙️ → [Ez Setting] → [Server Setting]

Set up to connect your signage to a SuperSign server.

- [CMS Server]
- [Control Server]

[Fail Over]

SETTINGS /  → [Ez Setting] → [Fail Over]

This feature enables automatically switching to other input sources in order of priority if the primary signal is interrupted. It also enables the automatic playback of the photo and video content stored on your device.

- [Off]: Turn off the Fail Over function.
- [Auto]: Switch to other input sources in the predetermined order if there is no signal from the current input.
- [Manual]: Set switching priorities for inputs when there is no signal. In case there are multiple video signals, the current input switches to the input with the highest priority.
- [Reset]: Reset to initial settings.
- [USB]: You can set this option to [Off], [Movie], or [Photo].
 - [Off]: Disable the Fail Over USB function.
 - [Movie]: If you set this feature to [Auto], a video is played back when there is no input signal. If you set this feature to [Manual], a movie is played back when there is no signal from any of the prioritized inputs.
 - [Photo]: If you set this feature to [Auto], a photo slideshow is played back when there is no input signal. If you set this feature to [Manual], a photo slideshow is played back when there is no signal from any of the prioritized inputs.

NOTE

- The number of priorities may vary depending on the model.
- When [Mode] is set to [Off], all of its sub-menus are disabled.
- When [Mode] is set to [Auto], the Priority menu is disabled.
- When [USB Lock] in [Lock Mode] is turned on, the menu items of the USB [Fail Over] feature are disabled, and the feature stops working.
- For the USB [Fail Over] feature to normally work, your USB drive must have a folder named "FAIL_OVER" or "fail_over", as well as valid content (a video or an image).
- If your USB drive does not have a folder named "FAIL_OVER" or "fail_over" or the folder has no content, the default USB pop-up menu appears when the operation of the USB [Fail Over] feature starts.
- The USB [Fail Over] feature will be disabled after the distribution of content (or the scheduled playback of the content). However, if a [Fail Over] event (input signal connection / changes in the USB [Fail Over] feature menus / USB reconnection) occurs, the USB [Fail Over] feature will be enabled again.
- The USB [Fail Over] feature is disabled during the playback of content or while in standby for the scheduled playback.
- The USB [Fail Over] feature is disabled during software updates (including [EZ Download]).
- If both USB 1 and USB 2 have a USB storage device connected to them, the content stored in USB 1 will be played back.

[Data Cloning]

SETTINGS / ⚙️ → [Ez Setting] → [Data Cloning]

This feature is used to copy and import the settings of the device to other devices.

- [Export Setting Data]: Export the settings of the device to another device.
- [Import Setting Data]: Import the settings of another device into the device.

[Sync Mode]

SETTINGS / ⚙️ → [Ez Setting] → [Sync Mode]

Sync up time and content among multiple signage.

- [Sync Mode]: Sync up time and content among multiple signages.
 - [Master]: Select as the Master.
 - [Slave]: Play content at the same time as the Master monitor.
- [Contents Sync]: Sync the start times of content (videos or images that have been distributed by SuperSign Software) played back on the Master and Slave monitors.
 - On/Off: Enable or disable Content Sync feature.
- [Time Sync]: Sync the Slave monitors' clocks to the Master monitor's at a specified time via RS-232C.
 - [Off](0:00 - 23:00): Set the sync time.

General

[Language]

SETTINGS / ⚙️ → [General] → [Language]

You can select the menu language to be displayed on the screen.

- [Menu Language]: Sets the language of your Signage monitor.

[System Information]

SETTINGS / ⚙️ → [General] → [System Information]

This feature displays information such as the device name, software version, and storage space.

[Set ID]

SETTINGS / ⚙️ → [General] → [Set ID]

- [Set ID] (1-1000): Assigns a unique Set ID number to each product when several products are connected via RS-232C. Assign numbers ranging from 1 to 1000 and exit the option. You can control each product separately by using the Set ID you assigned to each product. (For some models, the range of assign numbers is 1-255.)
- [Auto Set ID]: Automatically assigns a unique Set ID number to each product when several products are connected for display.
- [Reset Set ID]: Reset the Set ID of the product to 1.

[Time & Date]

SETTINGS / ⚙️ → [General] → [Time & Date]

This feature enables you to view and change the time and date on the device.

- [Set Automatically]: Set [Time] and [Date].
- [Daylight Saving Time]: Set the start and end times for Daylight Saving Time. The DST start/end times function only when you set them more than one day apart from each other.
- [Time Zone]: Configure the continent, country/region and city.
 - Select manual in [City] to set [Custom Time Zone].

[Power]

SETTINGS / ⚙️ → [General] → [Power]

Power-related feature settings

[No Signal Power Off](15 min.)

Set whether to use the 15 Min Auto Off feature.

- You can set this option to [On] or [Off].
- If you set this feature to [On], the product turns off when it has remained in No Signal status for 15 minutes.
- If you set this feature to [Off], the 15 Min Force Off feature is disabled.
- It is recommended that you set this feature to [Off] if you intend to use the product for long periods of time as the feature turns the power of the product off.

[No IR Power Off]

Set whether to use the No IR Power Off feature.

- You can set this option to [Off], [2 hours], [4 hours], [6 hours], or [8 hours].
- If you set this feature to [2 hours], [4 hours], [6 hours] or [8 hours], the product turns off if there is no input from the remote control for the corresponding period.
- If you set this feature to [Off], the No IR Power Off feature is disabled.
- It is recommended that you set this feature to [Off] if you intend to use the product for long periods of time as the feature turns the power of the product off.

[DPM]

Set the Display Power Management (DPM) mode.

- If this feature is not set to [Off], the monitor will enter DPM mode when there is no input signal.
- If you set this feature to [Off], [DPM] is disabled.
- You can set this feature to [Off], [5 sec.], [10 sec.], etc.

[DPM Wake Up Control]

Set conditions for releasing the DPM status according to the digital signal processing of the connected DVI/HDMI port.

- When set to [Clock], the set checks for digital clock signals and releases the DPM status once it finds the clock signal.
- When set to [Clock+DATA], the set releases the DPM status when both the clock signal and data of the digital signal are entered.

[PM Mode]

- [Power Off](Default): Sets the normal DC off mode.
- [Sustain Aspect Ratio]: Identical to normal DC off mode except that the Switching IC remains on. On certain models, this applies only to a specific input mode (DisplayPort) and has the same effect as [Screen Off Always] in other input modes.
- [Screen Off]: Switches to [Screen Off] status when entering DPM, Auto Power Off (15 min, 4 hours), or Abnormal Shut Down mode.
- [Screen Off Always]: Switches to [Screen Off] status when entering DPM, Auto Power Off (15 min, 4 hours), Off Time Scheduling, or Abnormal Shut Down mode, or when there is input from the remote control's Power button or the monitor's Off button.

**NOTE**

- In order for the screen to switch from [Screen Off] to On status, there must be input from the remote control's Power or Input button, or the monitor's On button.

[Power On Delay](0-250)

- This feature prevents overload by implementing a power-on delay when multiple monitor sets turn on.
- You can set the delay interval in the range of 0 to 250 seconds.

[Power On Status]

- Select the operating status of the monitor when the main power has turned on.
- You can choose from among PWR (Power On), STD (Standby), and LST (Last Status).
- PWR (Power On) keeps the monitor powered on when the main power has turned on.
- STD (Standby) switches the monitor to Standby status when the main power has turned on.
- LST (Last Status) switches the monitor back to its previous status.

[Wake On LAN]

- Set whether to use [Wake On LAN].
- You can set the feature to On or Off for wired network.
- Wired Network: When set to [On], the Wake On LAN feature is enabled, letting you turn the product on remotely through a wired network.

[Power On/Off History]

Display the device's power on/off history.

[Network]

SETTINGS / ⚙️ → [General] → [Network]

[Wired Connection (Ethernet)]

- **Wired Connection:** Connects the monitor to a local area network (LAN) via the LAN port and configures wired network settings. Only wired network connections are supported. After setting up a physical connection, the display will automatically connect without any adjustments on most networks. A small number of networks may require the display settings to be adjusted. For detailed information, contact your Internet provider or consult your router manual.

[Wi-Fi Connection]

If you have set your monitor up for a wireless network, you can view and connect to available wireless Internet networks.

- [Input the new SSID]: You can add a wireless network by manually typing in its name.
- [Access Point Search]: Search access point again.
- [WPS PBC]: Press the button on the wireless router that supports PBC to easily connect to the router.

! NOTE

- When connected to a network that supports IPv6, you can select IPv4/IPv6 in the advanced wired/wireless network setting. But, IPv6 connection only supports automatic connection.

Tips for Network Settings

- Use a standard LAN cable (Cat5 or higher with an RJ45 connector) with this display.
- Many network connection problems during set up can often be fixed by re-setting the router or modem. After connecting the display to the home network, quickly power off and/or disconnect the power cable of the home network router or cable modem, Then power on and/or connect the power cable again.
- Depending on the Internet service provider (ISP), the number of devices that can receive INTERNET service may be limited by the applicable terms of service. For details, contact your ISP.
- LG is not responsible for any malfunction of the display or Internet connection failures due to communication errors/malfunctions associated with your Internet connection or other connected equipment.
- LG is not responsible for problems within your INTERNET connection.
- You may experience undesired results if the network connection speed does not meet the requirements of the content being accessed.
- Some INTERNET connection operations may not be possible due to certain restrictions set by the Internet service provider (ISP) supplying your Internet connection.
- Any fees charged by an ISP including, without limitation, connection charges are your responsibility.

NOTE

- If you want to access the Internet directly on your display, the INTERNET connection should always be on.
- If you cannot access the Internet, check the network conditions from a PC on your network.
- When you use Network Setting, check the LAN cable or check if DHCP in the router is turned on.
- If you do not complete the network settings, the network may not function correctly.

CAUTION

- Do not connect a modular phone cable to the LAN port.
- Since there are various connection methods, please follow the specifications of your telecommunication carrier or INTERNET service provider.
- Network setting menu will not be available until the display connected to physical network.
- When a Wi-Fi dongle is used with a model that has only one USB input port, the distribution or content schedule via the SuperSign software is not available.

Tips for When Configuring Wireless Network Settings

- The wireless network may be affected by interference from a device that uses 2.4 GHz frequency, such as a wireless telephone, Bluetooth device or microwave. Interference may also be caused by a device that uses 5 GHz frequency such as Wi-Fi devices.
- The wireless network service may run slowly depending on the surrounding wireless environment.
- Some devices may have a network traffic jam if any local home networks are turned on.
- To connect to a wireless router, a router that supports wireless connection is necessary; the wireless connection function of the corresponding router must also be activated. Ask the router manufacturer whether the router supports wireless connection.
- To connect to a wireless router, verify the SSID and security settings of the wireless router. Please refer to the user guide of the corresponding router regarding SSID and security settings of the wireless router.
- The monitor may not work properly if network devices (wire/wireless router or hub, etc.) are incorrectly set up. Be sure to install the devices correctly by referring to their user guides before configuring the network connection.
- The connection method may vary according to the manufacturer of the wireless router.

[Safety Mode]

SETTINGS / ⚙️ → [General] → [Safety Mode]

Set to this function for safe performance.

[ISM Method]

If a still image is displayed on the screen for an extended period of time, image sticking can occur. The ISM method is a feature that prevents image sticking.

[Mode]

- Sets the [ISM Method] mode.
- [Normal]: Disables the ISM Method.
- [Orbiter]: Moves the image's position on the screen by 3 pixels in a certain order to remove image sticking.
- [Inversion]: Inverts screen colors to remove image sticking.
- [Color Wash]: Alternately displays a white pattern and a color pattern to remove image sticking.
- [White Wash]: Displays a white pattern to remove image sticking.
- [Washing Bar]: Displays a bar on the screen to make the image move smoothly. You can download a desired image and display it on the bar.
- [User Image]: Plays your photos or movies using a USB storage device.

[Timer]

- [Immediately]: Performs the ISM function immediately.
- [Repeat]: Performs the ISM function for the amount of time set in [Time] if the still image is maintained for the period set in [Period].
- [Scheduling]: Performs the ISM function according to settings in [Repeat Day], [Start Time] and [End Time].

[Period]

- This option is available only when [Timer] is set to [Repeat].
- You can set the period between 1 and 24 hours.
- The ISM function is performed if the still image is maintained for the set period.

[Time]

- This option is available only when [Timer] is set to [Repeat].
- You can select from among 1 - 10 min / 20 min / 30 min / 60 min / 90 min / 120 min / 180 min / 240 min.
- The ISM function is performed for the set time.

[Bar Image]

- This option is only available when [Washing Bar] is selected.
- [Off]: Displays a bar with a fixed resolution of 300 x 1080, then moves the bar.
- [On]: Displays a user-downloaded image, and moves the image. The image height is fixed at 1080 and the original width is maintained. However, the width is fixed at 300 if the original width is less than 300.
- If you download only 1 image, the image is displayed alone and the bar moves.
- If multiple images are downloaded, up to 4 images are consecutively displayed per cycle.

[Bar Color]

- This option is applied when [Bar Image] is [Off].
- This option is only available when [Washing Bar] is selected.
- You can choose from 6 colors: [Red] / [Green] / [Blue] / [White] / [Black] / [Gray]

[Bar Transparency]

- This option is only available when [Washing Bar] is selected.
- [Off]: Displays the bar opaquely.
- [On]: Displays the bar translucently. (Transparency: 50 %)

[Bar Direction]

- This option is only available when [Washing Bar] is selected.
- [Left to Right]: The bar moves from left to right.
- [Right to Left]: The bar moves from right to left.

[User Image]

- This option is only available when [User Image] is selected.
- You can choose [Movie] or [Photo].

[Repeat Day]

- This option is available only when [Timer] is set to [Scheduling].
- [None]: When it is set to None, the ISM function is not performed.
- Monday-Sunday: The ISM function is performed on scheduled days and for scheduled period.

[Start Time]

- This option is available only when [Timer] is set to [Scheduling].
- Sets the start time of the ISM function.

[End Time]

- This option is available only when [Timer] is set to [Scheduling].
- Sets the end time of the ISM function.

How to Download an ISM Bar Image in Ez Download

- 1 In order to download an image in Ez Download, there must be an image file in an 'ism_bar' or 'ISM_BAR' folder on your USB storage device.
- 2 Delete the existing content stored on the internal memory before downloading a new image file.
- 3 Add "ISMBAR" as a prefix to the name of a file to distinguish the file from others (EPK, Logo, No Signal, etc.).
- 4 Download an ISM Bar Image in Ez Download.

! NOTE

- You can download multiple images up to 5 MB in total.
- The total bit size of images must be under 50 MB for the images to be downloaded.

For example, in the case of a 500 KB image with a resolution of 1920 x 1080, its bit size calculated by image decoding is about 7.91 MB ($1920 * 1080 * 32 \text{ bit} / 1024 / 1024 / 8$). Therefore, if you download 7 images of the same size, the total size of the images is about 3.5 MB, which falls within 5 MB. However, their total bit size is $7.91 \text{ MB} * 7 = 55.3 \text{ MB}$, which exceeds the maximum bit size of 50 MB, so they cannot be downloaded.

How to Download an ISM Photo/Movie in Ez Download

- 1 In order to download a user image in Ez Download, there must be a user image file in an "ism or ISM" folder on your USB storage device.
- 2 Delete the existing content stored on the internal memory before downloading a new image file.
- 3 Add [ISMPHO] as a prefix to the name of a file for photos or [ISMMOV] if the file contains movies to distinguish the file from others (EPK, Logo, No Signal, etc).
- 4 Download ISM photos or movies in Ez Download.

[Fan]

You can see the information on the internal temperature of the product and control the mounted fan.

[Mode]

- [Off]: The fan operation is disabled.
- [On]: The fan always operates.
- [Auto]: The fan operates based on the default temperature set for the product.
- [Manual]: It operates based on the user settings.

[Threshold Offset]

It indicates the difference between the temperatures at which the fan operates and stops.

[Temperature Threshold]

The temperature at which the fan installed in the product operates is set.

[Current Temperature]

It indicates the internal temperature of the product.

! NOTE

- Incorrect fan settings may cause product malfunction, so using the automatic setting is recommended.
- When the internal temperature of the set exceeds 85 °C, it is forcibly turned off to protect the set.

[Advanced Setting]

SETTINGS / ⚙️ → [General] → [Advanced Setting]

[PC/OPS Control]

- [PC/OPS Power Control]: Enable you to control the power of the OPS as you turn on/off the display.
 - [Disable]: Disable OPS Power Control.
 - [Sync (On)]: Synchronize the monitor's power status only when the monitor is on.
 - [Sync (On/Off)]: Synchronize the monitor's power status with the OPS.
- [Control Interface Selection]: This feature enables you to configure communication with the OPS connected to your monitor.
 - [Display]: Enable communication with external serial ports.
 - [OPS]: Enable communication with the OPS connected to your monitor.

[Background Image]

This feature enables you to set the default background image.

- [Booting Logo Image]: Change the logo image that appears when the device boots up. If you set this feature to [Off], the Booting Logo does not appear.
 - [Image Download]: Download Booting Logo Image files onto your monitor. In order to download a Booting Logo Image, there must be a Booting Logo Image file in a "LG_MONITOR" on your USB storage device.

! NOTE

- The feature to update the Booting Logo Image only supports JPEG files of 1 MB or smaller can be used as Booting Logo Images.
- Progressively encoded JPEG files are not applicable.
- Make sure that Booting Logo Images have a resolution suitable for the screen resolution of the monitor.
- The maximum resolution for a Booting Logo Image is Full HD (1920 x 1080) and HD (1360 x 768). The minimum resolution for a Booting Logo Image is 64 x 64.
- [No Signal Image]: Change the image that appears when there is no signal. If you set this option to [Off], no image appears when there is no signal.
 - [Image Download]: Download No Signal Image files onto your monitor. In order to download an image, there must be an No Signal Image file in a "lg_sig" or "LG_SIG" folder on your USB storage device. The maximum total size of images to be downloaded: The total size should not exceed 10240KB (10MB).

! NOTE

- The feature to update No Signal Images only supports JPEG files of 1 MB or smaller.
- Progressively encoded JPEG files are not applicable.
- The maximum resolution for a No Signal Image is Full HD (1920 x 1080) and HD (1360 x 768). The minimum resolution for a Booting Logo Image is 64 x 64.
- No Signal Image files with a resolution of Full HD (1920 x 1080) can cause image sticking.
- Only No Signal Image files with English names are displayed correctly.

[Input Manager]

Specify a label for each input source.

[SIMPLINK Setup]

- When the [SIMPLINK Setup] is set to [On], you can use the SIMPLINK provided by LG Signage.
- [Device ID]: Set the ID of the device connected via CEC wiring. You can choose a value between [All] and E.
- [Standby]: Sets the scenarios for sending and receiving the OpStandBy (0x0c) command. Detailed scenarios are as follows:

	Transmission	Reception
[All]	O	O
[Send Only]	O	X
[Receive Only]	X	O
[Off]	X	X

[Crestron]

- This function enables synchronization with applications provided by Crestron.
- [Server]: This menu sets the server's IP address for the network connection with the server (equipment provided by Crestron).
- [Port (1024-65535)]: This menu sets the port for the network connection with the server. The default port number is 41794.
- [IP ID (3-254)]: This menu sets a unique ID for synchronizing with the application.

Display

[Picture Mode Settings]

SETTINGS / ⚙️ → [Display] → [Picture Mode Settings]

[Picture Mode]

This feature enables you to choose the optimal picture mode for your installation environment.

- [Mall/QSR], [Transportation], [Education], [Gov./Corp.]: Display the picture optimally for your installation environment.
- [General]: Display the picture at normal contrast, brightness, and sharpness.
- [APS]: Adjust the screen brightness to reduce power consumption.
- [Expert], [Calibration]: Allow an expert, or anyone who loves picture quality, to manually tune to the best picture quality.

! NOTE

- The kinds of [Picture Mode] you can select may vary depending on the input signal.
- [Expert] is an option that allows a picture quality expert to fine-tune the picture quality using a specific image. Thus, it may not be effective for a normal picture.
- Return to default settings by clicking [Admin] → [Reset to Initial Settings] or [Admin] → [Factory Reset].

[Customize]

- [Backlight]: Adjust the brightness of the screen by adjusting the brightness of the backlight. The closer the value is to 100, the brighter the screen is.
- [Contrast]: Adjust the difference between the light and dark areas of the picture. The closer the value is to 100, the greater the difference is.
- [Brightness]: Adjust the overall brightness of the screen. The closer the value is to 100, the brighter the screen is.
- [Sharpness]: Adjust the sharpness of the edges of objects. The closer the value is to 50, the clearer and the sharper the edge becomes.
- [Color]: Soften or deepen the tints on the screen. The closer the value is to 100, the deeper the colors become.
- [Tint]: Adjust the balance between red and green levels displayed on the screen. The closer to Red 50, the redder the color will be. The closer to Green 50, the greener the color will be.
- [Color Temperature]: The higher you set the color temperature, the cooler the colors on the screen will feel. The lower you set the color temperature, the warmer the colors on the screen will feel.
- [Advanced Setting]: Customize the advanced options.
 - [Dynamic Contrast]: Optimize the difference between the light and dark parts of the screen according to the brightness of the image.
 - [Color Gamut]: Select the range of colors available.
 - [Dynamic Color]: Adjust the tint and saturation of the image for a more vivid and lively display.
 - [Color Filter]: Accurately adjust color and tint by filtering a specific color area of RGB space.
 - [Preferred Color]: Adjust the skin tint, grass tint, and sky tint to your preference.
 - [Gamma]: Adjust gamma settings to compensate for the brightness of the input signal.
 - [White Balance]: Adjust the overall color fidelity of the screen to your liking. In Expert mode, you can fine-tune the picture using the Method/Pattern options.
 - [Color Management System]: Experts use the color management system when they adjust the colors by using the test pattern. The color management system allows you to make an adjustment by selecting from among 6 different color spaces (Red/Yellow/Blue/Cyan/Magenta/Green) without affecting other colors. In a normal picture, you may not notice the color changes you have made.

- [Picture Option]: Customize the picture options.
 - [Noise Reduction]: Remove randomly popping dots to make the picture look clearer.
 - [MPEG Noise Reduction]: Reduce the noise generated in the process of creating a digital video signal.
 - [Black Level]: Adjust the brightness and contrast of the screen by adjusting the black level of the screen. (Recommended settings according to input signal: RGB 0–255: High, RGB 16–235: Low, YCbCr: Low)
 - [Real Cinema]: Optimize the video image for a cinematic look.
- [Apply to All Inputs]: Copies the current value of the detailed setting menu to the entire input, and applies only to the selected picture mode. Copying the detailed settings is available only for inputs set as the DTV labels.
- [Picture Reset]: Reset the picture settings. Because the picture settings are reset according to the monitor's picture mode, please select the picture mode before resetting the picture settings.
- Return to default settings by clicking [Admin] → [Reset to Initial Settings] or [Admin] → [Factory Reset].

[Aspect Ratio]

SETTINGS / ⚙️ → [Display] → [Aspect Ratio]

This feature enables you to change the picture size to view the picture at its optimal resolution.

- [Full]: Stretch the picture to fill the screen.
- [Original]: Display the picture at its original resolution.

[Rotation]

SETTINGS / ⚙️ → [Display] → [Rotation]

[OSD Rotation]

- This feature rotates the screen clockwise.
- You can set this feature to Off/90/270.
- When set to off, this feature is deactivated.
- It is recommended that you use content designed to be used in Portrait mode.

[Position]

- You can set the location of the rotated OSD as Top/Center/Bottom.

[Pivot Mode]

- This feature pivots the screen 180°.

[Advanced Setting]

SETTINGS / ⚙️ → [Display] → [Advanced Setting]

[Average Picture Level Auto Control]

- [You can use the image quality control based on APL (Average Picture Level) of the monitor input image. When using the monitor as a video wall, it is recommended to set this function off to prevent a image quality difference between the monitors.]
- Return to default settings by clicking [Admin] → [Reset to Initial Settings] or [Admin] → [Factory Reset].

[Energy Saving]

- [Smart Energy Saving]: Automatically adjust the brightness of the screen according to the brightness of the picture to save energy.
 - [On]: Enable the Smart Energy Saving feature.
 - [Off]: Disable the Smart Energy Saving feature.
 - Return to default settings by clicking [Admin] → [Reset to Initial Settings] or [Admin] → [Factory Reset].
- [Brightness Control]: Adjust the brightness of the screen to save energy.
 - [Off]: Disable the Brightness Control function.
 - [Minimum/Medium/Maximum]: Use energy saving according to the energy saving level set for the monitor.
 - [Screen Off]: Turn off the screen after 3 seconds.
 - Return to default settings by clicking [Admin] → [Reset to Initial Settings] or [Admin] → [Factory Reset].
- [Brightness Scheduling]: Adjust the backlight at specified times.
 - You can set this feature to [On]/[Off].
 - Add schedule by setting the schedule time and backlight value.
 - If the current time has not been set, [Brightness Scheduling] is disabled.
 - You can add up to six schedules, and they are sorted in ascending order by time.
 - You can delete a schedule by selecting it from the list and pressing the [OK] button.
 - Return to default settings by clicking [Admin] → [Reset to Initial Settings] or [Admin] → [Factory Reset].

Sound

[Sound Mode Settings]

SETTINGS / ⚙️ → [Sound] → [Sound Mode Settings]

[Sound Mode]

The best sound quality will be selected automatically depending on the video type currently being watched.

- [Standard]: This sound mode works well for content of all types.
- [Cinema]: Optimize sound for watching movies.
- [Clear Voice]: Enhance voices so they can be heard more clearly.
- [Sports]: Optimize sound for watching sports.
- [Music]: Optimize sound for listening to music.
- [Game]: Optimize sound for playing video games.

[Balance]

- [Balance]: Adjust the output volume for the left speaker and the right speaker.

[Equalizer]

- [Equalizer]: Manually adjust sound by using the equalizer.

[Reset]

- [Reset]: Resets sound settings.

[Audio Out]

SETTINGS / ⚙️ → [Sound] → [Audio Out]

- [Off]: Disables the use of Audio Out. (No audio outputted.)
- [Variable]: You can specify an output range for the external audio device connected to the monitor and adjust the volume within the range. You can change the volume of an external audio device within the range of 0 to 100 (the same as the Signage speaker volume). However, there may be a difference in the actual volume level outputted.
- [Fixed]: Set a fixed audio output level for the external audio device.
 - If there is no external input, no external audio is outputted.
 - The variable audio output level 100 is the same as the fixed audio output level.
- If sound noise occurs depending on the content, it can be improved by adjusting the volume of the [Variable] item.

[AV Sync Adjustment]

SETTINGS / ⚙️ → [Sound] → [AV Sync Adjustment]

This feature adjusts audio timing to synchronize video and audio.

- [Internal Monitor Speaker] (-5~15): Adjust the sync of sound from the internal speakers. Moving closer to - speeds up the audio output, while moving closer to + slows down the audio output, compared to the default value.
- [Bypass]: Output the broadcast signals or the sound from external devices without any audio delay. Audio may be outputted earlier than video due to the processing time for video that is inputted into the monitor.

[Digital Audio Input]

SETTINGS / ⚙️ → [Sound] → [Digital Audio Input]

This feature enables you to choose an input source for audio output.

- [Digital]: Output the audio contained in the digital signal inputted from the connected digital input source (HDMI, DISPLAYPORT, or OPS).
- [Analog]: Output audio from the digital input source (HDMI, DISPLAYPORT, or OPS) connected to the monitor through the Audio In port.

Admin

[Admin Lock]

SETTINGS / ⚙️ → [Admin] → [Admin Lock]

It keeps the existing settings because the Off/On button in the User menu only affects the active/inactive status of the submenu.

[Change Password]

SETTINGS / ⚙️ → [Admin] → [Change Password]

This feature enables you to set the password you use to enter the Installation menu.

- 1 Enter the current password.
- 2 Enter a new 4-digit password.
- 3 Enter the same password again in the Confirm Password field for confirmation.

[Lock Mode]

SETTINGS / ⚙️ → [Admin] → [Lock Mode]

[Home Dashboard Lock]

This feature enables you to restrict changes made to dashboard lock settings on the Home screen.

[USB Lock]

This feature restricts you from using a USB.

[OSD Lock]

This feature restricts you from using the OSD interface.

[IR Operation Lock]

- If you set this feature to [Off (Normal)], you can use your remote control.
- If you set this feature to [On (Power Key Only)], you can only use the power key.
- If you set this feature to [On (Block All)], you cannot use your remote control.

[Local Key Operation Lock]

- This feature enables you to configure the Local Key Operation Lock feature so that settings or content cannot be changed.
- If you set this feature to [Off (Normal)], you can use the local keys on the monitor.
- If you set this feature to [On (Power Key Only)], you can only use the power key.
- If you set this feature to [On (Block All)], you cannot use the local keys.

! NOTE

- If [IR Operation Lock] and [Local Key Operation Lock] are both set to [On (Block All)], [General] > [Power] > [Power On Status] value switches to 'PWR'. Changing this value is not impossible to ensure the correct powering on operation. (To prevent mistakes by the user)
- If [IR Operation Lock] is set to [On] (Power Key Only, Block All), you can go to the menu screen by pressing and holding the Settings key for more than 5 seconds and entering the password.

[Reset to Initial Settings]

SETTINGS / ⚙️ → [Admin] → [Reset to Initial Settings]

Reset all data except for the items (languages, screen direction, inputs, time and power)

[Ez Download]

SETTINGS / ⚙️ → [Admin] → [Ez Download]

Users can easily download Software Update, Logo Image, No Signal Image, Data Cloning and etc. from Ez Download.

[Factory Reset]

SETTINGS / ⚙️ → [Admin] → [Factory Reset]

This feature resets the items applicable for Reset to Initial Settings, Date, Time, Language, Network IP, and the Input Label Internal Storage files.

However, Calibration mode's RGB gain is an exception.

Picture ID

- This only applies to certain models.

[Picture ID] is used to change the settings of a specific set (display) using a single IR receiver for multi-vision.

Communication is possible between a monitor with an IR receiver and other monitors using RS-232C cables. Each monitor is identified by a Set ID. Setting [Picture ID] allows you to only use the remote control with monitors with a [Set ID] that matches the [Picture ID].

- 1 Assign [Set ID] to the installed monitors as shown below:

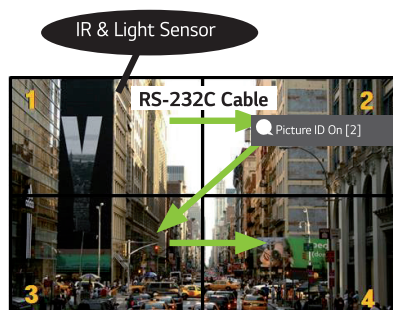

- 2 Press the red [Picture ID] [On] button on the remote control.

- 3 Make sure that the Picture ID you set is identical to the [Set ID] of the monitor you wish to control.

- A set with a [Set ID] that is different from the [Picture ID] cannot be controlled by IR signals.

! NOTE

- If [Picture ID] has been set to 2, only the upper right monitor, which has a [Set ID] of 2, can be controlled by IR signals.
- If you press the green [Picture ID] [Off] button on your remote control, the [Picture ID] for all monitors are turned off. If you then press any button on the remote control, all monitors can be controlled by IR signals regardless of their [Set ID]s.

CONTENT MANAGER

Content Manager

[Player]

HOME /  →  ([Player])

The Content Manager app's player feature enables you to play video content, image content, template content and playlist content in an integrated way.

[Play]

- 1 Select your desired type of content from the tab on the left and then select your desired content.
- 2 Click [Play] in the upper right-hand corner of the screen and enjoy the content you have selected.

[Scheduler]

HOME /  →  ([Scheduler])

The Content Manager app's scheduler feature enables certain content to be played at a scheduled time through a playlist or external input.

[Creating a Schedule]

- 1 Click [Add New Schedule] in the upper right-hand corner of the screen.
- 2 Choose between [Playlist] and [Input].
- 3 1) If you have selected [Playlist], select the playlist you wish to schedule the playback of.
 - 1-1) You can cancel schedule creation by clicking the Cancel button.
 - 2) If you have selected [Input], select the external input source you wish to schedule the playback of.
 - 2-1) You can cancel schedule creation by clicking the Cancel button.
- 4 Enter schedule information and create a new schedule.
 - 1) You can go back to the [Playlist] / [Inputs] screen by clicking the Back button.
 - 2) You can go back to the Scheduler screen by clicking the Cancel button.
- 5 Watch the playlist or external input you selected play back at its scheduled time.

[Deleting a Schedule]

- 1 Click [Delete] in the upper right-hand corner of the screen.
- 2 Select the schedules you wish to delete.
- 3 Click [Delete].
- 4 Check that the schedules have been deleted.

[Playing a Schedule Now]

- 1 On the Scheduler screen, select the schedule you wish to play.
- 2 After selecting the desired schedule, select [Play Now] on the bottom right corner of the screen.
- 3 Watch the playlist or external input you selected plays back.

[Editing a Schedule]

- 1 On [Scheduler], select the schedule you wish to edit.
- 2 After selecting the desired schedule, select [Edit] on the bottom right corner of the screen.
- 3 If the selected schedule is a playlist, playlist edit window will appear. If it is an external input, external input edit window will appear. Select the [Playlist] / [Input] you wish to edit.
 - 1) You can cancel schedule editing by clicking the Cancel button.
- 4 Enter schedule information to edit a schedule.
 - 1) You can go back to the [Playlist] / [Inputs] screen by clicking the Back button.
 - 2) You can go back to the Scheduler screen by clicking the Cancel button.
- 5 Check the edited Scheduler.
- 6 Watch the playlist or external input you selected play back at its scheduled time.

! NOTE

- When creating and editing a schedule, you cannot include characters that cannot be used in file names on Windows — such as \, /, ;, *, ?, ", <, >, and | — in the name of the schedule file. You cannot create a schedule if file names include such characters.
- In addition, if the playlist linked to the schedule contains content files whose names include such characters, you cannot move or copy the playlist.
- If the schedule creation time overlaps, the previously created schedule is deleted.
- If there is an existing schedule with the same name, change the name to create a schedule.
- Schedule does not work while Scheduling list app is running.

[Playlist]

HOME /  →  ([Playlist])

This feature creates playlist using content in a USB and automatically plays back the created playlist when the monitor is turned on.

Create Playlist

- 1 Click [Create New Playlist] in the upper right-hand corner of the screen.
- 2 Select the desired content and click [Complete].
- 3 Check the created playlist.

[Power On Play] Setting

- 1 Click [Power On Play] in the upper right-hand corner of the screen.
- 2 Select the desired playlist and click [Complete].
- 3 Check the selected playlist play back when the monitor is turned on.

[Delete Playlist]

- 1 Click [Delete] in the upper right-hand corner of the screen.
- 2 Select the desired playlists and click [Delete].
- 3 Check that the playlists have been deleted.

Photo Playback Speed Setting

- 1 Click [Settings] in the upper right-hand corner of the screen.
- 2 Select the desired time and click [Save]. (You can set this feature to 5/10/20/30.)
- 3 Check the playback speed when the playlist plays back.

[Edit Playlist]

- 1 Select the playlist you wish to edit.

Add Content

- 1 Click [Add Content] in the upper right-hand corner of the screen.
- 2 Select the desired content and click [Complete].
- 3 Check that the content has been added.

Change Content Order

- 1 Click [Change Order] in the upper right-hand corner of the screen.
- 2 Select and move the desired content.
- 3 After moving the content to the desired location, click [Complete].
- 4 Check that the content order has been changed.

Delete Content

- 1 Click [Delete] in the upper right-hand corner of the screen.
- 2 Select the desired content and click [Delete].
- 3 Check that the content has been deleted.

Supported Media File Formats

Supported Video File Formats

- Maximum data transfer rate: 20 Mbps (Megabits per second)
- Maximum supported resolution: 1920 x 1080 @ 30p (only Motion JPEG 640 x 480 @ 30p)

Extension	Codec	
.asf, .wmv	Video	MPEG-4 Part2, Xvid, H.264/AVC, VC1(WMV3, WVC1), MP43
	Audio	WMA Standard, WMA9(Pro), MP3, AAC, AC3
.avi	Video	MPEG-2, MPEG-4 Part2, Xvid, H.264/AVC
	Audio	HE-AAC, LPCM, ADPCM, MPEG-1 Layer I, MPEG-1 Layer II, Dolby Digital, MPEG-1 Layer III (MP3)
.ts, .trp, .tp, .mts, .m2ts	Video	H.264/AVC, MPEG-2, H.265/HEVC
	Audio	MPEG-1 Layer I, MPEG-1 Layer II, MPEG-1, Layer III (MP3), Dolby Digital, Dolby Digital, Plus, AAC, HE-AAC
.vob	Video	MPEG-1, MPEG-2
	Audio	Dolby Digital, MPEG-1 Layer I, MPEG-1, Layer II, DVD-LPCM
.mp4, .m4v, .mov	Video	MPEG-2, MPEG-4 Part2, Xvid, H.264/AVC
	Audio	AAC, MPEG-1 Layer III (MP3)
.mkv	Video	MPEG-2, MPEG-4 Part2, Xvid, H.264/AVC
	Audio	HE-AAC, Dolby Digital, MPEG-1 Layer III (MP3), LPCM
motion JPEG	Video	MJPEG
	Audio	LPCM, ADPCM
.mpg, .mpeg, .mpe	Video	MPEG-1, MPEG-2
	Audio	MPEG-1 Layer I, MPEG-1 Layer II, Dolby Digital, LPCM
.dat	Video	MPEG-1, MPEG-2
	Audio	MP2
.flv	Video	Sorenson H.263, H.264/AVC
	Audio	MP3, AAC, HE-AAC
.3gp	Video	H.264/AVC, MPEG-4 Part2
	Audio	AAC, AMR(NB/WB)

! NOTE

- Dolby is not supported for a specific model such as 49KE5E.

Supported Photo File Formats

File type	Format	Resolution
.jpeg, .jpg, .jpe	Supported file format	SOF0: Baseline SOF1: Extend Sequential SOF2: Progressive
	Photo size	Minimum: 64 (W) x 64 (H) Maximum: Normal Type: 15360 (W) x 8640 (H) Progressive Type: 1920 (W) x 1440 (H)
.png	Supported file format	Interlace, Non-Interlace
	Photo size	Minimum: 64 (W) x 64 (H) Maximum: Interlace: 1200 (W) x 800 (H) Non-Interlace: 9600 (W) x 6400 (H)
.bmp	Photo size	Minimum: 64 (W) x 64 (H) Maximum: 9600 (W) x 6400 (H)

Supported Music File Formats

File type	Format	Info
MP3	Bit rate	32 Kbps - 320 Kbps
	Sample freq.	16 kHz - 48 kHz
	Support	MPEG-1, MPEG-2, Layer2, Layer3
AAC	Bit rate	Free Format
	Sample freq.	8 kHz - 48 kHz
	Support	ADIF, ADTS
M4A	Bit rate	Free Format
	Sample freq.	8 kHz - 48 kHz
	Support	MPEG-4
WAV	Bit rate	64 kbps - 1.5 Mbps
	Sample freq.	8 kHz - 48 kHz
	Support	LPCM
	Bit depth	8 bit / 16 bit / 24 bit
WMA	Bit rate	128 Kbps - 320 Kbps
	Sample freq.	8 kHz - 48 kHz
	Support	WMA7, WMA8, WMA9 Standard
WMA 10 Pro	Bit rate	- 768 Kbps
	Sample freq.	M0: up to 2 Channel @ 48 kHz (Except LBR mode) M1: up to 5.1 Channel @ 48 kHz M2: up to 5.1 Channel @ 96 kHz
	Support	WMA 10 Pro
OGG	Bit rate	Free Format
	Sample freq.	8 kHz - 48 kHz
	Support	OGG Vorbis

 **NOTE**

- The playback speed of BMP and PNG files can be slower than JPEG.









Tips for using USB storage devices

- Only USB storage devices are recognized.
- USB storage devices connected to the monitor through a USB hub may not work properly.
- USB storage devices that use an automatic recognition program may not be recognized.
- USB storage devices that use their own drivers may not be recognized.
- The recognition speed of a USB storage device may depend on each device.
- Please do not turn off the display or unplug the USB device when the connected USB storage device is working. When the device is suddenly separated or unplugged, the stored files or the USB storage device may be damaged.
- Please do not connect the USB storage device which was artificially maneuvered on the PC. The device may cause the product to malfunction or fail to be played. Remember to only use USB storage devices that store normal music, image, and/or movie files.
- Storage devices formatted with utility programs that are not supported by Windows may not be recognized.
- Please connect power to a USB storage device (over 0.5 A) which requires an external power supply. Otherwise, the device may not be recognized.
- Please connect a USB storage device with the cable offered by the device maker.
- Some USB storage devices may not be supported or operated smoothly.
- Some models do not support USB external hard disks.
- File alignment methods of the USB storage device is similar to Windows XP and filenames can include up to 100 English characters.
- Be sure to back up important files since data stored in a USB memory device may be damaged. We will not be responsible for any data loss.
- If the USB HDD does not have an external power source, the USB device may not be detected. So make sure to connect it to an external power source.
 - Please use a power adapter for an external power source. No USB cable is provided for an external power source.

- If your USB storage device has multiple partitions, or if you use a USB multi-card reader, you can use up to four partitions or USB memory devices.
- If a USB storage device is connected to a USB multi-card reader, its volume data may not be detected.
- If the USB storage device does not work properly, remove it and connect it again.
- The speed at which a USB storage device is detected differs from device to device.
- If the USB storage device is connected in Standby Mode, a specific hard disk will automatically be loaded when the display is turned on.
- The recommended capacity is 1 TB or less for a USB external hard disk and 32 GB or less for USB memory.
- Any device with more than the recommended capacity may not work properly.
- If a USB external hard disk with an energy saving feature does not work, turn the hard disk off and on again to make it work properly.
- USB storage devices (USB 2.0 or below) are also supported. However, they may not work properly in the videos list.
- A maximum of 999 folders or files can be recognized under one folder.
- Only use USB storage devices that have been formatted with the FAT32 file system. Storage devices formatted with utility programs that are not supported by Windows may not be recognized.
- USB 3.0 may not work properly.
- For some USB storage devices, data may be damaged under high temperature.
- Playing back content using 2 or more USB ports is not recommended.

IR CODE

- All models do not support the HDMI/USB function.
- Some key codes may not be supported depending on the model.

Code (Hex)	Function	Remarks
08	 (Power)	Remote control button
C4	MONITOR ON (Monitor On)	Remote control button
C5	MONITOR OFF (Monitor Off)	Remote control button
95	 (Energy Saving)	Remote control button
0B	INPUT (Select input)	Remote control button
10	Number Key 0	Remote control button
11	Number Key 1	Remote control button
12	Number Key 2	Remote control button
13	Number Key 3	Remote control button
14	Number Key 4	Remote control button
15	Number Key 5	Remote control button
16	Number Key 6	Remote control button
17	Number Key 7	Remote control button
18	Number Key 8	Remote control button
19	Number Key 9	Remote control button
02	 (Vol +)	Remote control button
03	 (Vol -)	Remote control button
E0	BRIGHTNESS (Brightness)  (Page Up)	Remote control button
E1	BRIGHTNESS (Brightness)  (Page Down)	Remote control button
DC	 (3D)	Remote control button
32	1/a/A	Remote control button
2F	CLEAR	Remote control button
7E	 SIMPLINK	Remote control button
79	ARC (Aspect Ratio)	Remote control button
4D	PSM (Picture Mode)	Remote control button
09	 (MUTE)	Remote control button

Code (Hex)	Function	Remarks
43	⚙️ (Settings/Menu)	Remote control button
99	Auto Configuration	Remote control button
40	⤴️ (Up)	Remote control button
41	⤵️ (Down)	Remote control button
06	⤶️ (Right)	Remote control button
07	⤷️ (Left)	Remote control button
44	Ⓞ ok (OK)	Remote control button
28	↶️ (BACK)	Remote control button
7B	TILE (Tile)	Remote control button
5B	EXIT (Exit)	Remote control button
72	Picture ID On (red)	Remote control button
71	Picture ID Off (green)	Remote control button
63	Yellow	Remote control button
61	Blue	Remote control button
B1	■	Remote control button
B0	▶️	Remote control button
BA	⏸️	Remote control button
BF	◀️	Remote control button
BE	▶️	Remote control button
AA	INFO ⓘ	Remote control button
5F	W.Bal	Remote control button
3F	⌘ (S.Menu)	Remote control button
7C	🏠 (Home)	Remote control button

CONTROLLING MULTIPLE PRODUCTS

- This only applies to certain models.

Use this method to connect several products to a single PC. You can control several products at a time by connecting them to a single PC.

In the Option menu, the Set ID must be between 1 and 1000 without being duplicated.

Connecting cables

- The image may be different according to the model.

Connect the RS-232C cable as shown in the picture.

The RS-232C protocol is used for communication between the PC and product. You can turn the product on/off, select an input source and adjust the OSD menu from your PC.

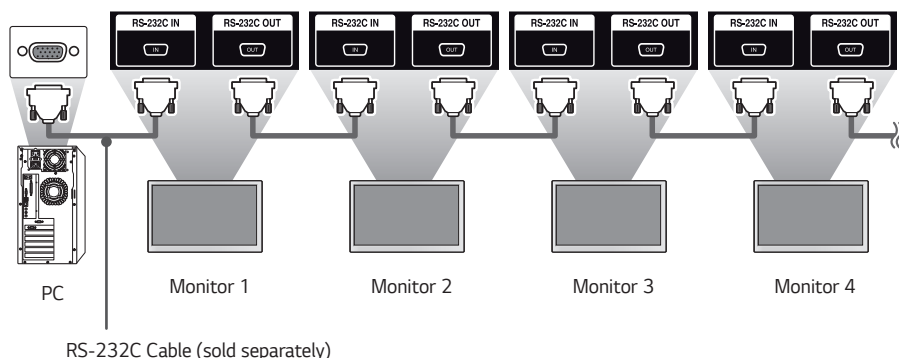
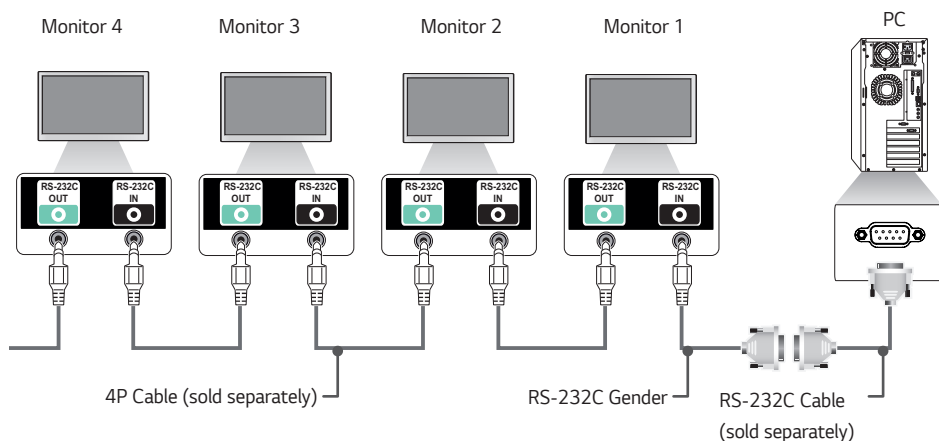

Communication Parameter

Baud Rate: 9600 bps
 Data Length: 8 bits
 Parity Bit: None
 Stop Bit: 1 bit
 Flow Control: None
 Communication Code: ASCII

! NOTE

- When using 3-wire connections (non-standard), an IR daisy chain cannot be used.
- Be sure to only use the provided gender to connect properly.
- When you have daisy-chained multiple Signage products to control them simultaneously, if you attempt to turn on/off the master device in a continuous manner, some products may not turn on. In this case, you can turn those monitors on by pressing the **MONITOR ON** button, not the Power button.

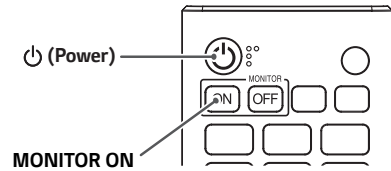

Command Reference List

		Command		Data (Hexadecimal)
		1	2	
01	[Power]	k	a	00 to 01
02	Select Input	x	b	See Select Input
03	[Aspect Ratio]	k	c	See [Aspect Ratio]
04	[Brightness Control]	j	q	See [Energy Saving]
05	[Picture Mode]	d	x	See [Picture Mode]
06	[Contrast]	k	g	00 to 64
07	[Brightness]	k	h	00 to 64
08	[Sharpness]	k	k	00 to 32
09	[Color]	k	i	00 to 64
10	[Tint]	k	j	00 to 64
11	[Color Temperature]	x	u	70 to D2
12	[Balance]	k	t	00 to 64
13	[Sound Mode]	d	y	See [Sound Mode]
14	[MUTE]	k	e	00 to 01
15	Volume Control	k	f	00 to 64
16	Clock 1 (year/month/day)	f	a	See [Clock 1]
17	Clock 2 (hour/minute/second)	f	x	See [Clock 2]
18	[Daylight Saving Time]	s	d	See [Daylight Saving Time]
19	[Auto Power Off]	f	g	00 to 01
20	[No IR Power Off]	m	n	00 to 04
21	[Language]	f	i	See [Language]
22	Set Default	f	k	00 to 02
23	Current Temperature	d	n	FF
24	Key	m	c	See Key
25	Time Elapsed	d	l	FF

		Command		Data (Hexadecimal)
		1	2	
26	Check product serial number	f	y	FF
27	Software Version	f	z	FF
28	[White Balance] Red Gain	j	m	00 to FE
29	[White Balance] Green Gain	j	n	00 to FE
30	[White Balance] Blue Gain	j	o	00 to FE
31	[White Balance] Red Offset	s	x	00 to 7F
32	[White Balance] Green Offset	s	y	00 to 7F
33	[White Balance] Blue Offset	s	z	00 to 7F
34	[Backlight]	m	g	00 to 64
35	[Screen Off]	k	d	00 to 01
36	[Tile Mode]	d	d	00 to FF
37	Check [Tile Mode]	d	z	FF
38	[Tile ID]	d	i	See [Tile ID]
39	[Natural Mode] (In Tile Mode)	d	j	00 to 01
40	Tile H Position	d	e	00 to 32
41	Tile V Position	d	f	00 to 32
42	Tile H Size	d	g	00 to 32
43	Tile V Size	d	h	00 to 32
44	DPM Mode Settings	f	j	00 to 07
45	[DPM Wake Up Control]	s	n, 0b	00 to 01
46	Remote Control/[Local Key Operation Lock]	k	m	00 to 01
47	[Power On Delay]	f	h	00 to FA
48	Select [Fail Over] Mode	m	i	00 to 02
49	Select [Fail Over] Input	m	j	See Select [Fail Over] Input
50	Remote Control Key Lock	t	p	00 to 02

		Command		Data (Hexadecimal)
		1	2	
51	[Local Key Operation Lock]	t	o	00 to 02
52	Status Check	s	v	See Status Check
53	[Screen Fault Detection]	t	z	00 to 01
54	[PM Mode]	s	n, 0c	00 to 04
55	[Screen Off Always]	s	n, 0d	00 to 01
56	[Auto Config.]	j	u	01
57	[Digital Audio Input]	s	n, 04	00 to 01
58	[Audio Out]	s	n, aa	00 to 02
59	[OSD Rotation]	t	h	00 to 02
60	[Pivot Mode]	t	a	00 to 01
61	[Brightness Scheduling] Mode	s	m	00 to 01
62	[Brightness Scheduling]	s	s	See [Brightness Scheduling]
63	[Contents Sync]	t	g	00 to 01
64	[Time Sync] Settings	s	n, 16	00 to 18
65	Timer Power On Scheduling	f	b	00 to 01
66	Timer Power Off Scheduling	f	c	00 to 01
67	[Timer Power Off] (Repeat Mode / Time)	f	e	See [Timer Power Off]
68	[Timer Power On] (Repeat Mode / Time)	f	d	See [Timer Power On]
69	[Holiday Setting] Mode	s	n, 1a	00 to 01
70	[Holiday Setting]	s	n, 1b	See [Holiday Setting]
71	[Power On Status]	t	r	00 to 02
72	[Wake On LAN]	f	w	00 to 01
73	[ISM Method]	j	p	See [ISM Method]
74	[Booting Logo Image]	s	n, a3	00 to 01
75	[No Signal Image]	s	n, a9	00 to 01

		Command		Data (Hexadecimal)
		1	2	
76	H Position	f	q	00 to 64
77	V Position	f	r	00 to 64
78	H Size	f	s	00 to 64
79	[Home Dashboard Lock]	s	n, 9d	00 to 01
80	[USB Lock]	s	n, 9e	00 to 01
81	[OSD Lock]	k	l	00 to 01
82	[Change Password]	s	n, a7	See [Change Password]
83	[Apply to all inputs]	s	n, 52	01
84	OSD Location	s	n, ac	00 to 02
85	Fail Over USB Input	s	n, 0a	00 to 02
86	Check Fan Failure	d	w	00 to 01
87	[Network Settings]	s	n, 80(81)(82)	See [Network Settings]
88	[Natural Size]	s	n, a5	00 to 64
89	[Threshold Offset]	s	n, b4	00 to 15
90	[Temperature Threshold]	s	n, b5	14 to 55

NOTE

- Commands may not work when there is no external input used.
- Some commands may not be supported on some models.
- During USB operations such as DivX or EMF, all commands except Power (ka) and Key (mc) are not executed and treated as NG.

Transmission/Reception Protocol

Transmission

(Command1)(Command2)()(Set ID)()(Data)(Cr)

- * (Command1): Identifies between the factory setting and the user setting modes.
- * (Command2): This command is used to control the monitor.
- * (Set ID): Used for selecting a set you want to control. A unique Set ID can be assigned to each set ranging from 1 to 255 (01H to FFH) or from 1 to 1000 (001H to 3e8H) under Settings in the OSD menu. Selecting '00H' or '000H' for Set ID allows the simultaneous control of all connected monitors (The maximum value may differ depending on the model.)
- * (Data): Transmits command data. Data count may increase depending on the command.
- * (Cr): Carriage Return. This parameter corresponds to '0 x 0D' in ASCII code.
- * (): White Space. This parameter corresponds to '0 x 20' in ASCII code.

Acknowledgment

(Command2)()(Set ID)()(OK/NG)(Data)(x)

- * The product transmits an ACK (acknowledgment) based on this format when receiving normal data. At this point, if the data is FF, it indicates the present status data. If the data is in data write mode, it returns the data of the PC computer.
- * If a command is sent with Set ID '00' (=0 x 00) or '000' (= 0 x 000), the data is reflected to all monitors and they do not send an acknowledgment (ACK).
- * If you send "FF" as the value of the data in control mode via RS-232C, you can check the value currently set for the relevant feature (not applicable to some features)
- * Some commands may not be supported on some models.

01. [Power] (Command: k a)

Controls the power on/off status of the monitor.

Transmission**(k)(a)() (Set ID)() (Data)(Cr)**Data 00: Off
01: On**Acknowledgment****(a)() (Set ID)() (OK/NG)(Data)(x)**

- * The Acknowledgment signal is returned properly only when the monitor is fully powered on.
- * There may be a delay between the Transmission and Acknowledgment signals.
- * This feature may not be available for all models.

02. Select Input (Command: x b)

Selects an input signal.

Transmission**(x)(b)() (Set ID)() (Data)(Cr)**Data 20: AV
40: Component
60: RGB
70: DVI-D (PC)
80: DVI-D (DTV)
90: HDMI (HDMI1) (DTV)
A0: HDMI (HDMI1) (PC)
91: HDMI2/OPS (DTV)
A1: HDMI2/OPS (PC)
C0: DISPLAYPORT (DTV)
D0: DISPLAYPORT (PC)
98: OPS (DTV)
A8: OPS (PC)**Acknowledgment****(b)() (Set ID)() (OK/NG)(Data)(x)**

- * Some input signals may not be available for all models.

03. [Aspect Ratio] (Command: k c)

Adjusts the aspect ratio of your monitor.

Transmission**(k)(c)() (Set ID)() (Data)(Cr)**Data 02: [Full Screen]
06: [Original]**Acknowledgment****(c)() (Set ID)() (OK/NG)(Data)(x)**

- * The aspect ratio may differ depending on the model's input configuration.

04. [Power Saving] (Command: j q)

Configures the Power Saving mode.

Transmission**(j)(q)() (Set ID)() (Data)(Cr)**Data 00: [Off]
01: [Minimum]
02: [Medium]
03: [Maximum]
05: [Screen Off]**Acknowledgment****(q)() (Set ID)() (OK/NG)(Data)(x)**

- * This feature may not be available for all models.

05. [Picture Mode] (Command: d x)

Selects a picture mode.

Transmission**(d)(x)() (Set ID)() (Data)(Cr)**Data 00: [Mall/QSR]
01: [General]
02: [Gov./Corp.]
03: [Transportation]
04: [Education]
05: [Expert] (Expert 1)
06: [Expert] (Expert 2)
08: [APS]
11: [Calibration]**Acknowledgment****(x)() (Set ID)() (OK/NG)(Data)(x)**

- * Some picture modes may not be available for all models.

06. [Contrast] (Command: k g)

Adjusts the screen contrast.

Transmission**(k)(g)() (Set ID)() (Data)(Cr)**

Data 00-64: Contrast 0-100

Acknowledgment**(g)() (Set ID)() (OK/NG)(Data)(x)**

07. [Brightness] (Command: k h)

Adjusts the screen brightness.

Transmission**(k)(h)() (Set ID)() (Data)(Cr)**

Data 00-64: Brightness 0-100

Acknowledgment**(h)() (Set ID)() (OK/NG)(Data)(x)****08. [Sharpness] (Command: k k)**

Adjusts the screen sharpness.

Transmission**(k)(k)() (Set ID)() (Data)(Cr)**

Data 00-32: Sharpness 0-50

Acknowledgment**(k)() (Set ID)() (OK/NG)(Data)(x)****09. [Color] (Command: k i)**

Adjusts the screen colors.

Transmission**(k)(i)() (Set ID)() (Data)(Cr)**

Data 00-64: Color 0-100

Acknowledgment**(i)() (Set ID)() (OK/NG)(Data)(x)****10. [Tint] (Command: k j)**

Adjusts the screen tints.

Transmission**(k)(j)() (Set ID)() (Data)(Cr)**

Data 00-64: Tint Red 50-Green 50

Acknowledgment**(j)() (Set ID)() (OK/NG)(Data)(x)****11. [Color Temperature] (Command: x u)**

Adjusts the screen color temperature.

Transmission**(x)(u)() (Set ID)() (Data)(Cr)**

Data 70-D2: 3200K-13000K

Acknowledgment**(u)() (Set ID)() (OK/NG)(Data)(x)**

* The range of color temperature may be different on some models.

12. [Balance] (Command: k t)

Adjusts the sound balance.

Transmission**(k)(t)() (Set ID)() (Data)(Cr)**

Data 00-64: Left 50-Right 50

Acknowledgment**(t)() (Set ID)() (OK/NG)(Data)(x)**

* This feature may not be available for all models.

13. [Sound Mode] (Command: d y)

Selects a sound mode.

Transmission**(d)(y)() (Set ID)() (Data)(Cr)**

Data 01: [Standard]

02: [Music]

03: [Cinema]

04: [Sports]

05: [Game]

07: [Clear Voice]

Acknowledgment**(y)() (Set ID)() (OK/NG)(Data)(x)**

* This feature may not be available for all models.

14. [Mute] (Command: k e)

Mutes/unmutes audio.

Transmission**(k)(e)()(Set ID)()(Data)(Cr)**Data 00: Mute on (Volume off)
01: Mute off (Volume on)**Acknowledgment****(e)()(Set ID)()(OK/NG)(Data)(x)**

- * This feature may not be available for all models.

15. Volume Control (Command: k f)

Adjusts the playback volume.

Transmission**(k)(f)()(Set ID)()(Data)(Cr)**

Data 00-64: Volume 0-100

Acknowledgment**(f)()(Set ID)()(OK/NG)(Data)(x)**

- * This feature may not be available for all models.

16. Clock 1 (year/month/day) (Command: f a)

Sets the Clock 1 (year/month/day) values and Auto Time.

Transmission

- (f)(a)()(Set ID)()(Data1)()(Data2)()(Data3)(Cr)**
- (f)(a)()(Set ID)()(0)(0)()(Data1)(Cr)**

1. When setting Clock 1 (year/month/day)

Data1 00-: 2010 -
Data2 01-0C: January - December
Data3 01-1F: 1-31

- * The minimum and maximum values for Data1 differ depending on the product's release year.
- * Enter "fa [Set ID] ff" to view Clock 1 (year/month/day) settings.
- 2. When Setting Auto Time
- Data1 00: [Auto]
01: [Manual]
- * To view the set value of the Auto time, enter "fa [Set ID] 00 ff".

Acknowledgment

- (a)()(Set ID)()(OK/NG)(Data1)(Data2)(Data3)(x)**
- (a)()(Set ID)()(OK/NG)(0)(0)(Data1)(x)**

17. Clock 2 (Hour/Minute/Second) (Command: f x)

Sets the Clock 2 values (hour/minute/second).

Transmission**(f)(x)()(Set ID)()(Data1)()(Data2)()(Data3)(Cr)**Data1 00-17: 00-23 hours
Data2 00-3B: 00-59 minutes
Data3 00-3B: 00-59 seconds

- * Enter "fx [Set ID] ff" to view the Time 2 (hour/minute/second) settings.
- * This feature is only available when Clock 1 (year/month/day) has been set.

Acknowledgment**(x)()(Set ID)()(OK/NG)(Data1)(Data2)(Data3)(x)****18. [Daylight Saving Time] (Command: s d)**

Sets Daylight Savings Time.

Transmission**(s)(d)()(Set ID)()(Data1)()(Data2)()(Data3)()(Data4)()(Data5)()(Cr)**Data1 00: Off (Data2-5: FF)
01: Start Time
02: End Time
Data2 01-0C: January - December
Data3 01-06: Week 1 - 6
Data4 00-06: (Sunday - Saturday)
Data5 00-17: 00 - 23 hours

- * The maximum value of [Data3] may vary depending on the date.

If you wish to read the start/end times, enter FF for parameters [Data2] through [Data5].
(Example 1: sd 01 01 ff ff ff ff - Checks the start time.
Example 2: sd 01 02 ff ff ff ff - Checks the end time.)

- * This feature only works when Clock 1 (year/month/day) and Clock 2 (hour/minute/second) have been set.

Acknowledgment**(d)()(Set ID)()(OK/NG)(Data1)(Data2)(Data3)(Data4)(Data5)(x)**

- * This feature may not be available for all models.

19. [No Signal Power Off] (Command: f g)

Sets the No Signal Power Off function.

Transmission**(f)(g)() (Set ID)() (Data)(Cr)**Data 00: Off (Not turned off after 15 minutes)
01: On (Turned off after 15 minutes)**Acknowledgment****(g)() (Set ID)() (OK/NG)(Data)(x)****20. [No IR Power Off] (Command: m n)**

Activates Auto Power Off when there is no IR signal.

Transmission**(m)(n)() (Set ID)() (Data)(Cr)**Data 00: Off (Not turned off after 2/4/6/8 hours)
01: 2 hours (Turned off after 2 hours)
02: 4 hours (Turned off after 4 hours)
03: 6 hours (Turned off after 6 hours)
04: 8 hours (Turned off after 8 hours)**Acknowledgment****(n)() (Set ID)() (OK/NG)(Data)(x)****21. [Language] (Command: f i)**

Sets the OSD language.

Transmission**(f)(i)() (Set ID)() (Data)(Cr)**Data 00: Czech
01: Danish
02: German
03: English
04: Spanish (Europe)
05: Greek
06: French
07: Italian
08: Dutch
09: Norwegian
0A: Portuguese
0B: Portuguese (Brazil)
0C: Russian
0D: Finnish
0E: Swedish
0F: Korean
10: Chinese (Cantonese)
11: Japanese
12: Chinese (Mandarin)
13: Arabic**Acknowledgment****(i)() (Set ID)() (OK/NG)(Data)(x)**

* Some languages may not be available for all models.

22. Initial Value Settings (Command: f k)

Executes Reset.

(Initialize Screen can only be executed in RGB input mode.)

Transmission**(f)(k)() (Set ID)() (Data)(Cr)**Data 00: [Picture Reset]
01: Initialize Screen
02: [Reset to Initial Settings]**Acknowledgment****(k)() (Set ID)() (OK/NG)(Data)(x)**

* This feature may not be available for all models.

23. Current Temperature (Command: d n)

Checks the current temperature of the product.

Transmission**(d)(n)() (Set ID)() (Data)(Cr)**

Data FF: Status Check

Acknowledgment**(n)() (Set ID)() (OK/NG)(Data)(x)**

* The temperature is displayed in hexadecimal.

24. Key (Command: m c)

Sends a key code for the IR remote control.

Transmission**(m)(c)() (Set ID)() (Data)(Cr)**

Data IR_KEY_CODE

Acknowledgment**(c)() (Set ID)() (OK/NG)(Data)(x)**

* For key codes, see IR Codes.

* Some key codes may not be supported depending on the model.

25. Time Elapsed (Command: d l)

Displays the time that has elapsed after your monitor has turned on.

Transmission

(d)(l)()(Set ID)()(Data)(Cr)

Data FF: Read status

Acknowledgment

(l)()(Set ID)()(OK/NG)(Data)(x)

* The data received is displayed in hexadecimal.

26. Product Serial Number Check (Command: f y)

Checks the serial number of the product.

Transmission

(f)(y)()(Set ID)()(Data)(Cr)

Data FF: Check product serial number

Acknowledgment

(y)()(Set ID)()(OK/NG)(Data)(x)

* Data is in ASCII format.

27. Software Version (Command: f z)

Checks the software version of the product.

Transmission

(f)(z)()(Set ID)()(Data)(Cr)

Data FF: Check the software version

Acknowledgment

(z)()(Set ID)()(OK/NG)(Data)(x)

28. [White Balance] Red Gain (Command: j m)

Adjusts the red gain value for white balance.

Transmission

(j)(m)()(Set ID)()(Data)(Cr)

Data 00-FE: Red Gain 0-254

FF: Checks red gain value

Acknowledgment

(m)()(Set ID)()(OK/NG)(Data)(x)

29. [White Balance] Green Gain (Command: j n)

Adjusts the green gain value for white balance.

Transmission

(j)(n)()(Set ID)()(Data)(Cr)

Data 00-FE: Green Gain 0-254

FF: Checks green gain value

Acknowledgment

(n)()(Set ID)()(OK/NG)(Data)(x)

30. [White Balance] Blue Gain (Command: j o)

Adjusts the blue gain value for white balance.

Transmission

(j)(o)()(Set ID)()(Data)(Cr)

Data 00-FE: Blue Gain 0-254

FF: Checks blue gain value

Acknowledgment

(o)()(Set ID)()(OK/NG)(Data)(x)

31. [White Balance] Red Offset (Command: s x)

Adjusts the red offset value for white balance.

Transmission

(s)(x)()(Set ID)()(Data)(Cr)

Data 00-7F: Red Offset 0-127

FF: Checks red offset value

Acknowledgment

(x)()(Set ID)()(OK/NG)(Data)(x)

32. [White Balance] Green Offset (Command: s y)

Adjusts the green offset value for white balance.

Transmission

(s)(y)()(Set ID)()(Data)(Cr)

Data 00-7F: Green Offset 0-127

FF: Checks green offset value

Acknowledgment

(y)()(Set ID)()(OK/NG)(Data)(x)

33. [White Balance] Blue Offset (Command: s z)

Adjusts the blue offset value for white balance.

Transmission

(s)(z)()(Set ID)()(Data)(Cr)

Data 00-7F: Blue Offset 0-127
FF: Checks blue offset value

Acknowledgment

(z)()(Set ID)()(OK/NG)(Data)(x)

34. [Backlight] (Command: m g)

Adjusts the backlight brightness.

Transmission

(m)(g)()(Set ID)()(Data)(Cr)

Data 00-64: Backlight 0-100

Acknowledgment

(g)()(set ID)()(OK/NG)(Data)(x)

* This feature may not be available for all models.

35. [Screen Off] (Command: k d)

Turns off/off the screen.

Transmission

(k)(d)()(Set ID)()(Data)(Cr)

Data 00: Screen On
01: Screen Off

Acknowledgment

(d)()(Set ID)()(OK/NG)(Data)(x)

* This feature may not be available for all models.

36. [Tile Mode] (Command: d d)

Sets a tile mode and values for the tile rows and columns.

Transmission

(d)(d)()(Set ID)()(Data)(Cr)

Data 00-FF: The first byte - tile column
The second byte - tile row

- * 00, 01, 10, and 11 mean that the tile mode is off.
- * The maximum value may differ depending on the model.
- * When the OSD rotation is set to 90° or 270°, the columns and rows work reversely.

Acknowledgment

(d)()(Set ID)()(OK/NG)(Data)(x)

* This feature may not be available for all models.

37. [Tile Mode] Check (Command: d z)

Checks the tile mode.

Transmission

(d)(z)()(Set ID)()(Data)(Cr)

Data FF: Check Tile Mode

Acknowledgment

(z)()(Set ID)()(OK/NG)(Data1)(Data2)(Data3)(x)

Data1 00: Tile Mode off
01: Tile Mode on

Data2 00-0F: Tile column
Data3 00-0F: Tile row

* This feature may not be available for all models.

38. [Tile ID] (Command: d i)

Sets the tile ID value of the product.

Transmission

(d)(i)()(Set ID)()(Data)(Cr)

Data 01-E1: Tile ID 1-225
FF: Checks the Tile ID

* The data value cannot exceed the value of row x column.

Acknowledgment

(i)()(Set ID)()(OK/NG)(Data)(x)

- * If you enter a value that exceeds the value of row x column for the Data parameter (except for 0xFF), Ack becomes NG.
- * This feature may not be available for all models.

39. [Natural Mode] (In Tile Mode) (Command: d j)

To display the image naturally, the part of the image that would normally be displayed in the gap between the monitors is omitted.

Transmission

```
(d)(j)( )(Set ID)( )(Data)(Cr)
```

```
Data 00: Off
      01: On
```

Acknowledgment

```
(j)( )(Set ID)( )(OK/NG)(Data)(x)
```

* This feature may not be available for all models.

40. Tile H Position (Command: d e)

Adjusts the H Position in Tile Mode. (This function is only available when Tile Mode is set to On and Natural Mode is set to Off.)

Transmission

```
(d)(e)( )(Set ID)( )(Data)(Cr)
```

```
Data 00 - 32: -50(Left) - 0(Right)
```

* Left/Right values vary depending on the tile H Size.

Acknowledgment

```
(e)( )(Set ID)( )(OK/NG)(Data)(x)
```

* This feature may not be available for all models.

41. Tile V Position (Command: d f)

Adjusts the V Position in Tile Mode. (This function is only available when Tile Mode is set to On and Natural Mode is set to Off.)

Transmission

```
(d)(f)( )(Set ID)( )(Data)(Cr)
```

```
Data 00 - 32: 0(Down) - 50(Top)
```

* Vertical values vary depending on the tile V Size.

Acknowledgment

```
(f)( )(Set ID)( )(OK/NG)(Data)(x)
```

* This feature may not be available for all models.

42. Tile H Size (Command: d g)

Adjusts the H Size in Tile Mode. (Before adjusting the Tile H Size, set the Tile H Position as 0 X 32. This function is only available when Tile Mode is set to On and Natural Mode is set to Off.)

Transmission

```
(d)(g)( )(Set ID)( )(Data)(Cr)
```

```
Data 00 - 32: 0 - 50
```

Acknowledgment

```
(g)( )(Set ID)( )(OK/NG)(Data)(x)
```

* This feature may not be available for all models.

43. Tile V Size (Command: d h)

Adjusts the V Size in Tile Mode. (Before adjusting the Tile V Size, set the Tile V Position as 0 X 00. This function is only available when Tile Mode is set to On and Natural Mode is set to Off.)

Transmission

```
(d)(h)( )(Set ID)( )(Data)(Cr)
```

```
Data 00 - 32: 0 - 50
```

Acknowledgment

```
(h)( )(Set ID)( )(OK/NG)(Data)(x)
```

* This feature may not be available for all models.

44. [DPM] (Command: f j)

Sets the DPM(Display Power Management) function.

Transmission

```
(f)(j)( )(Set ID)( )(Data)(Cr)
```

```
Data 00: [Off]
      01: 5 seconds
      02: 10 seconds
      03: 15 seconds
      04: 1 minute
      05: 3 minute
      06: 5 minute
      07: 10 minute
```

Acknowledgment

```
(j)( )(Set ID)( )(OK/NG)(Data)(x)
```

* This feature may not be available for all models.

45. [DPM Wake Up Control] (Command: s n, 0b)

Sets the DPM deactivation Control mode.

Transmission**(s)(n)()(Set ID)()(0)(b)()(Data)(Cr)**

Data 00: Sets the clock mode

01: Sets the clock + data mode

Acknowledgment**(n)()(Set ID)()(OK/NG)(0)(b)(Data)(x)**

* This feature may not be available for all models.

48. [Fail Over] Mode (Command: m i)

Sets an input mode for fail over.

Transmission**(m)(i)()(Set ID)()(Data)(Cr)**

Data 00: [Off]

01: [Auto]

02: [User Setting]

Acknowledgment**(i)()(Set ID)()(OK/NG)(Data)(x)**

* This feature may not be available for all models.

46. Remote Control/[Local Key Operation Lock] (Command: k m)

Adjusts the remote control/local key (front) lock.

Transmission**(k)(m)()(Set ID)()(Data)(Cr)**

Data 00: Off (Lock Off)

01: On (Lock On)

Acknowledgment**(m)()(Set ID)()(OK/NG)(Data)(x)**

* This feature may not be available for all models.

49. [Fail Over] Input Select (Command: m j)

Selects an input source for fail over. (This feature is only available when Fail Over is set to Custom.)

Transmission**(m)(j)()(Set ID)()(Data1)()(Data2)()(Data3)()(Data4)****... ()(DataN)(Cr)**

Data1-N (Input priority 1-N)

60: RGB

80: DVI-D

90: HDMI

C0: Display Port

91: HDMI2/SDI/OPS

98: OPS

Acknowledgment**(j)()(Set ID)()(OK/NG)(Data1)(Data2)(Data3)(Data4)****...(DataN) (x)**

* Some input signals may not be available for all models.

* The data number (N) may vary depending on the model. (The data number depends on the number of supported input signals.)

47. [Power On Delay] (Command: f h)

Sets the schedule delay for when the power turns on. (Unit: seconds)

Transmission**(f)(h)()(Set ID)()(Data)(Cr)**

Data 00-FA: Min 0- Max 250 (sec)

Acknowledgment**(h)()(Set ID)()(OK/NG)(Data)(x)**

* The maximum value may differ depending on the model.

* This feature may not be available for all models.

50. Remote Control Key Lock (Command: t p)

Configures the settings of the product's remote control key.

Transmission**(t)(p)()(Set ID)()(Data)(Cr)**

Data 00: Unlocks all keys

01: Locks all keys except Power key

02: Locks all keys

Acknowledgment**(p)()(Set ID)()(OK/NG)(Data)(x)**

* This feature may not be available for all models.

51. [Local Key Operation Lock] (Command: t o)

Configures the local key operation settings of the product.

Transmission

(t)(o)() (Set ID)() (Data)(Cr)

Data 00: Unlocks all keys
01: Locks all keys except Power key
02: Locks all keys

Acknowledgment

(o)() (Set ID)() (OK/NG)(Data)(x)

* This feature may not be available for all models.

52. Status Check (Command: s v)

Checks the current signal of the product.

Transmission

(s)(v)() (Set ID)() (Data)() (FF)(Cr)

Data 02: Check whether there is a signal
10: RGB Sensor OK/NG(Check Screen)

Acknowledgment

(v)() (Set ID)() (OK/NG)(Data)(Data1)(x)

Data 02 (when a signal is found)
Data1 00: No signal
01: Signal present

Data 10 (Check Screen)
Data1 00: Check Screen result NG
07: Check Screen result OK

* When Check Screen is set to Off or not supported, execution results are rendered "NG."

53. [Screen Fault Detection] (Command: t z)

Sets the Screen Fault Detection feature.

Transmission

(t)(z)() (Set ID)() (Data)(Cr)

Data 00: Off
01: On

Acknowledgment

(z)() (Set ID)() (OK/NG)(Data)(x)

* This feature may not be available for all models.

54. [PM Mode] (Command: s n, 0c)

Sets the PM mode.

Transmission

(s)(n)() (Set ID)() (0c)() (Data)(Cr)

Data 00: [Power Off]
01: [Sustain Aspect Ratio]
02: [Screen Off]
03: [Screen Off Always]
04: [Screen Off & Backlight On]

Acknowledgment

(n)() (Set ID)() (OK/NG)(0c)(Data)(x)

* This feature may not be available for all models.

55. [Screen Off Always] (Command: j p)

If you activate the Screen Off Always feature, the monitor enters Screen Off mode regardless of whether or not you have activated PM mode.

Transmission

(j)(p)() (Set ID)() (Data)(Cr)

Data 00: On (Screen on)
01: Off (Screen off)

* This feature may not be available for all models.

Acknowledgment

(n)() (Set ID)() (OK/NG)(0d)(Data)(x)

56. [Auto Config.] (Command: j u)

Automatically corrects the position and shaking of the picture. (Works only in RGB-PC input mode.)

Transmission

(j)(u)() (Set ID)() (Data)(Cr)

Data 01: Execute

Acknowledgment

(u)() (Set ID)() (OK/NG)(Data)(x)

57. [Digital Audio Input] (Command: s n, 04)

Sets Digital Audio Input.

Transmission`(s)(n)()(Set ID)()(04)()(Data)(Cr)`Data 00: Digital
01: Analog**Acknowledgment**`(n)()(Set ID)()(OK/NG)(04)(Data)(x)`**58. [Audio Out] (Command: s n, aa)**

Controls the Audio Out mode.

Transmission`(s)(n)()(Set ID)()(a)(a)()(Data)(Cr)`Data 00: [Off]
01: [Variable]
02: [Fixed]**Acknowledgment**`(n)()(Set ID)()(OK/NG)(a)(a)(Data)(x)`

* This feature may not be available for all models.

59. [OSD Rotation] (Command: t h)

Sets the OSD Rotation mode.

Transmission`(t)(h)()(Set ID)()(Data)(Cr)`Data 00: Off
01: 90 degrees
02: 270 degrees**Acknowledgment**`(h)()(Set ID)()(OK/NG)(Data)(x)`

* This feature may not be available for all models.

60. [Pivot Mode] (Command: t a)

Controls Pivot Mode.

Transmission`(t)(a)()(Set ID)()(Data)(Cr)`Data 00: Off
01: On**Acknowledgment**`(a)()(Set ID)()(OK/NG)(Data)(x)`

* This feature may not be available for all models.

61. [Brightness Scheduling] Mode (Command: s m)

Selects a Brightness Scheduling mode.

Transmission`(s)(m)()(Set ID)()(Data)(Cr)`Data 00: Off
01: On**Acknowledgment**`(m)()(Set ID)()(OK/NG)(Data)(x)`

* This feature does not work if the current time is not set.

* This feature may not be available for all models.

62. [Brightness Scheduling] (Command: s s)

Sets Brightness Scheduling.

Transmission**(s)(s)()(Set ID)()(Data1)()(Data2)()(Data3)(Cr)**

Data1

1. f1 to f6 (data reading)

F1: Reads the 1st [Brightness Scheduling]'s data

F2: Reads the 2nd [Brightness Scheduling]'s data

F3: Reads the 3rd [Brightness Scheduling]'s data

F4: Reads the 4th [Brightness Scheduling]'s data

F5: Reads the 5th [Brightness Scheduling]'s data

F6: Reads the 6th [Brightness Scheduling]'s data

2. FF: Reads all stored lists

3. e1 to e6 (Deletes one index), e0 (Deletes all indexes)

E0: Deletes all quick brightness controls

E1: Deletes the 1st [Brightness Scheduling]'s control

E2: Deletes the 2nd [Brightness Scheduling]'s control

E3: Deletes the 3rd [Brightness Scheduling]'s control

E4: Deletes the 4th [Brightness Scheduling]'s control

E5: Deletes the 5th [Brightness Scheduling]'s control

E6: Deletes the 6th [Brightness Scheduling]'s control

4. 00-17: 00 - 23 hours

Data2 00-3B: 00 - 59 minutes

Data3 00-64: Backlight 0 - 100

- * To read or delete a list of [Brightness Scheduling] you have set, [Data2][Data3] must be set to FF.
- * If you want to read a complete list of [Brightness Scheduling] you have set through FF, do not enter any values in [Data2][Data3].
- * If you want to read a complete list of [Brightness Scheduling] you have set through FF, NG is acknowledged if there is no stored list.

Example 1: ss 01 f1 ff ff - Reads the 1st index data from the [Brightness Scheduling].

Example 2: ss 01 ff - Reads all index data from the [Brightness Scheduling].

Example 3: ss 01 e1 ff ff - Deletes the 1st index data from the [Brightness Scheduling].

Example 4: ss 01 07 1E 46 - Adds a schedule whose time is 07:30 and whose backlight is 70.

Acknowledgment**(s)()(Set ID)()(OK/NG)(Data1)(Data2)(Data3)(x)**

- * This feature may not be available for all models.

63. [Contents Sync] (Command: t g)

Selects a Contents Sync settings.

Transmission**(f)(g)()(Set ID)()(Data)(Cr)**

Data 00: Off

01: On

Acknowledgment**(g)()(Set ID)()(OK/NG)(Data)(x)**

- * This feature may not be available for all models.

64. [Time Sync] (Command: s n, 16)

Sets the time to synchronize.

Transmission**(s)(n)()(Set ID)()(1)(6)()(Data)(Cr)**

Data 00: Off

01: Sets to 00:00

02: Sets to 1:00 AM

...

18: Sets to 11:00 PM

Acknowledgment**(n)()(Set ID)()(OK/NG)()(1)(6)()(Data)(x)**

- * This feature does not work if there is no Master monitor.
- * The settings screen is displayed only on the Master monitor.
- * This feature does not work if the current time is not set.
- * This feature may not be available for all models.

65. Timer Power On Scheduling (Command: f b)

Sets the Timer Power On Scheduling function.

Transmission**(f)(b)()(Set ID)()(Data)(Cr)**Data 00: Off
01: On**Acknowledgment****(b)()(Set ID)()(OK/NG)(Data)(x)****66. Timer Power Off Scheduling (Command: f c)**

Sets the Timer Power Off Scheduling function.

Transmission**(f)(c)()(Set ID)()(Data)(Cr)**Data 00: Off
01: On**Acknowledgment****(c)()(Set ID)()(OK/NG)(Data)(x)****67. [Timer Power On] (Repeat Mode / Time) (Command: f d)**

Sets the Timer Power On (Repeat Mode / Time) function.

Transmission**(f)(d)()(Set ID)()(Data1)()(Data2)()(Data3)(Cr)**

Data1

1. f1h to f7h (data reading)

F1: Reads the 1st Timer Power On's data
F2: Reads the 2nd Timer Power On's data
F3: Reads the 3rd Timer Power On's data
F4: Reads the 4th Timer Power On's data
F5: Reads the 5th Timer Power On's data
F6: Reads the 6th Timer Power On's data
F7: Reads the 7th Timer Power On's data

2. e1h to e7h (Deletes one index), e0h (Deletes all indexes)

E0: Delete all Timer Power On's
E1: Delete the 1st Timer Power On
E2: Delete the 2nd Timer Power On
E3: Delete the 3rd Timer Power On
E4: Delete the 4th Timer Power On
E5: Delete the 5th Timer Power On
E6: Delete the 6th Timer Power On
E7: Delete the 7th Timer Power On

3. 01h to 0ch (Timer Power On days setting)

01: Repeat Once
02: Repeat Daily
03: Repeat from Monday to Friday
04: Repeat from Monday to Saturday
05: Repeat from Saturday to Sunday
06: Repeat on Sunday
07: Repeat on Monday
08: Repeat on Tuesday
09: Repeat on Wednesday
0A: Repeat on Thursday
0B: Repeat on Friday
0C: Repeat on Saturday
Data2 00-17: 00 - 23 hours
Data3 00-3B: 00 - 59 minutes

* To read or delete a Timer Power On you have set, [Data2][Data3] must be set to FFh.

Example 1: fd 01 f1 ff ff - Reads the 1st index data in Timer Power On.

Example 2: fd 01 e1 ff ff - Reads the 1st index data in Timer Power On.

Example 3: fd 01 04 02 03 - Sets the Timer Power On as Monday - Saturday 02:03.

* This feature only works when Clock 1 (year/month/day) and Clock 2 (hour/minute/second) have been set.

Acknowledgment**(d)()(Set ID)()(OK/NG)(Data1)(Data2)(Data3)(x)**

68. [Timer Power Off] (Repeat Mode / Time) (Command: f e)

Sets the Timer Power Off (Repeat Mode / Time) function.

Transmission

(f)(e)()(Set ID)()(Data1)()(Data2)()(Data3)(Cr)

Data1

1. f1h to f7h (data reading)

F1: Reads the 1st Timer Power Off's data
 F2: Reads the 2nd Timer Power Off's data
 F3: Reads the 3rd Timer Power Off's data
 F4: Reads the 4th Timer Power Off's data
 F5: Reads the 5th Timer Power Off's data
 F6: Reads the 6th Timer Power Off's data
 F7: Reads the 7th Timer Power Off's data

2. e1h to e7h (Deletes one index), e0h (Deletes all indexes)

E0: Delete all Timer Power Off's
 E1: Delete the 1st Timer Power Off
 E2: Delete the 2nd Timer Power Off
 E3: Delete the 3rd Timer Power Off
 E4: Delete the 4th Timer Power Off
 E5: Delete the 5th Timer Power Off
 E6: Delete the 6th Timer Power Off
 E7: Delete the 7th Timer Power Off

3. 01h to 0ch (Timer Power Off days setting)

01: Repeat Once
 02: Repeat Daily
 03: Repeat from Monday to Friday
 04: Repeat from Monday to Saturday
 05: Repeat from Saturday to Sunday
 06: Repeat on Sunday
 07: Repeat on Monday
 08: Repeat on Tuesday
 09: Repeat on Wednesday
 0A: Repeat on Thursday
 0B: Repeat on Friday
 0C: Repeat on Saturday
 Data2 00-17:00 - 23 hours
 Data3 00-3B:00 - 59 minutes

* To read or delete a Timer Power Off you have set, [Data2][Data3] must be set to FFh.

Example 1: fe 01 f1 ff ff - Reads the 1st index data in Timer Power Off.

Example 2: fe 01 e1 ff ff - Reads the 1st index data in Timer Power Off.

Example 3: fe 01 04 02 03 - Sets the Timer Power Off as Monday - Saturday 02:03.

* This feature only works when Clock 1 (year/month/day) and Clock 2 (hour/minute/second) have been set.

Acknowledgment

(e)()(Set ID)()(OK/NG)(Data1)(Data2)(Data3)(x)

69. [Holiday Setting] Mode (Command: s n, 1a)

Sets the Holiday Schedule mode to On or Off.

Transmission

(s)(n)()(Set ID)()(1)(a)()(Data)(Cr)

Data 00: Holiday Schedule Off
 01: Holiday Schedule On

Acknowledgment

(n)()(Set ID)()(OK/NG)()(1)(a)()(Data)(x)

* This feature does not work if the current time is not set.

* This feature may not be available for all models.

70. [Holiday Setting] (Command: s n, 1b)

Sets holiday schedules.

Transmission

(s)(n)()(Set ID)()(1)(a)()(Data1)()(Data2)()(Data3)()(Data4)(Cr)

Data1

1. f1 to f7 (data reading)

f1: Reads the 1st Holiday Schedule's data
 f2: Reads the 2nd Holiday Schedule's data
 f3: Reads the 3rd Holiday Schedule's data
 f4: Reads the 4th Holiday Schedule's data
 f5: Reads the 5th Holiday Schedule's data
 f6: Reads the 6th Holiday Schedule's data
 f7: Reads the 7th Holiday Schedule's data

2. FF: Reads all stored lists

3. e1 to e7 (Deletes one index), e0 (Deletes all indexes)

e0: Deletes all holiday schedules
 e1: Deletes the 1st holiday schedule
 e2: Deletes the 2nd holiday schedule
 e3: Deletes the 3rd holiday schedule
 e4: Deletes the 4th holiday schedule
 e5: Deletes the 5th holiday schedule
 e6: Deletes the 6th holiday schedule
 e7: Deletes the 7th holiday schedule

4. 01 - 0c: January - December (Start Month)

Data2 01-1F: 01 - 31 (Start Day)

Data3 01 - 0c: January - December (End Month)

Data4 01-1F: 01 - 31 (End Day)

- * To read or delete a Holiday Schedule you have set, [Data2][Data3][Data4] must be set to FF.
- * To read all Holiday Schedules you have set, [Data1][Data2][Data3][Data4] must be set to FF.

Example 1: sn 01 1b f1 ff ff ff - Reads the 1st index data in Holiday Schedule.

Example 2: sn 01 1b ff ff ff ff - Reads all index data in Holiday Schedule.

Example 3: sn 01 1b e1 ff ff ff - Deletes the 1st index data in Holiday Schedule.

Example 4: sn 01 1b 01 07 0c 18 - Sets and adds the holiday schedule from January 7 to December 24.

- * Schedules that have been set in advance are not added.
- * This feature does not work if the current time is not set.
- * This feature may not be available for all models.

Acknowledgment

(s)()(Set ID)()(OK/NG)(Data1)(Data2)(Data3)(x)

71. [Power On Status] (Command: t r)

Sets the Power On status of the monitor.

Transmission

(t)(r)()(Set ID)()(Data)(Cr)

Data 00: LST (Maintains the previous power status)
01: STD (Keeps the power off)
02: PWR (Keeps the power on)

Acknowledgment

(r)()(Set ID)()(OK/NG)(Data)(x)

72. [Wake On LAN] (Command: f w)

Selects a Wake On LAN option.

Transmission

(f)(w)()(Set ID)()(Data)(Cr)

Data 00: Off
01: On

Acknowledgment

(w)()(Set ID)()(OK/NG)(Data)(x)

73. [ISM Method] (Command: j p)

Sets the ISM Method function.

Transmission

(j)(p)()(Set ID)()(Data)(Cr)

Data 01: [Inversion]
02: [Orbiter]
04: [Remove (white pattern)]
08: [Standard]
20: [Remove (colored pattern)]
80: [Washing Bar]
90: [User Image]

- * If Timer is set to Immediately, the jp command operates.

Acknowledgment

(p)()(Set ID)()(OK/NG)(Data)(x)

74. [Booting Logo Image] (Command: s n, a3)

Sets the Booting Logo Image mode.

Transmission

(s)(n)()(Set ID)()(a)(3)()(Data)(Cr)

Data 00: Off
01: On

Acknowledgment

(n)()(Set ID)()(OK/NG)(a)(3)(Data)(x)

- * This feature may not be available for all models.

75. [No Signal Image] (Command: s n, a9)

Turns on/off No Signal Image.

Transmission

(s)(n)()(Set ID)()(a)(9)()(Data)(Cr)

Data 00: Off
01: On

Acknowledgment

(n)()(Set ID)()(OK/NG)(a)(9)(Data)(x)

- * This feature may not be available for all models.

76. H Position (Command: f q)

Adjusts the horizontal position of the screen. (This feature only works when Tile Mode is set to Off)

- * The operational range varies depending on the RGB input resolution. (Works only in RGB-PC input mode.)

Transmission

(f)(q)()(Set ID)()(Data)(Cr)

Data 00-64: Minimum -50 (Left) - Maximum 50 (Right)

Acknowledgment

(q)()(Set ID)()(OK/NG)(Data)(x)

77. V Position (Command: f r)

Adjusts the vertical position of the screen. (This feature only works when Tile Mode is set to Off)

- * The operational range varies depending on the RGB input resolution. (Works only in RGB-PC input mode.)

Transmission

(f)(r)()(Set ID)()(Data)(Cr)

Data 00 - 64: Minimum -50 (Down) - Maximum 50 (Up)

Acknowledgment

(r)()(Set ID)()(OK/NG)(Data)(x)

78. H Size (Command: f s)

Adjusts the horizontal size of the screen. (This feature only works when Tile Mode is set to Off)

- * The operational range varies depending on the RGB input resolution. (Works only in RGB-PC input mode.)

Transmission

(f)(s)()(Set ID)()(Data)(Cr)

Data 00 - 64: Minimum -50 (Small) - Maximum 50 (Large)

Acknowledgment

(s)()(Set ID)()(OK/NG)(Data)(x)

79. [Home Dashboard Lock] (Command: s n, 9d)

Sets Home Dashboard Lock.

Transmission

(s)(n)()(Set ID)()(9)(d)()(Data)(Cr)

Data 00: Off

01: On

Acknowledgment

(n)()(Set ID)()(OK/NG)(9)(d)(Data)(x)

- * This feature may not be available for all models.

80. [USB Lock] (Command: s n, 9e)

Sets USB Lock.

Transmission

(s)(n)()(Set ID)()(9)(e)()(Data)(Cr)

Data 00: Off

01: On

Acknowledgment

(n)()(Set ID)()(OK/NG)(9)(e)(Data)(x)

- * This feature may not be available for all models.

81. [OSD Lock] (Command: k l)

Selects an OSD Display option.

Transmission

(k)(l)()(Set ID)()(Data)(Cr)

Data 00: Off (OSD Lock: Off)

01: On (OSD Lock: On)

Acknowledgment

(l)()(Set ID)()(OK/NG)(Data)(x)

82. [Change Password] (Command: s n, a7)

Changes password.

Transmission

```
(s)(n)( )(Set ID)( )(a)(7)( )(Data1)(Data2)(Data3)
(Data4)( )(Data5)(Data6)(Data7)(Data8)(Cr)
```

Data 1-4: 0-9 (Previously set password)

Data 5-8: 0-9 (New password)

Acknowledgment

```
(n)( )(Set ID)( )(OK/NG)(a)(7)( )(Data1)(Data2)
(Data3)(Data4)( )(Data5)(Data6)(Data7)(Data8)(x)
```

* This feature may not be available for all models.

85. Fail Over USB Input (Command: s n, 0a)

Selects a USB status for fail over.

Transmission

```
(s)(n)( )(Set ID)( )(0a)( )(Data)(Cr)
```

Data 00: [Off]

01: [Picture]

02: [Photos]

Acknowledgment

```
(n)( )(Set ID)( )(OK/NG)(0a)(Data)(x)
```

86. Fan Failure Check (Command: d w)

Check the fan malfunction.

Transmission

```
(d)(w)( )(Set ID)( )(Data)(Cr)
```

Data FF: Read status

Acknowledgment

```
(w)( )(Set ID)( )(OK/NG)(Data)(x)
```

Data 00: Fan failure

01: Fan normal

* This feature may not be available for all models.

83. [Apply to all inputs] (Command: s n, 52)

Applies the picture mode and low value of the current input to the same video value of all inputs.

Transmission

```
(s)(n)( )(Set ID)( )(5)(2)( )(Data)(Cr)
```

Data 01: Apply

Acknowledgment

```
(n)( )(Set ID)( )(OK/NG)(5)(2)(Data)(x)
```

* This feature may not be available for all models.

84. OSD Position (Command: s n, ac)

Changes the screen position when the OSD Rotation function is set to On.

Transmission

```
(s)(n)( )(Set ID)( )(a)(c)( )(Data)(Cr)
```

Data 00: Top

01: Medium

02: Bottom

Acknowledgment

```
(n)( )(Set ID)( )(OK/NG)(a)(c)(Data)(x)
```

* This feature may not be available for all models.

87. [Network Setting] (Command: s n, 80 or 81 or 82)

Configures network and DNS settings.

Transmission

(s)(n)()(Set ID)()(Data1)()(Data2)()

(Data3)()(Data4)()(Data5)(Cr)

Data1 80: Configures/views the temporary IP mode (Auto/Manual), subnet mask, and gateway.

81: Configures/views the temporary DNS address.

82: Saves temporary settings and views information about the current network.

* If Data1 is 80,

Data2 00: Auto

01: Manual

FF: Views the temporary IP mode (Auto/Manual), subnet mask, and gateway.

** If Data2 is 01 (Manual),

Data3: Manual IP address

Data4: Subnet mask address

Data5: Gateway address

* If Data1 is 81,

Data2 DNS address

FF: Displays the temporary DNS address.

* If Data1 is 82,

Data2 80: Applies the temporary IP mode (Auto/Manual), subnet mask, and gateway.

81: Applies the temporary DNS address

FF: Information on the current network (IP, subnet gateway and DNS)

*** An example of settings,

1. Auto: sn 01 80 00

2. Manual: sn 01 80 01 010177223241 255255254000
010177222001(IP:10.177.223.241, subnet: 255.255.254.0,
gateway: 10.177.222.1)

3. Network read: sn 01 80 ff

4. DNS setting: sn 01 81 156147035018 (DNS: 156.147.35.18)

5. Applying the settings: sn 01 82 80 (applies the saved IP mode (auto/manual), subnet mask, and gateway), sn 01 82 81 (applies the saved DNS)

* Each IP address contains 12 decimal digits.

Acknowledgment

(n)()(Set ID)()(OK/NG)(Data1)(Data)(x)

* This feature is available only for wired networks.

* This feature may not be available for all models.

88. [Natural Size] (Command: s n, a5)

Sets the Natural Size feature.

Transmission

(s)(n)()(Set ID)()(a)(5)()(Data)(Cr)

Data 00 - 64: Natural Size 0 - 100

Acknowledgment

(n)()(Set ID)()(OK/NG)(a)(5)(Data)(x)

* This feature may not be available for all models.

