



Wireless Headset EHS Guide



Designer and Manufacturer of
**Professional Headsets for Contact Centres
& Unified Communications**

Wireless Headset EHS User Guide

Introduction

Electronic Hook Switch(EHS) provides a solution that enables remote operation of answer/end functions for wireless headsets with various phones, thus eliminating the need for a mechanical handset lifter.

Mobility

With EHS solution you can roam within your premises and still do business on the spot. Wireless headsets with EHS functionality boost productivity as they provide the user with the ability to answer and end a call, while away from their desk.

EHS support the following phone system manufacturers:

Wireless Headset EHS Compatibility Table

2022

Phone Model	EHS Adapter	JPL Part No
AASTRA / MITEL 5370, 5370ip, 5380, 5380ip, 6739i, 6771, 6773, 6773ip, 6775, 6775ip, 7434ip, 7444ip *6735i, *6737i, *6753i, *6755i, *6757i,	DS-DHSG Cable *Needs Aastra(Mitel) DHSG Kit	EHS-3
AASTRA / MITEL 6920, 6940	USB A-type	EHS-20
ALCATEL-LUCENT 4028 EE, 4038 EE, 4068 EE, 80XX	MSH Adapter	EHS-7
ALCATEL-LUCENT 8028s, 8058s, 8068s, 8078s	SATA Type Connector Adapter Cord	EHS-18
ALCATEL-LUCENT 8811	USB A-type	EHS-26
Allworx IP 9112, 9204, 9212, 9224, Verge 9312/9308/9304/9318Ex	Adapter	EHS-21
AVAYA 1408, 1416, 1608, 1616, 2410, 5410, 6224D+M, 6416D+M, 9404, 9408, 9504, 9508, 9608, 9610, 9611, 9620, 9621, 9630, 9640, 9641, 9650, 9670, J179, J100	AEI-II(Avaya) Adapter Kit	EHS-4
AVAYA 2420, 4610, 4620, 4621, 4622, 4625, 4630, 5420, 5610, 5620, 5621, 5625, 4610SW, 4620SW, 4621SW, 4622SW, 4625SW, 4630SW	Avaya compatible EHS Cable	EHS-15
AVAYA 1120E, 1140E, 1150E, 1165E	Avaya compatible EHS Cable	EHS-25
CISCO 6945, 7821, 7841, 7861, 7942G , 7945G, 7962G, 7965G, 7975G, 8811, 8841, 8845, 8851, 8861, 8865	HHC Adapter	EHS-2
CISCO (with USB Port) 8851, 8961, 9951, 9971	USB A-type EHS Adapter	EHS-12
ERICSSON-LG LIP-9010, LIP-9020, LIP-9050, iPECS 1030i	LG EHS Adapter Needs Ericsson-LG EHS Kit	EHS-11
ERICSSON-LG LIP-9071	USB A-type EHS Adapter	EHS-22
ERICSSON-LG LIP-9010, LIP-9020, LIP-9050, iPECS 1030i	LG EHS Adapter with JTAG	EHS-19
GRANDSTREAM GXP2124, GXP2130, GXP2140, GXP2160, GXP2200, GXP3240, GXV3275	Grandstream Adapter Kit	EHS-13
HTEK UC804, / 804T / 804G / 806 / 806T / 806G / 840 / 842 / 860 / 862 / 913 / 923 / 924 / 926	EHS Adapter	EHS-17

Wireless Headset EHS Compatibility Table

2022

Phone Model	EHS Adapter	JPL Part No
<p>NEC DT330 Series, DT430 Series, DT730 Series, DT830 Series, DT830G Series</p>	EHS Adapter	EHS-27
<p>PANASONIC DT543, DT546, NT553, NT556, HDV230,</p>	Panasonic compatible EHS Cable	EHS-1
<p>PANASONIC NT543</p>	Panasonic compatible EHS Cable	EHS-14
<p>POLYCOM IP320, IP321, IP330, IP331, IP335, IP435, IP450, IP550, IP560, IP650, IP670, VVX300 / 310 / 400 / 410 / 500 / 600 / 1500</p>	Polycom compatible EHS Cable	EHS-5
<p>SHORETEL IP212K, IP230, IP230G, IP265, IP560, IP560G, IP565, IP565G</p>	Adapter Kit	EHS-8
<p>SIEMENS/UNIFY OpenStage 30/40/60/80, OptiPoint Basic/Std/Adv/Eco 410/420/500/600</p>	DS-DHSG Cable	EHS-3
<p>SNOM *300, *320, *360, *370, *820, *821, *870</p>	DS-Gender *Needs SNOM EHS Adapter	EHS-6
<p>SNOM 720, 760</p>	USB A-type EHS Adapter	EHS-23
<p>SNOM 300, 320, 360, 370, 820, 821, 870</p>	EHS Adapter	EHS-24
<p>TOSHIBA DP5022-SD, DP5022-SDM, DP5032-SD, DP5122-SD, DP5130-FSDL, DP5130-SDL, DP5132-SD, IP5022-SD, IP5122-SD, IP5122-SDC, IP5131-SDL, IP5132-SD, IPT2008-SDL, IPT2010-SD, IPT2020-SD</p>	Adapter Kit	EHS-8
<p>YEALINK *T27G, *T27P, *T29G, *T40G, *T40P, *T41S, *T41P, *T42G, *T42S, *T46G, *T46S, * T48S</p>	DS-Gender *Needs Yealink EHS Adapter	EHS-6
<p>YEALINK T52S</p>	USB A-type	EHS-28
<p>SMART PHONE Galaxy & iPhone Series 4-6+</p>	3.5 phi Connector EHS Adapter	EHS-9

Aastra/Mitel EHS setup guide

Aastra/Mitel	Phones
	5370/5370ip 5380/5380ip6739i 6771/6773/6773ip 6775/6775ip 7434ip/7444ip



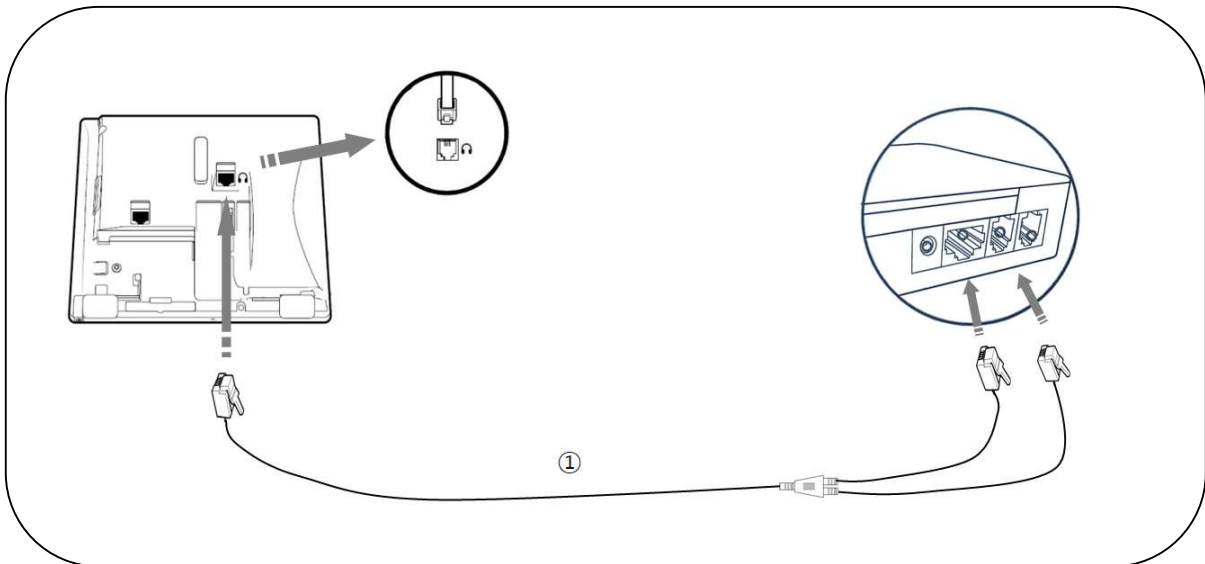

EHS-3

Connection Diagram

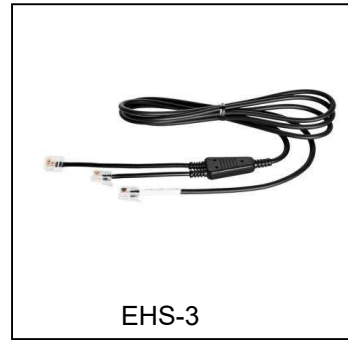

① EHS Cable(EHS-3) : RJ-45(8P8C) to RJ-45(8P8C) and RJ-9(4P4C)



Connection Diagram

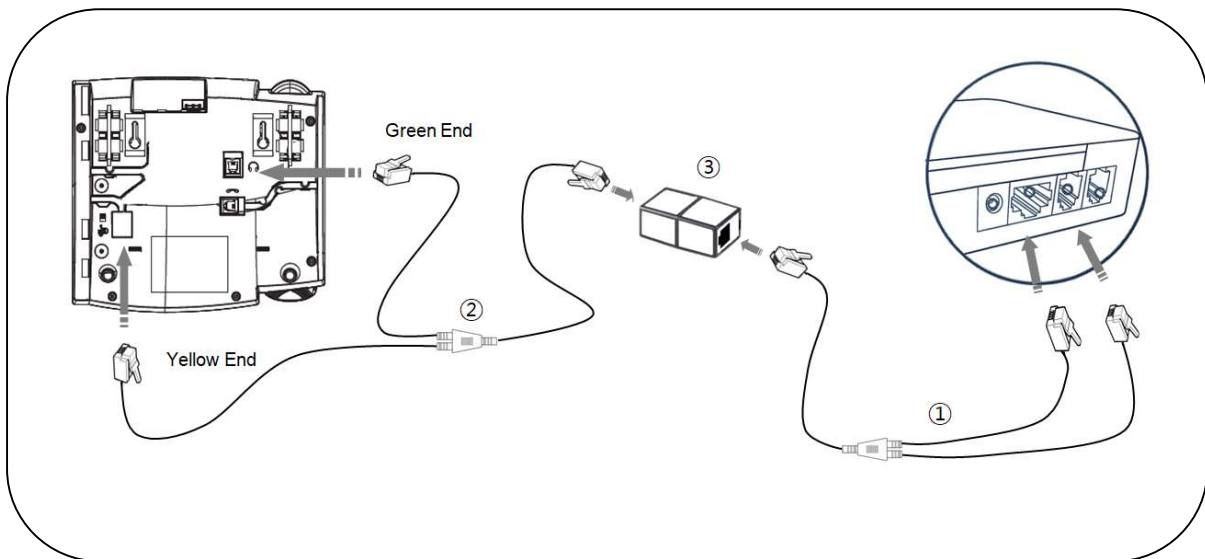

● **Note : Aastra(Mitel) DHSG cable kit is available from your Aastra(Mitel) reseller**

- ① EHS cable(EHS-3) : RJ-45(8P8C) to RJ-45(8P8C) and RJ-9(4P4C)
- ② Aastra(Mitel) DHSG cable : available from your reseller
- ③ RJ-45 Coupler : available from your reseller

Mitel EHS setup guide



Connection Diagram

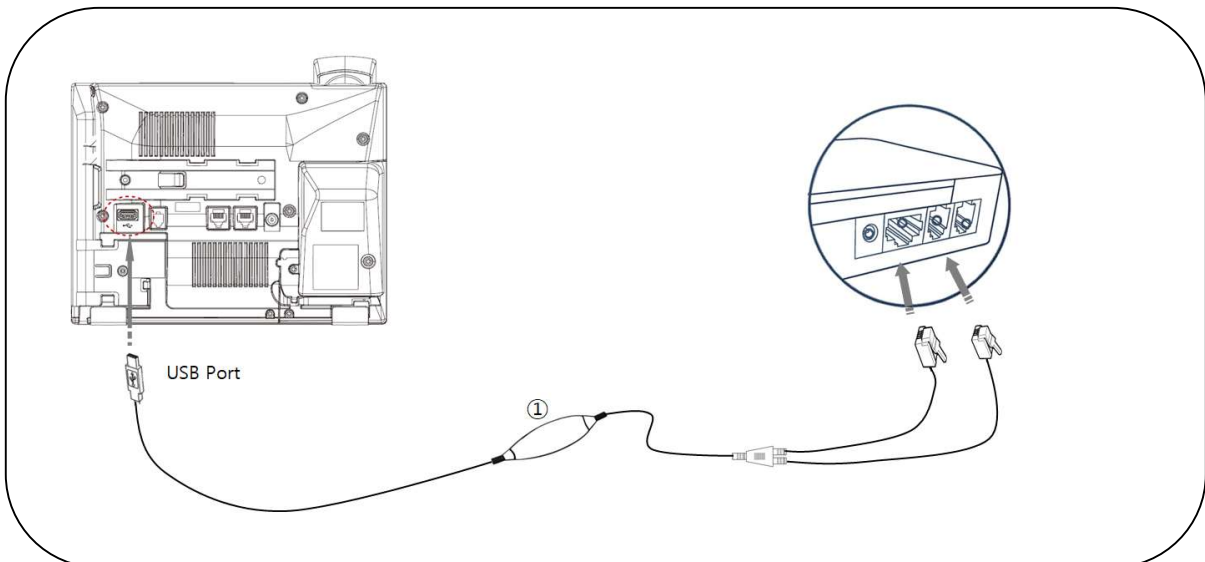

① EHS Adapter(EHS-20) : USB A-type to RJ-45 and RJ-9

Position of Telephone compatibility Switch : Set to '1'

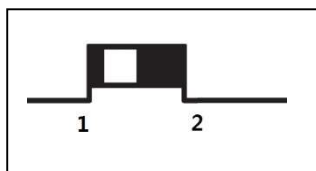

Alcatel EHS Setup guide



Connection Diagram

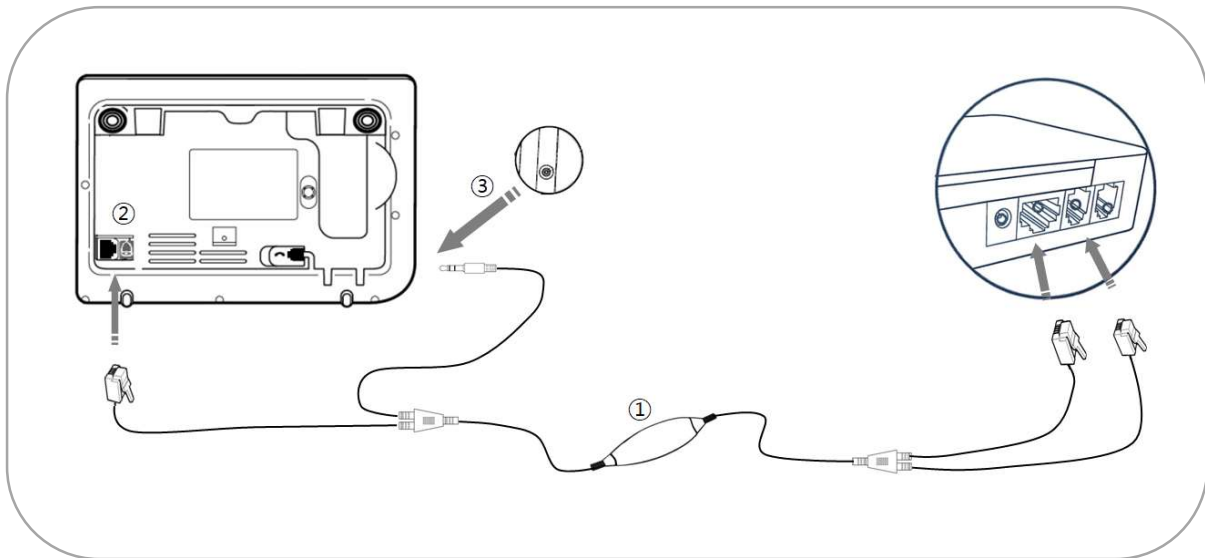

- ① EHS Adapter(EHS-7) : RJ-12(6P6C) and 3.5Ø plug to RJ-45(8P8C) and RJ-9(4P4C)
- ② External ring jack
- ③ Headset Port : 3.5Ø plug 3-poles

Connection Diagram

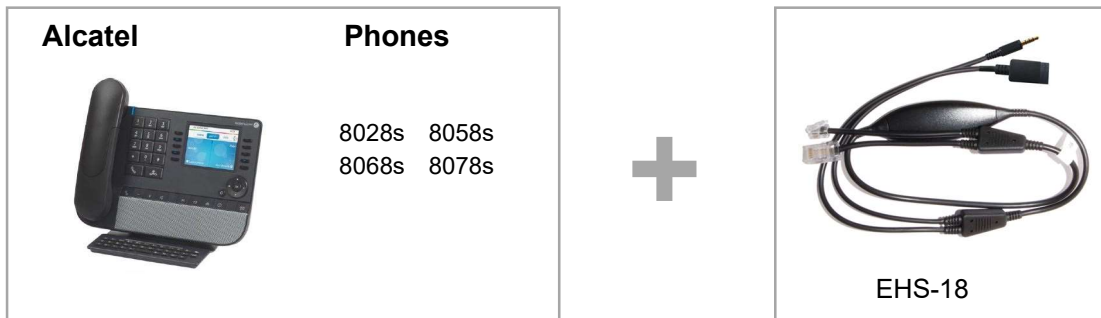

Connection Diagram

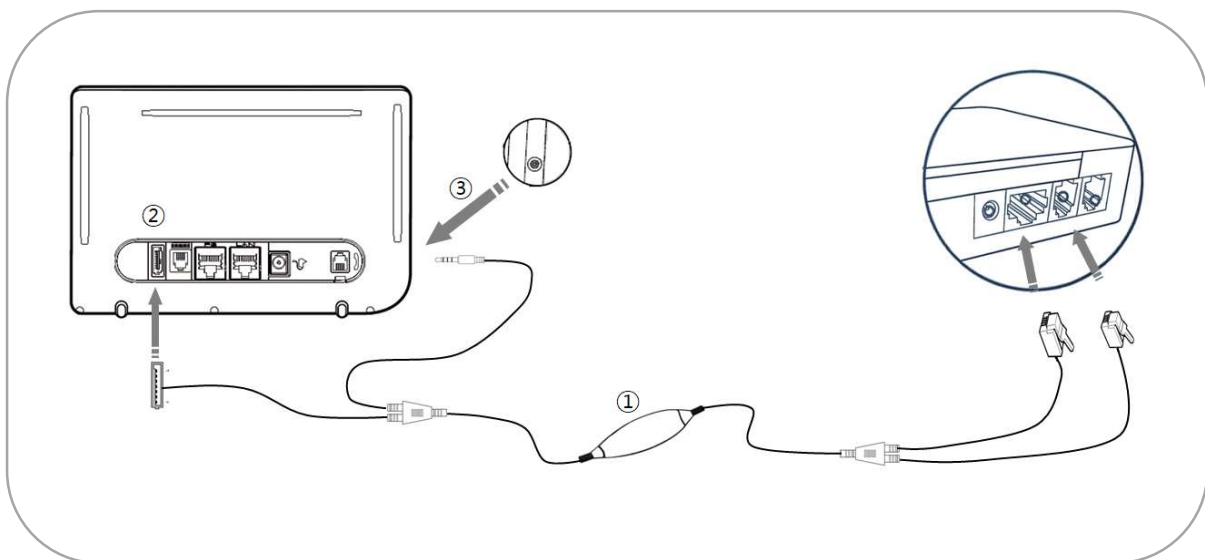

- ① EHS Adapter(EHS-18) : SATA connector and 3.5Ø plug to RJ-45(8P8C) and RJ-9(4P4C)
- ② External ring connector : SATA type
- ③ Headset Port : 3.5Ø plug 4-poles

Position of Telephone compatibility Switch : Set to '1'

Compatibility switch is located on left side of the base unit.

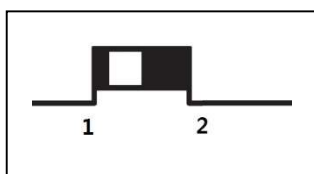

Connection Diagram



Connection Diagram

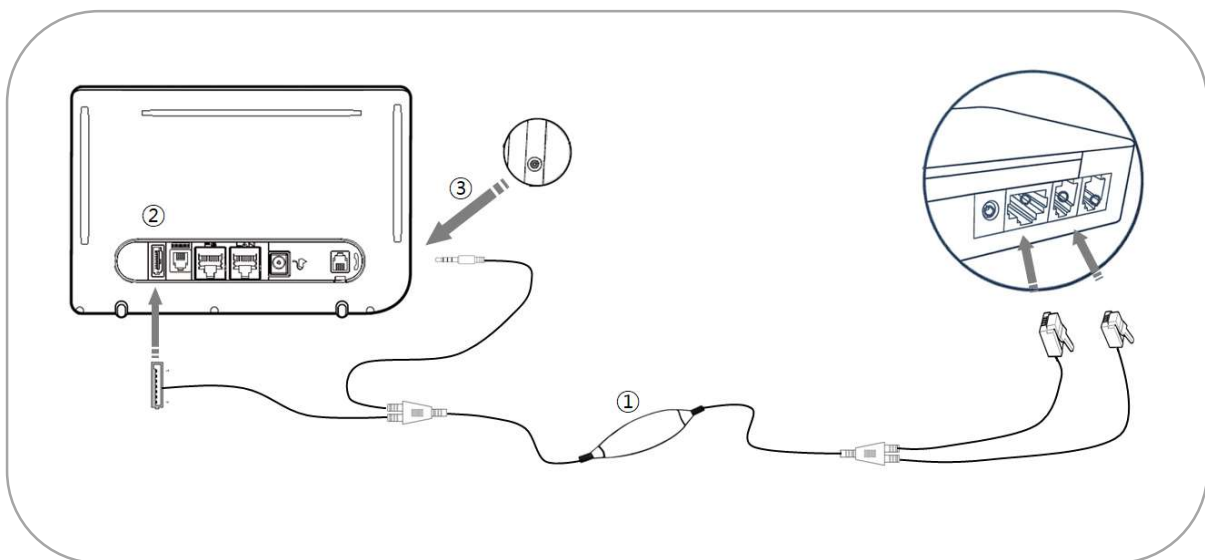

- ① EHS Adapter(EHS-26) : SATA connector and 3.5Ø plug to RJ-45(8P8C) and RJ-9(4P4C)
- ② External ring connector : SATA type
- ③ Headset Port : 3.5Ø plug 4-poles

Position of Telephone compatibility Switch : Set to '1'

Compatibility switch is located on left side of the base unit.

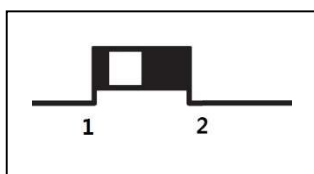

Allworx EHS Setup guide

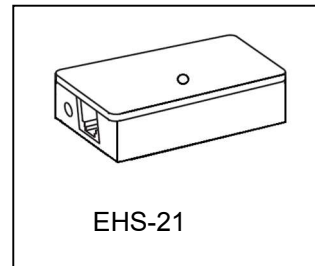

Connection Diagram

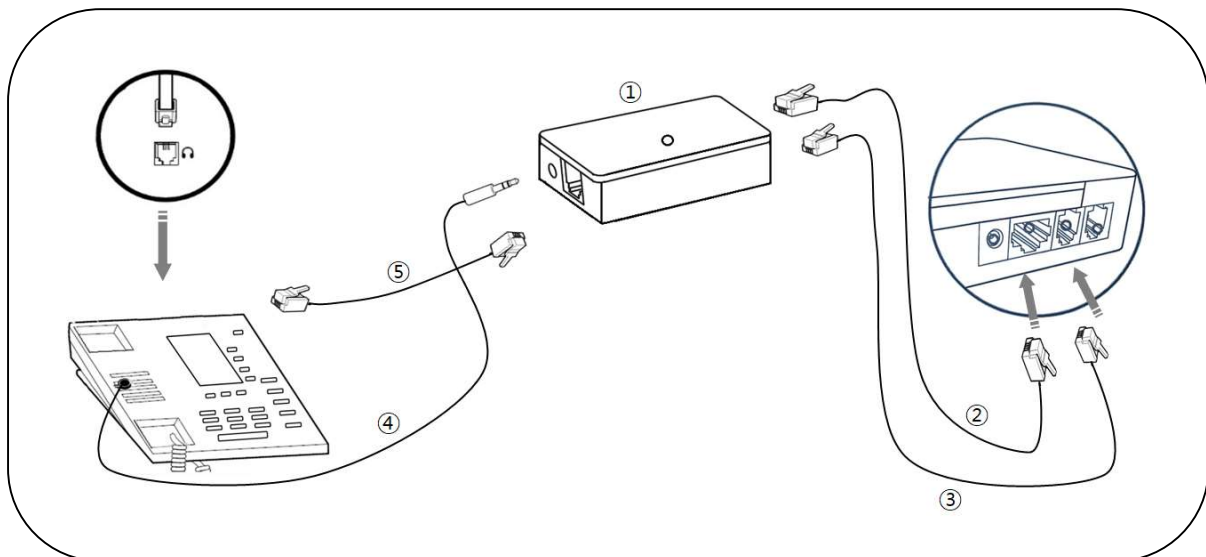

- ① EHS Adapter(EHS-21)
- ② Power cable (RJ-45 to RJ-45) : Cable length : 600mm
- ③ Telephone cord (RJ-9 to RJ-9) : Cable length : 600mm
- ④ External Microphone : For ring detection
- ⑤ Telephone cord (RJ-9 to RJ-9) : Cable length : 300mm

Position of Telephone compatibility Switch : Set to '1'

Compatibility switch is located on left side of the base unit.

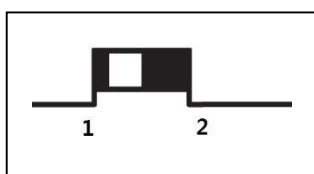

Avaya EHS Setup guide

Avaya	Phones		
	1408	1416	1608
	1616	2410	5410
	6224D+M/	6416D+M	
	9404	9408	9504
	9508	9608	9610
	9611	9620	9621
	9630	9640	9641
	9650	9670	J179

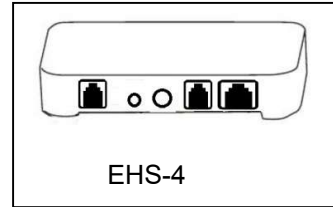

Connection Diagram

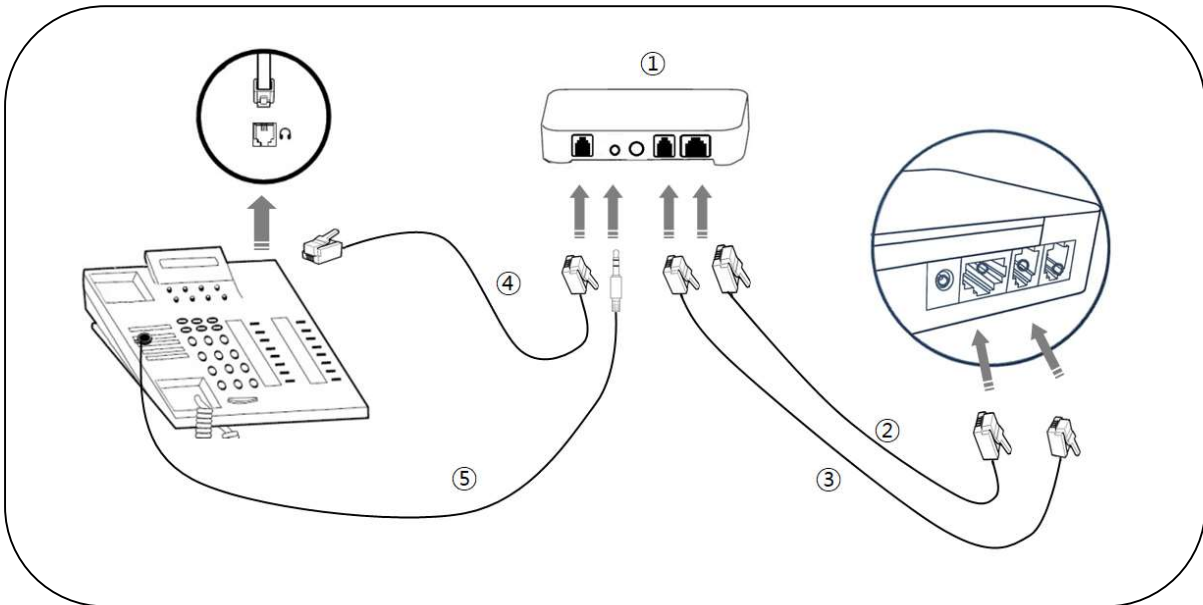

- ① : EHS Adapter (EHS-4)
- ② : Power cable (RJ-45 to RJ-12)
- ③ : Telephone cord (RJ-9 to RJ-9) Cable length : 600mm
- ④ : Telephone cord (RJ-9 to RJ-9) Cable length : 300mm
- ⑤ : External Microphone for ring detection

Position of Telephone compatibility Switch : Set to '1'

Compatibility switch is located on left side of the base unit.

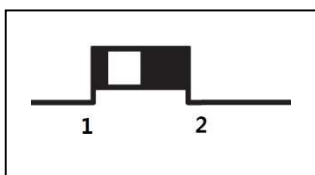

Avaya EHS Setup guide

Avaya	Phones
	2420
	4610/4610SW
	4620/4620SW
	4621/4621SW
	4622/4622SW
	4625/4625SW
	4630/4630SW
	5420/5610/5620/5621/5625



Connection Diagram

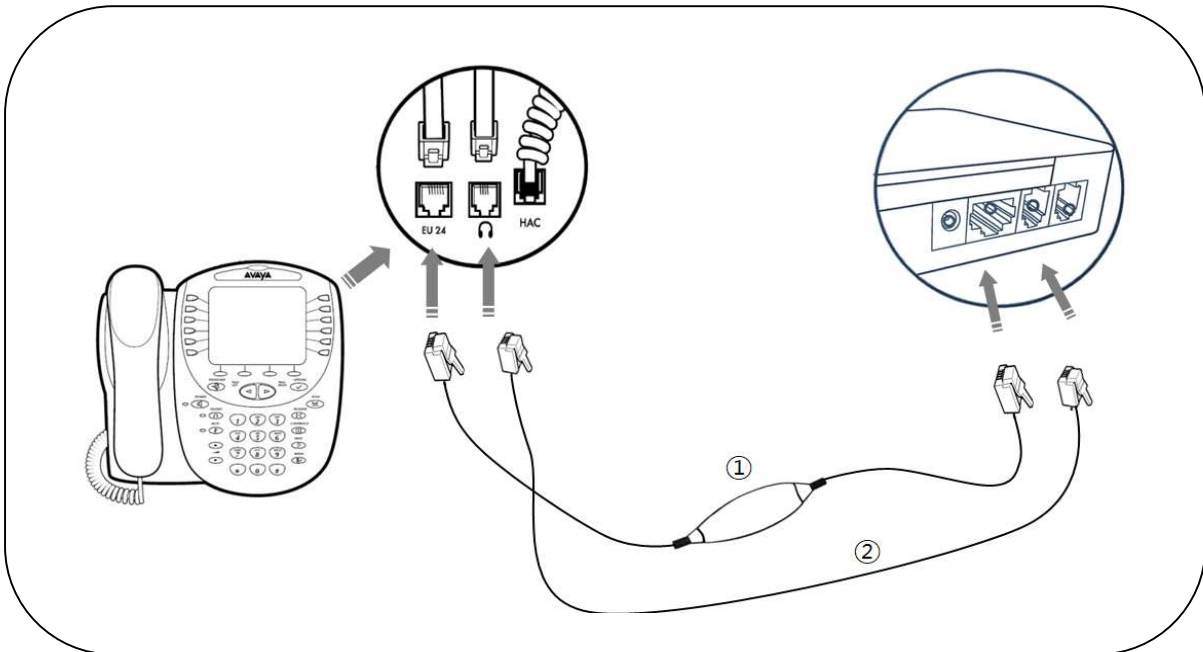

- ① EHS Adapter(EHS-15) : RJ-45 to RJ-12
- ② Telephone cord : RJ-9 to RJ-9 Cable length : 600mm

Position of Telephone compatibility Switch : Set to '1'
Compatibility switch is located on left side of the base unit.

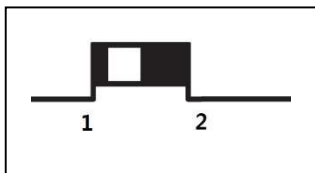

Avaya EHS Setup guide



Connection Diagram

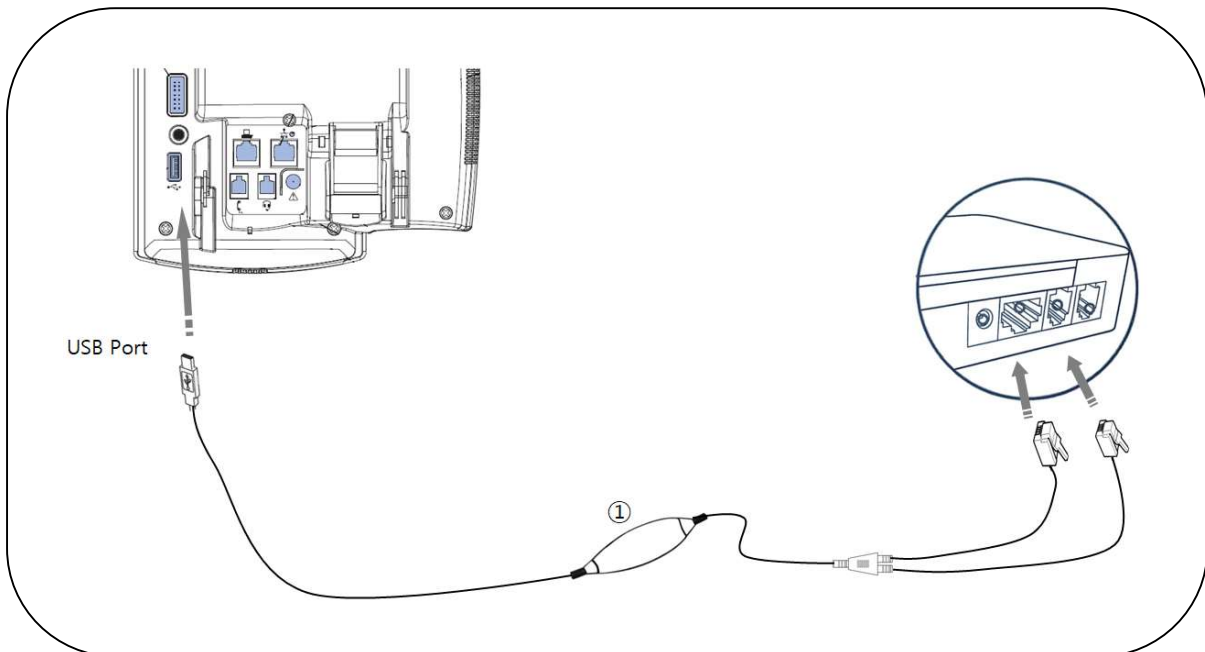

① EHS Adapter(EHS-25) : USB A-type male to RJ-45 and RJ-9

Position of Telephone compatibility Switch : Set to '1'

Compatibility switch is located on left side of the base unit.

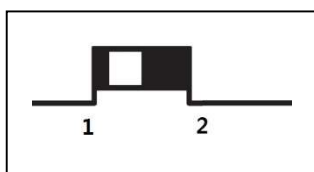

Cisco EHS Setup guide

Cisco	Phones
	6945
	7942G 7945G
	7962G 7965G
	7975G
	7821/7841/7861
	8811/8841/8845
	8851/8861/8865



Connection Diagram

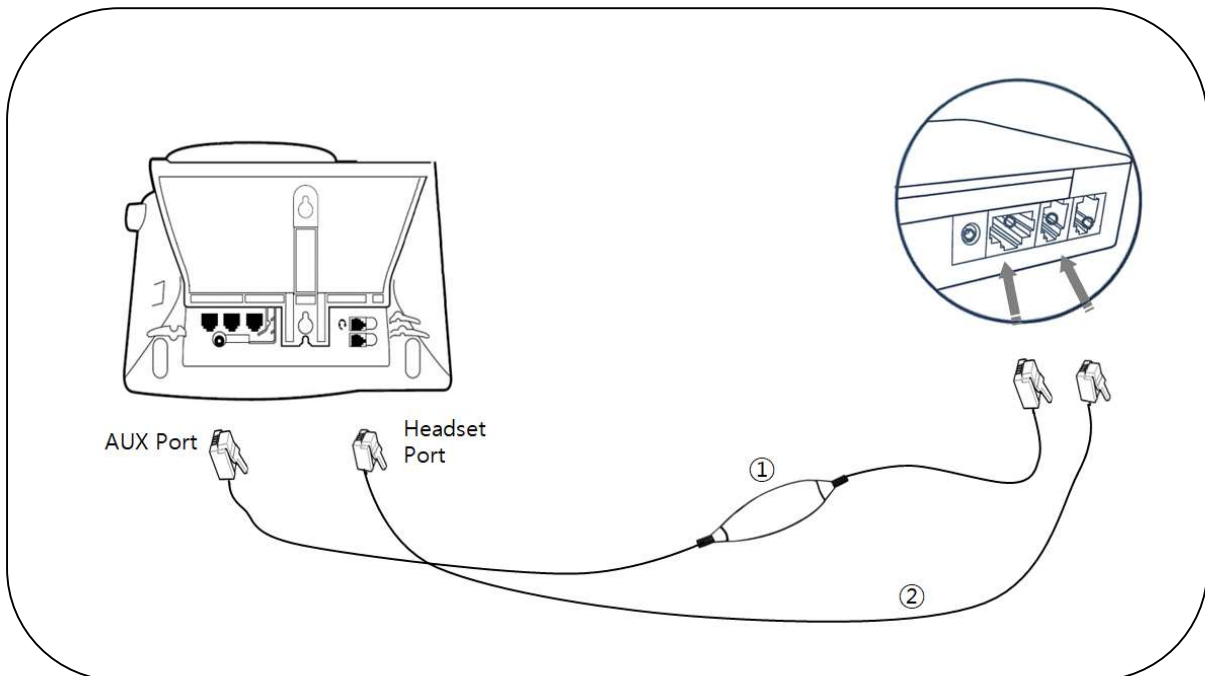

- ① EHS Adapter (EHS-2) : RJ-45 to RJ-12
- ② Telephone cord (RJ-9 to RJ-9) Cable length : 600mm

Note : Make sure that Electronic Hook switch should be enabled in Cisco Unified Communications Manager Administration.

Position of Telephone compatibility Switch : Set to '2'

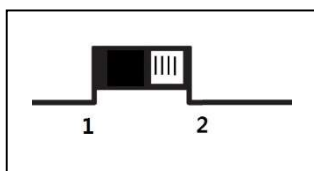



Connection Diagram

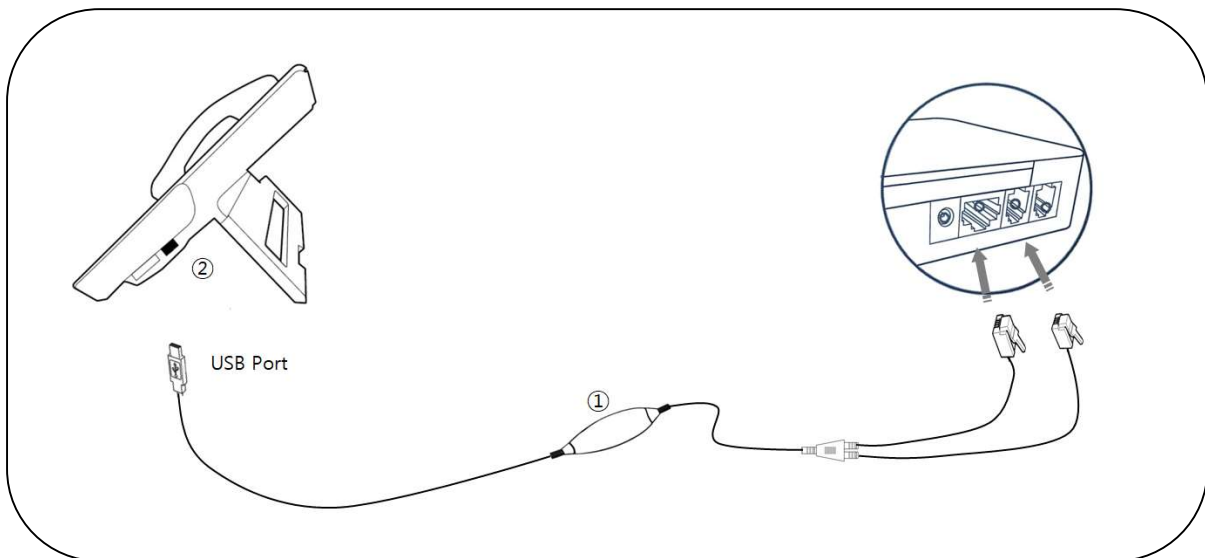

- ① : EHS Adapter (EHS-12) : RJ-45(8P8C) and RJ-9(4P4C) to USB A-type Plug
- ② : USB Port(A-type Female)

Position of Telephone compatibility Switch : Set to '1'

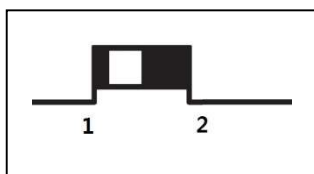



Connection Diagram

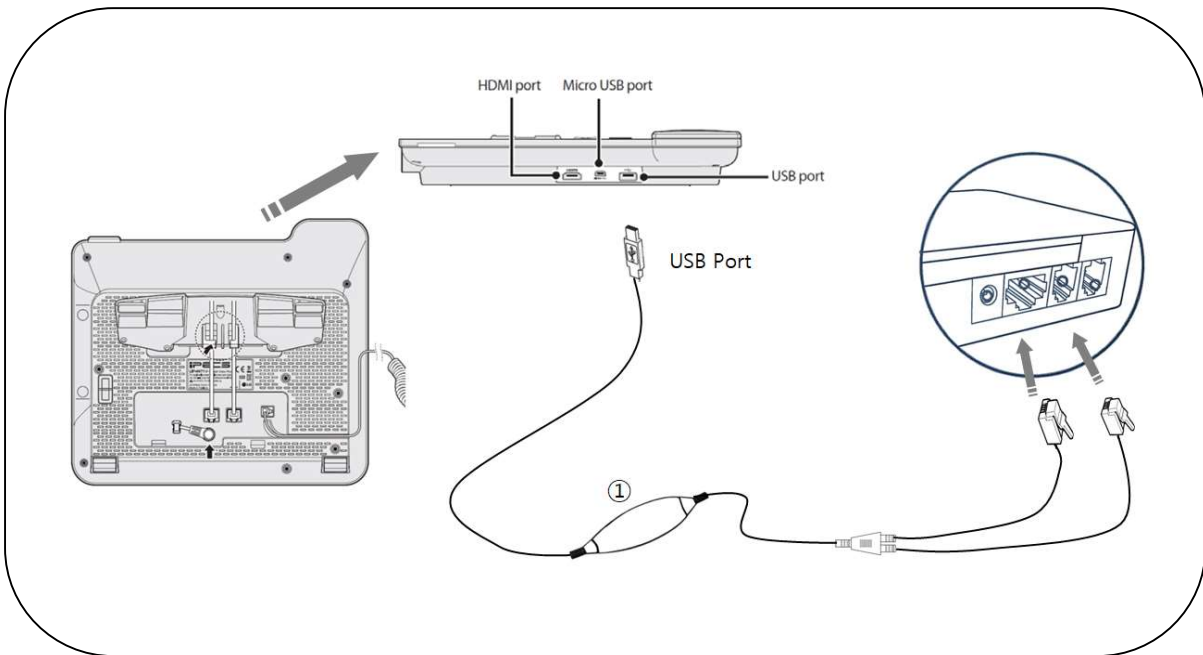

① EHS Adapter (EHS-22) : USB (A-type) to RJ-45(8P8C) and RJ-9(4P4C)

Position of Telephone compatibility Switch : Set to '1'

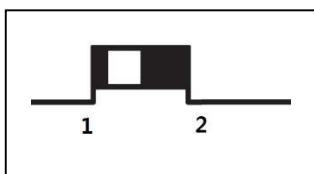

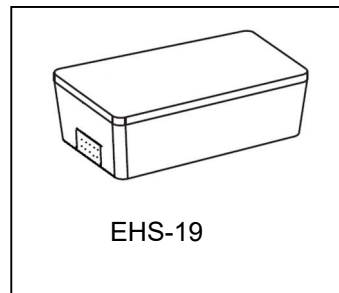

Connection Diagram

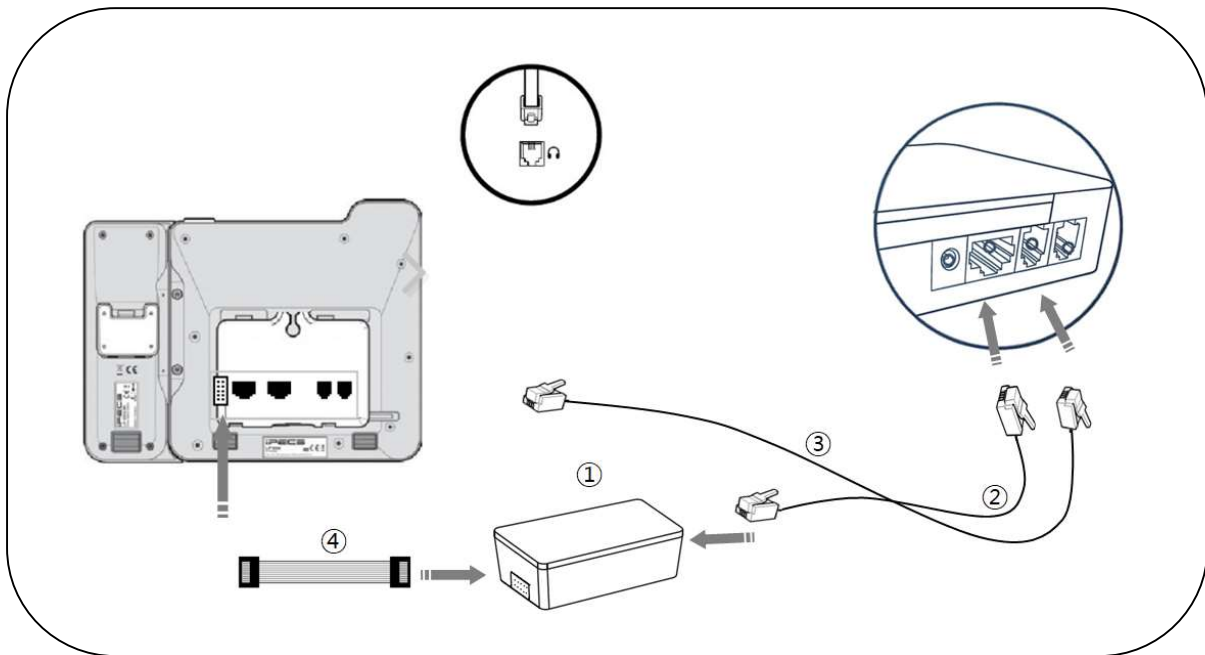

- ① EHS Adapter (EHS-19)
- ② Power cable : RJ-45(8P8C) to RJ-45(8P8C)
- ③ Telephone cord (RJ-9 to RJ-9) Cable length : 600mm
- ④ JTAG cable

Position of Telephone compatibility Switch : Set to '1'

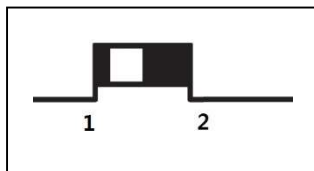

Grandstream EHS Setup guide

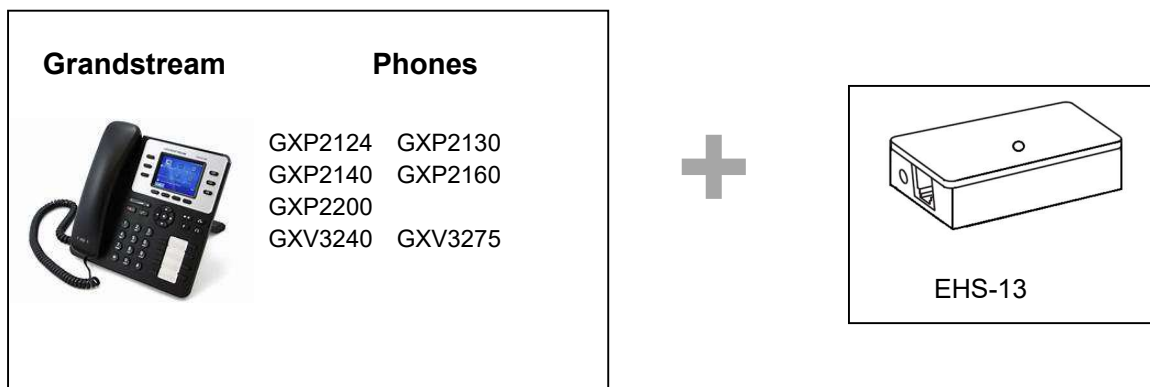

Connection Diagram

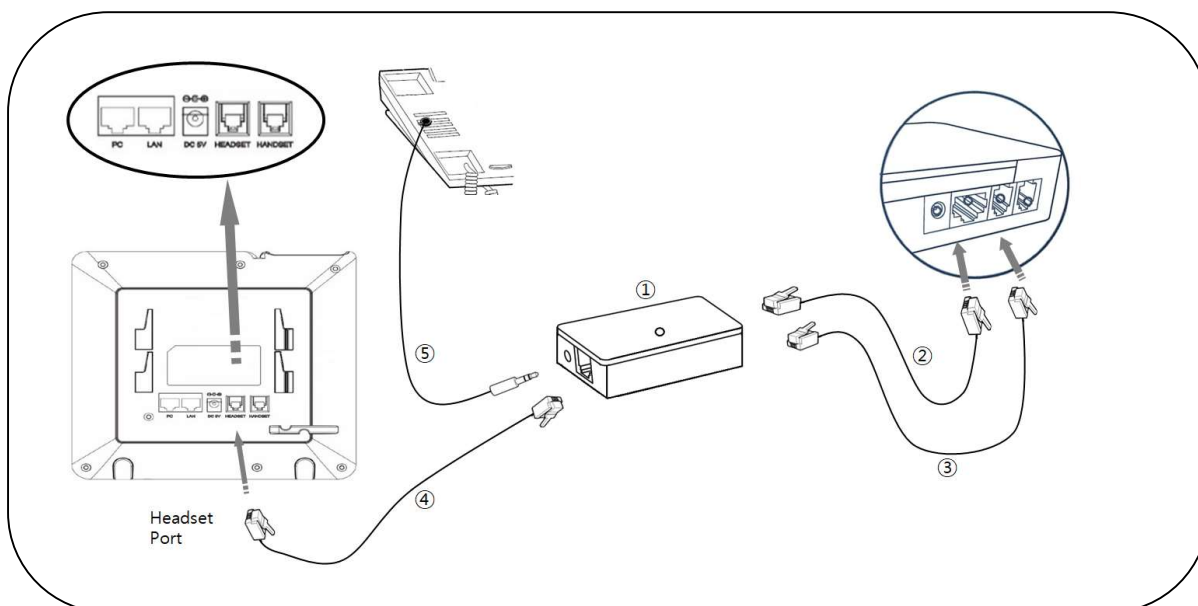

- Note : Phones require firmware 1.0.4.23 or higher
- ① EHS Adapter (EHS-13)
- ② Power cord : RJ-45 to RJ-45
- ③ Telephone cord (RJ-9 to RJ-9) : Cable length : 600mm
- ④ Telephone cord (RJ-9 to RJ-9) : Cable length : 600mm
- ⑤ External Microphone (No need) : Not included

Position of Telephone compatibility Switch : Set to '1'

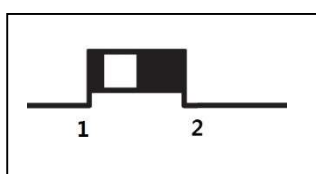

HTEK EHS Setup guide

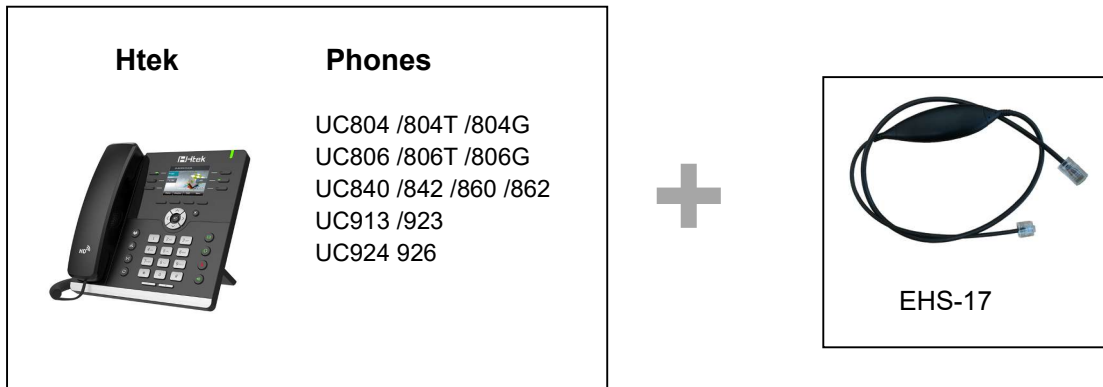

Connection Diagram

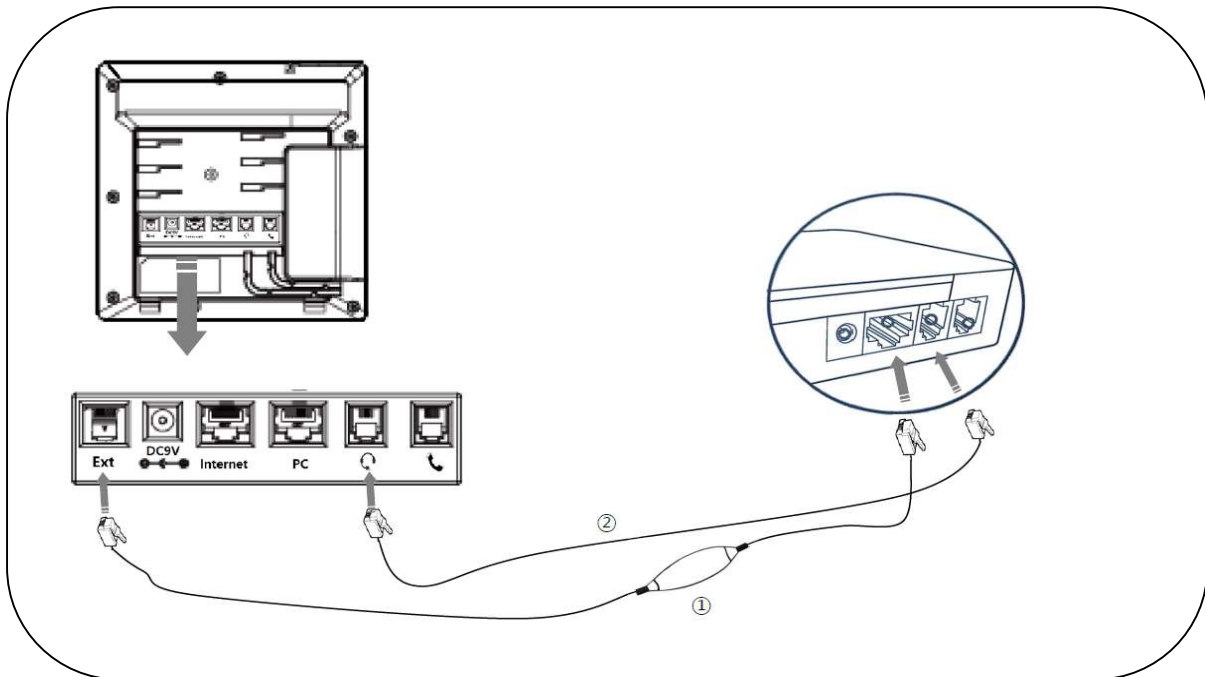

- ① : EHS Adapter (EHS-17) : RJ-45 to RJ-12
- ② : Telephone cord (RJ-9 to RJ-9) Cable length : 600mm

Position of Telephone compatibility Switch : Set to '1'

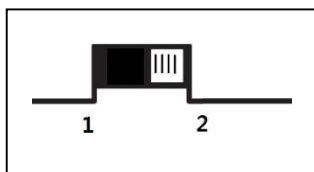

NEC EHS Setup guide

NEC	Phones
	(DT330 Series) DTL-12D-1 / DTL-24D-1 / DTL-8LD-1
	(DT430 Series) DTZ-12D-1 / DTZ-24D-1 / DTZ-8LD-1
	(DT730 Series) ITL-12D-1 / ITL-12DG-1 / ITL-12CG-1 ITL-24D-1
	(DT830 Series) ITZ-12D-1 / ITZ-24D-1 / ITZ-8LD-1
	(DT830G Series) ITZ-12DG-1 / ITZ-24DG-1 / ITZ-8LDG-1



Connection Diagram

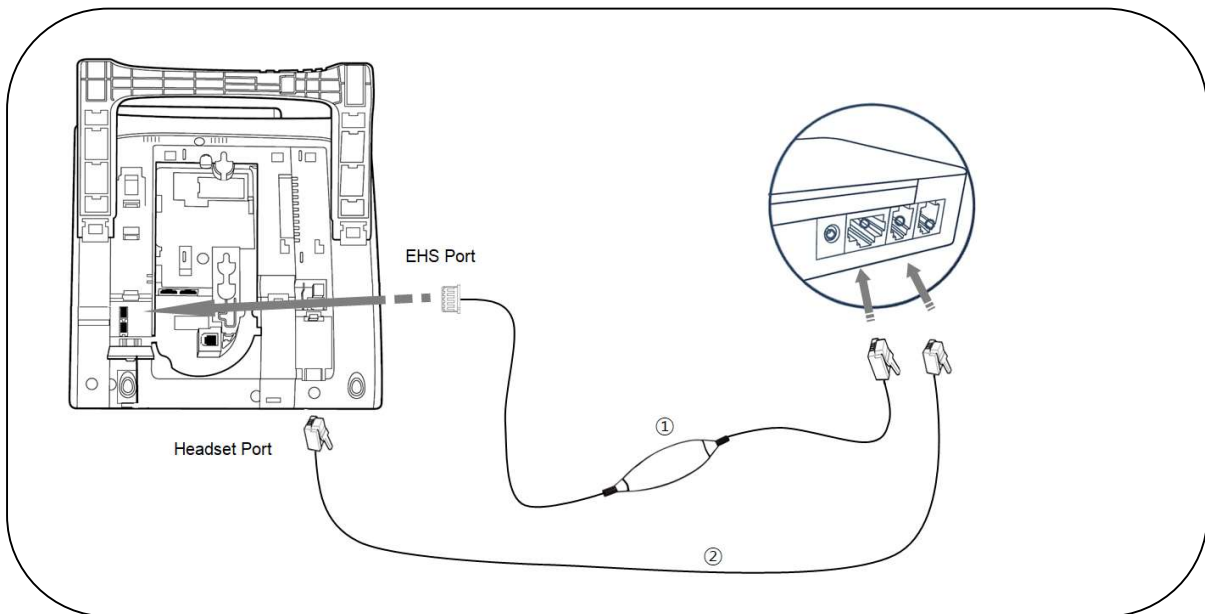

- ① EHS Adapter(EHS-27) : RJ-45 to Double Row Socket (2 x 5)
- ② Telephone cord (RJ-9 to RJ-9) : Cable length 600mm

Position of Telephone compatibility Switch : Set to '1'

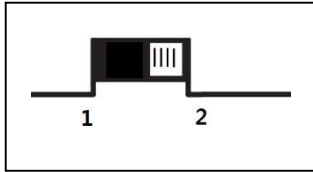

Enabling Headset on NEC phones

1. Press "Menu"
2. Select 4 AdminSettings>Maintenance
>Connector Mode>select Jabra Headset kit, press OK >press Exit > press Yes restart phone.
3. Press "Menu" > select 3 User Settings>Headset>select 1 Enable > press OK to save setting.
4. Press "Menu" > select 3 User Settings>select ringing. Choose which ringing you require 1. Phone, 2. Headset, 3. Phone and Headset > press OK to save setting.
5. Connect EHS Adapter to the side 2. Port on the back of the phone.

Panasonic EHS setup guide

Panasonic **Phones**
NT553 NT556
DT543 DT546
HDV230



EHS-1

Panasonic **Phones**
NT543



EHS-14

Connection Diagram

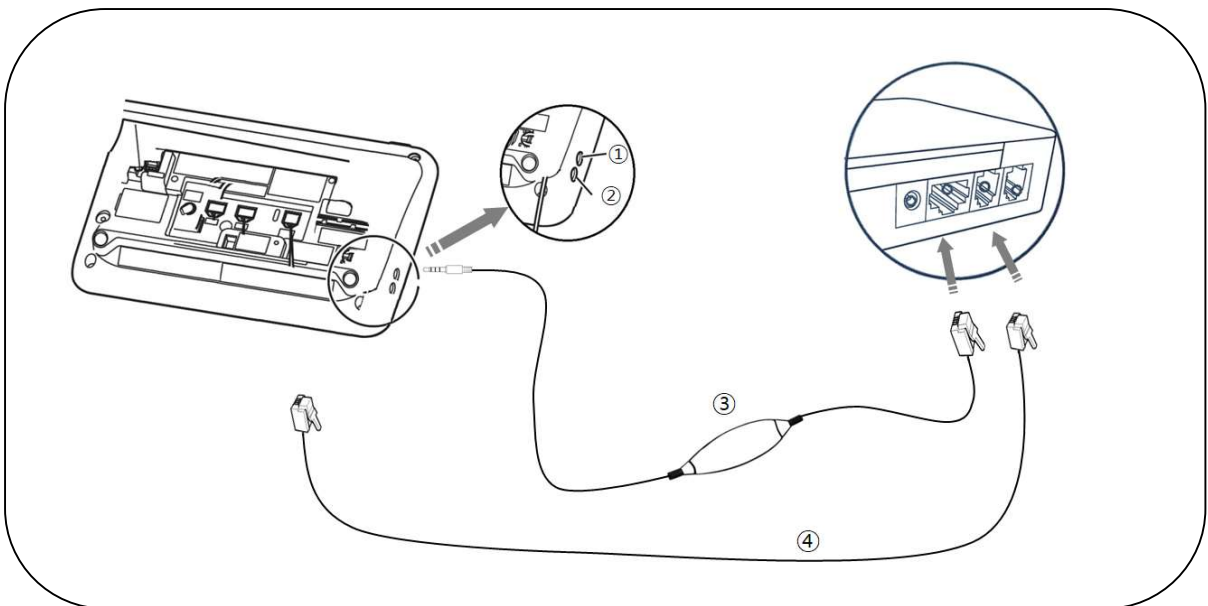

- ① Panasonic EHS Adapter : RJ-45(8P8C) to 3.5Ø Plug (4 poles for EHS-1, 3 poles for EHS-14)
- ② Headset Port (Do not use this port with EHS Adapter at the same)
- ③ EHS Port
- ④ Audio cable : RJ-9(4P4C) to RJ-9(4P4C) : To Handset port

Note : Default Audio cable is RJ-9(4P4C) to RJ-9(4P4C).

The phone doesn't support both the EHS and 2.5mm headset at the same.

To use the EHS with wireless headset you must disconnect the handset from the phone, plug a RJ-9 cable from the phone to the base unit and the plug the headset into the base unit.

Position of Telephone compatibility Switch : Set to '1'

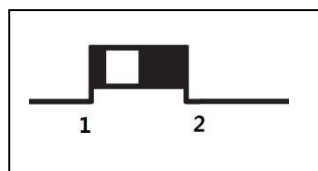

Polycom EHS Setup guide

Polycom	Phones
	IP 320 IP 321
	IP 330 IP 331
	IP 335 IP 435
	IP 450 IP 550
	IP 560 IP 650
	IP 670
	VVX 300 VVX 310
	VVX 400 VVX 410
	VVX 500 VVX 600
	VVX 1500



Connection Diagram for IP320/321/330/331

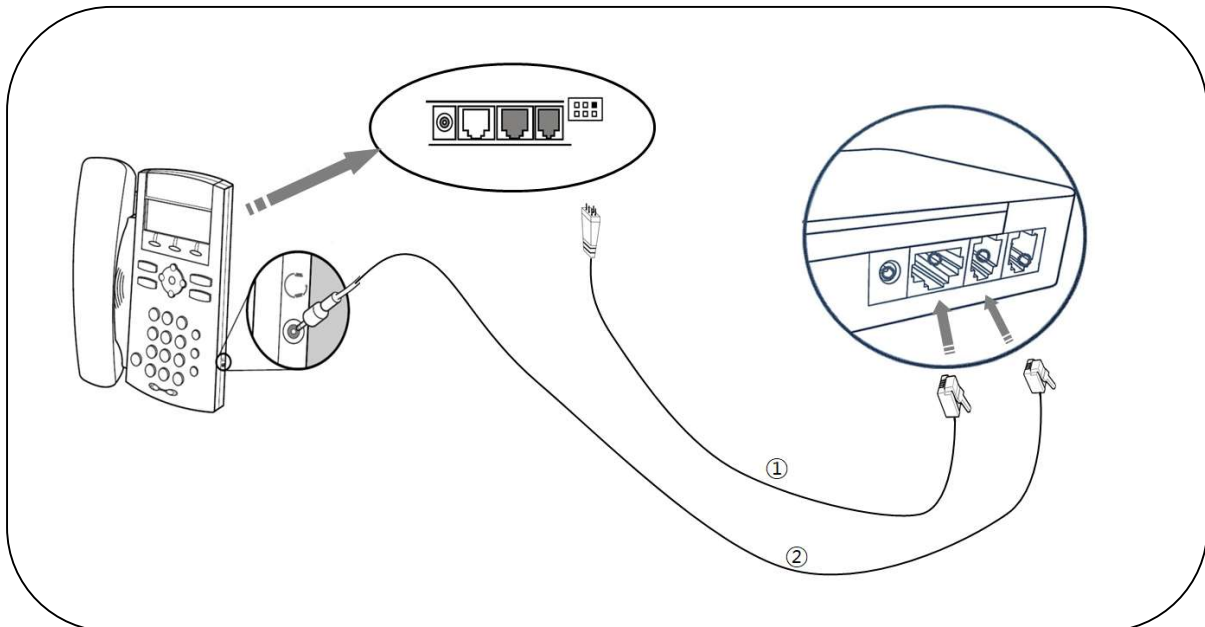

- ① Polycom EHS Adapter (EHS-5) : RJ-45(8P8c) to 5-Pin Plug
- ② Audio cables : RJ-9(4P4C) to 2.5mm Plug (3 poles)
- ③ Headset Port
- ④ EHS Port

Position of Telephone compatibility Switch : Set to '1'

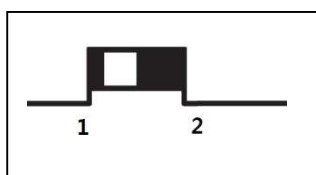

Connection Diagram for VVX series

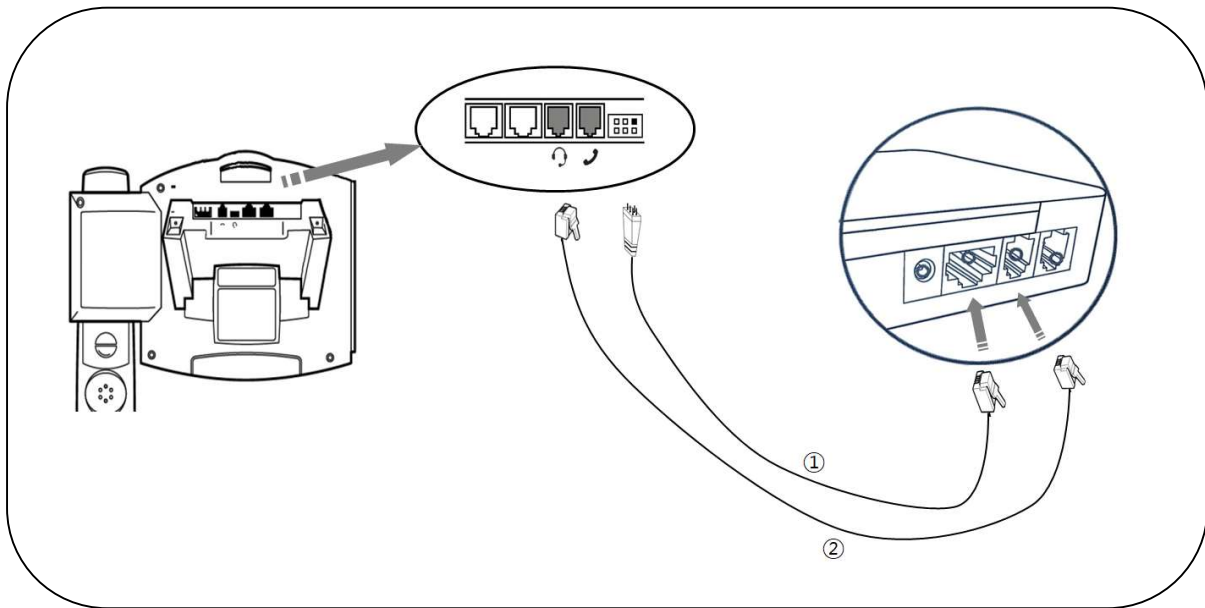

- ① Polycom EHS Adapter (EHS-5) : RJ-45(8P8c) to 5-Pin Plug
- ② Audio cables : RJ-9(4P4C) to RJ-9(4P4C)
- ③ EHS Port

Note 1: Phone must be running SIP application 3.1 or higher and BootROM 4.1.0 or later.

Note 2: Phone must be running SIP application 3.0.2 or higher and BootROM 4.1.0 or later.

Note 3: Phone must be running SIP application 3.1.0 Rev C or higher and BootROM 4.1.0 or later.

Note 4: 2.5mm headset port connector requires Audio cable for IP 320/321/330/331 models

Instruction

Access your Polycom phone menu and change the headset settings to "Jabra Mode" or "Jabra DHSG" based on the manufacturer's instructions for your specific model. Depending on your phone model, you may need to complete this step after connecting the EHS adapter. Typically, changing the settings requires that you access the "Basic," "Preferences," and "Headset" sections in the menu on your phone. Once "Analog Headset Mode" appears on the screen, use the up and down arrows to select the Jabra Mode and then choose "Back," "Exit" or "Menu" to return to the main screen.

Position of Telephone compatibility Switch : Set to '1'

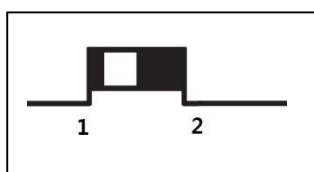

ShoreTel EHS Setup guide

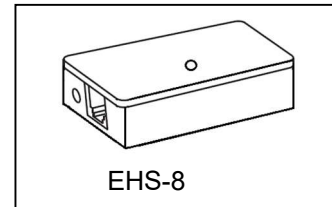

Connection Diagram

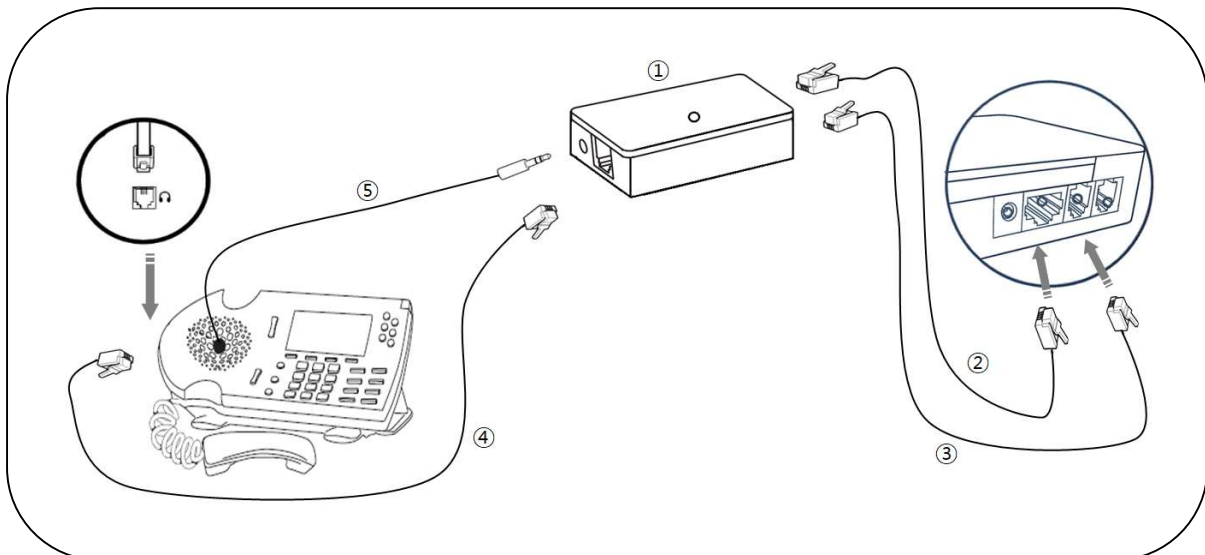

- ① EHS Adapter(EHS-8)
- ② Power cable (RJ-45 to RJ-45)
- ③ Telephone cord (RJ-9 to RJ-9) : Cable length : 600mm
- ④ Telephone cord (RJ-9 to RJ-9) : Cable length : 600mm
- ⑤ External Microphone : For ring detection

Siemens/Unify EHS Setup guide

Siemens	Phones
	OpenStage 30/40/60/80 OptiPoint 600 OptiPoint Base/Adv/Eco OptiPoint 410/420 Std/Adv



Connection Diagram

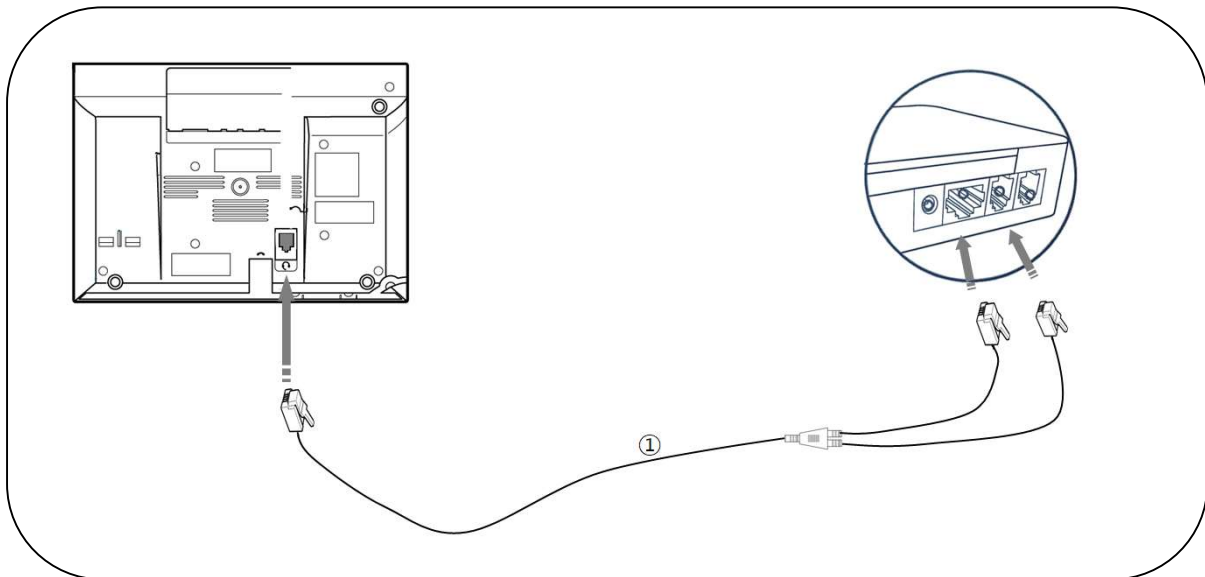

① EHS Adapter (EHS-3) : RJ-45(8P8C) and RJ-9(4P4C) to RJ-45(8P8C)

Position of Telephone compatibility Switch : Set to '1'

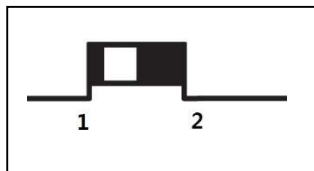

SNOM EHS Setup guide

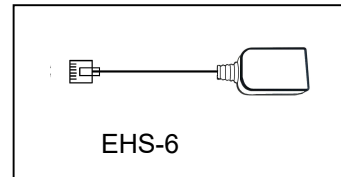

Connection Diagram

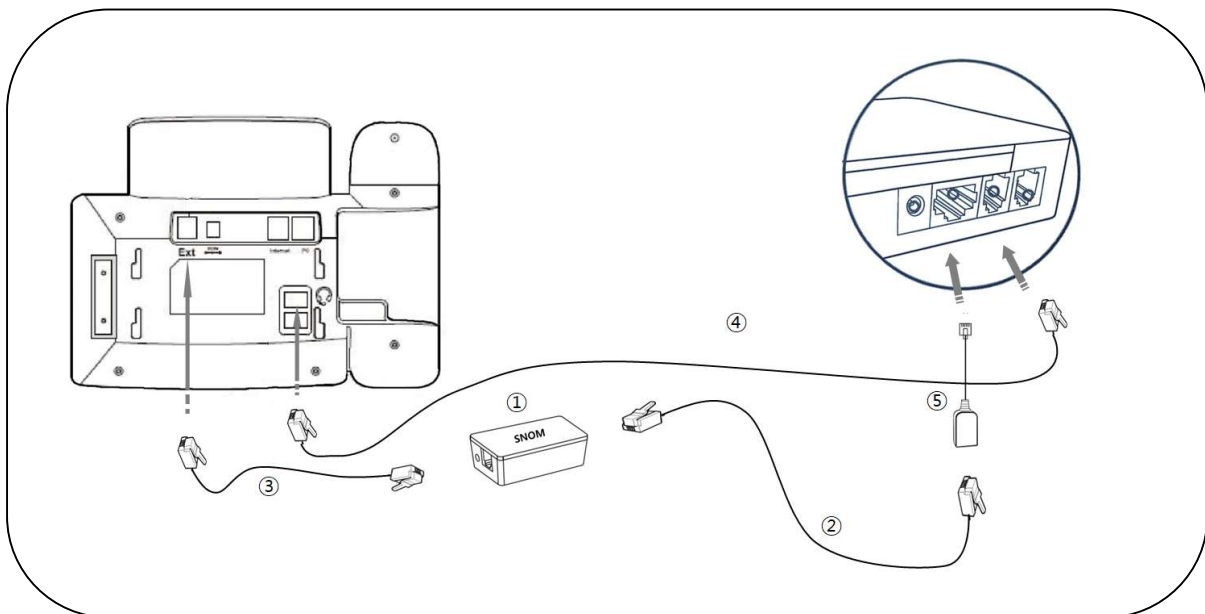

- ① EHS Adapter(SNOM) : available from Snom reseller
- ② Cord : available from Snom reseller
- ③ Cord : available from Snom reseller
- ④ Cord : available from Snom reseller
- ⑤ EHS Gender(EHS-6)

Position of Telephone compatibility Switch : Set to '1'

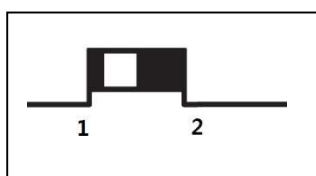

SNOM EHS Setup guide



Connection Diagram

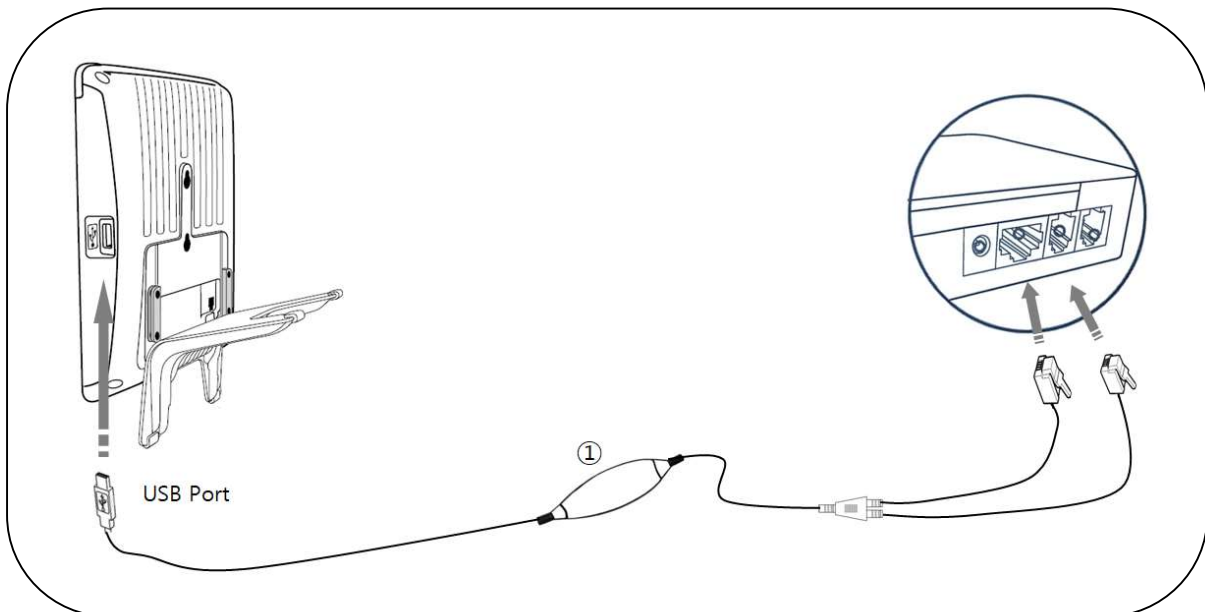

① EHS Adapter(EHS-23) : USB A-type to RJ-45 and RJ-9

Position of Telephone compatibility Switch : Set to '1'

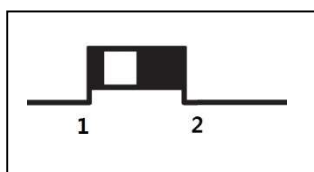



Connection Diagram

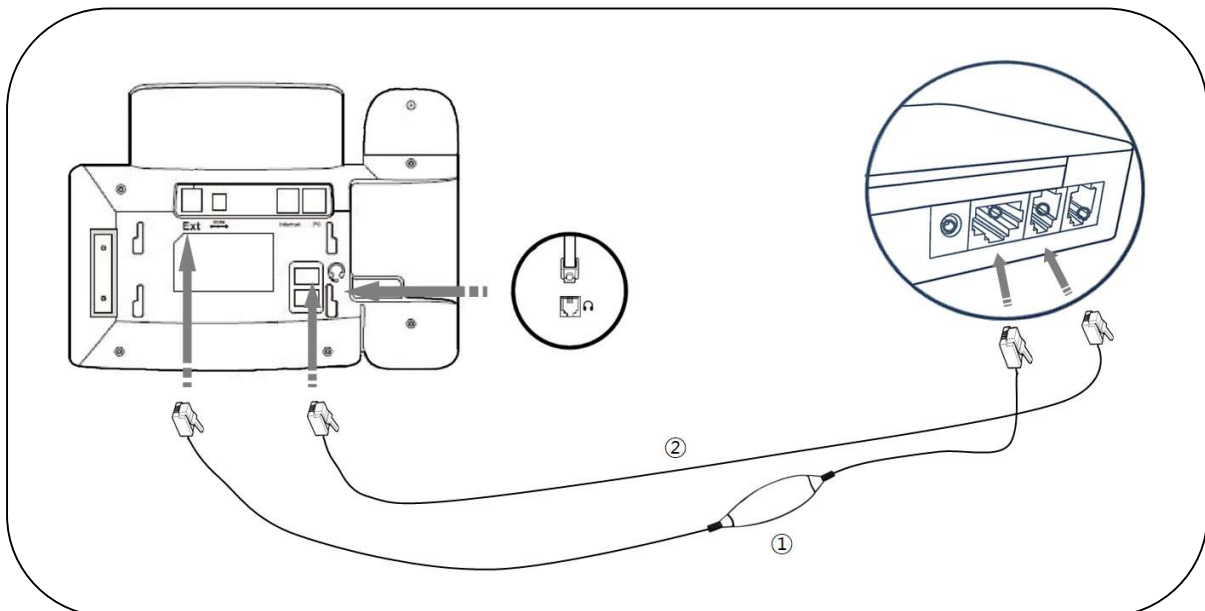

- ③ EHS Adapter(EHS-24) : RJ-45 to RJ-12
- ④ Telephone cord (RJ-9 to RJ-9) : Cable length 600mm

Toshiba EHS Setup guide

Toshiba	Phones	
	IP5022-SD	IP5122-SD
	IP5122-SDC	IP5131-SDL
	IP5132-SD	
	DP5022-SD	DP5022-SDM
	DP5032-SD	DP5122-SD
	DP5130-FSDL	DP5130-SDL
	DP5132-SD	

+

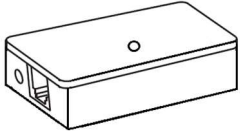

EHS-8

Connection Diagram

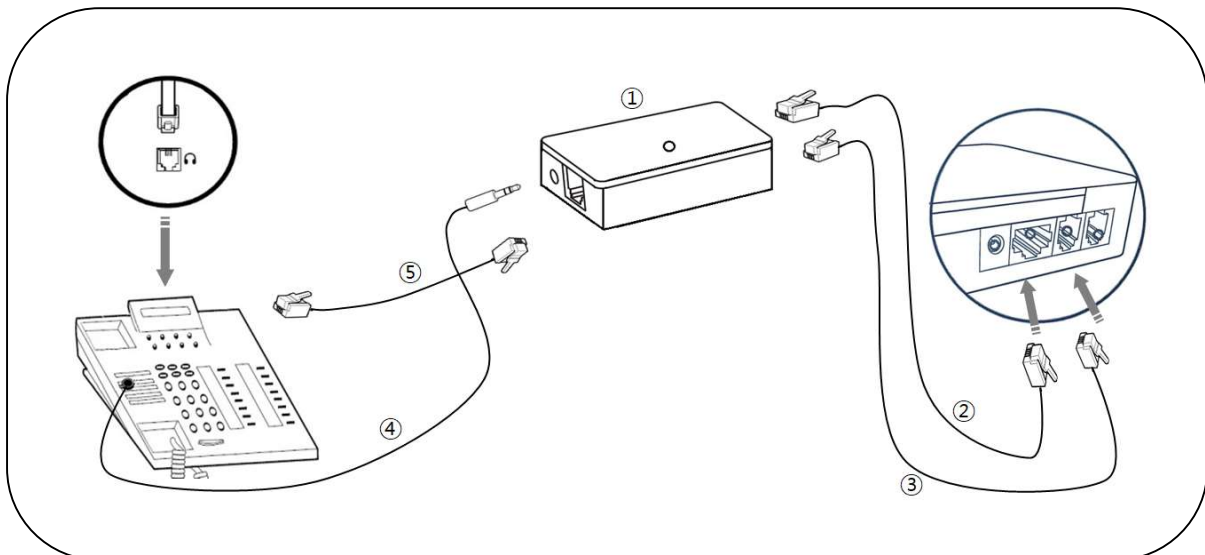

- ① EHS Adapter(EHS-8)
- ② Power cable (RJ-45 to RJ-45) : Cable length : 600mm
- ③ Telephone cord (RJ-9 to RJ-9) : Cable length : 600mm
- ④ External Microphone : For ring detection
- ⑤ Telephone cord (RJ-9 to RJ-9) : Cable length : 300mm

Position of Telephone compatibility Switch : Set to '1'

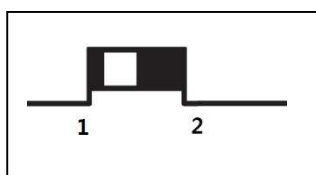

Yealink EHS Setup guide

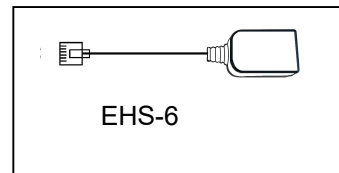

Connection Diagram

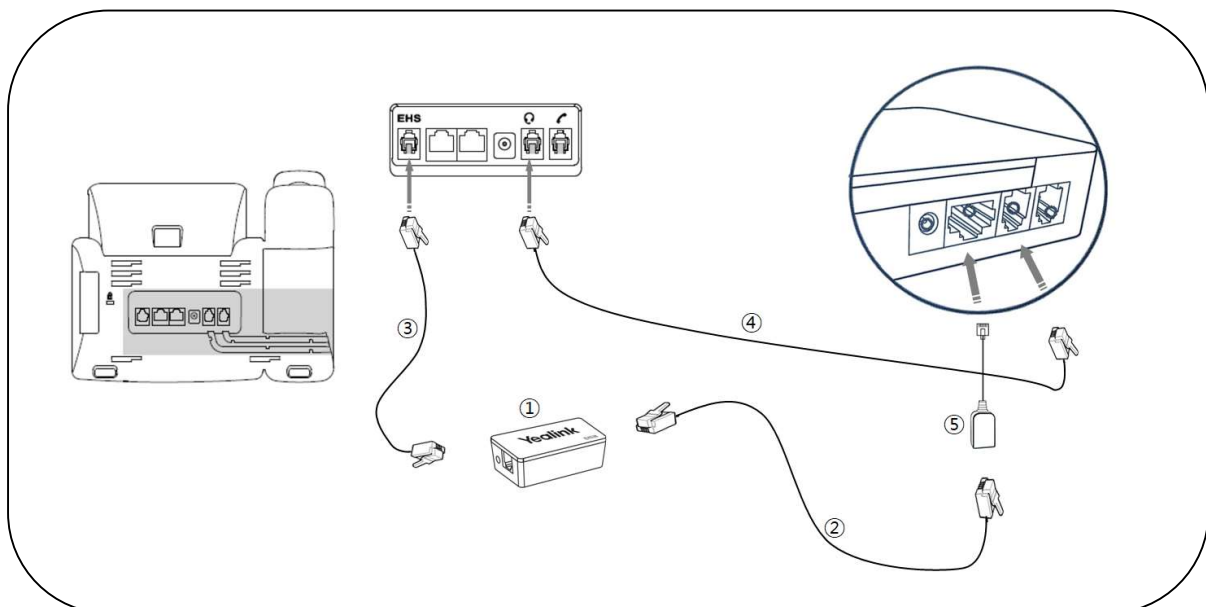

- ① EHS Adapter Yealink (EHS36) : available from Yealink reseller
- ② Cord : available from Yealink reseller
- ③ Cord : available from Yealink reseller
- ④ Cord : available from Yealink reseller
- ⑤ EHS Gender (EHS-6)



Connection Diagram

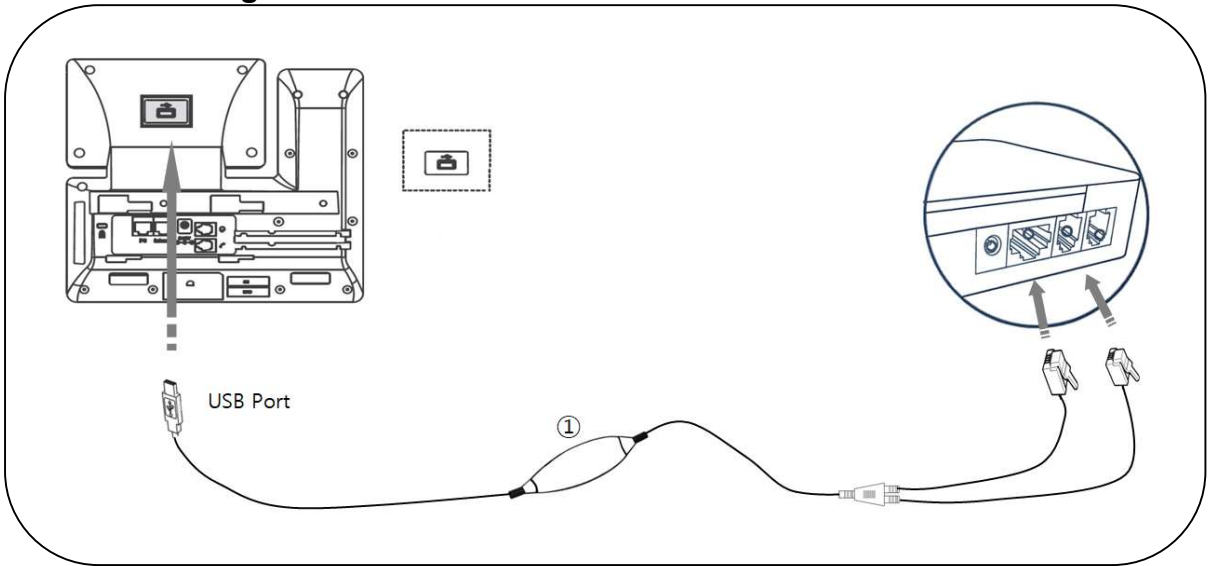

- ① : EHS Adapter (EHS-28) : RJ-45(8P8c) and RJ-9(4P4C) to USB A-type Plug
- ② : USB Port(A-type Female)

Position of Telephone compatibility Switch : Set to '1'

