

# Flux - Seating Unit

## FL-SM3



## ASSEMBLY INSTRUCTIONS

Flux  
Media Unit

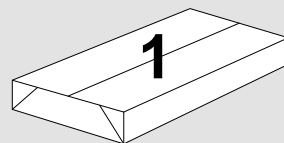

**Pack 1:**  
1x Frame  
FL\_3X5\_UO\_3X4

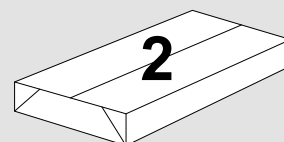

**Pack 2:**  
1x Seat Cushions  
FL-SU-4X3

TOOLS REQUIRED  
FOR ASSEMBLY

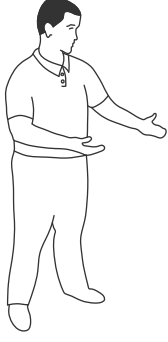

DONT STRUGGLE  
2 MAN LIFT

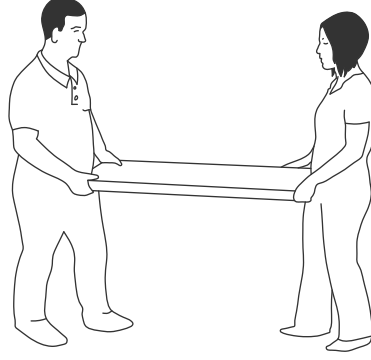
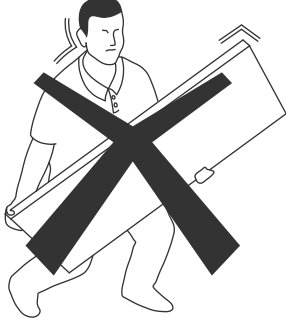

ALWAYS HANDLE  
ITEMS WITH CARE

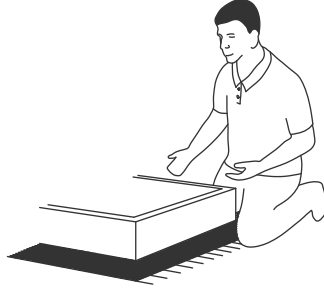
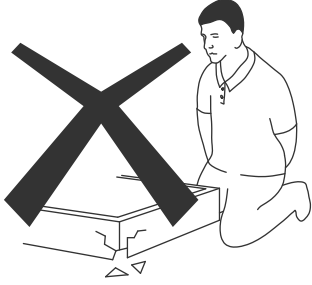

IF UNSURE CALL  
FOR ASSISTANCE

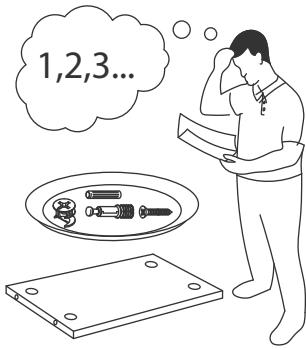

KEEP FITTINGS AWAY  
FROM CHILDREN

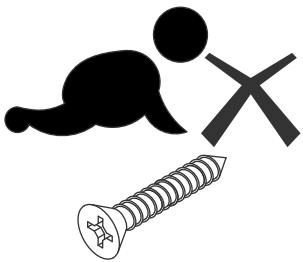



Please check that you have all the panels

FL-SU-4X3

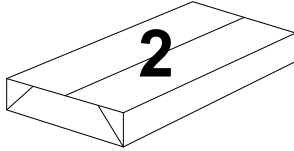

**PACK 2:**  
1 x Seating Cushions

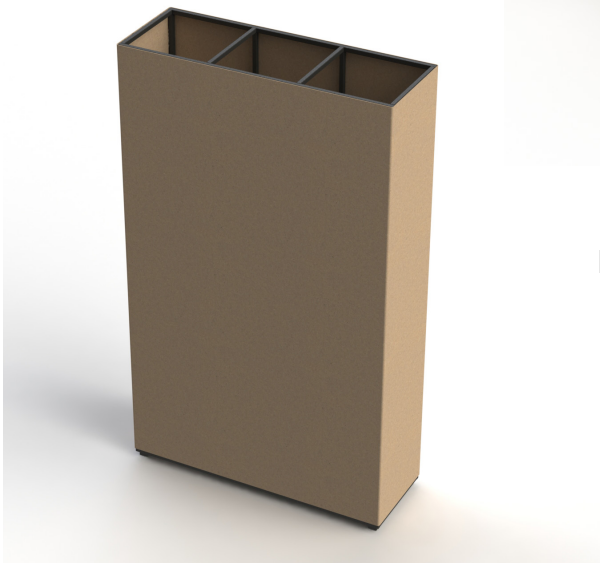
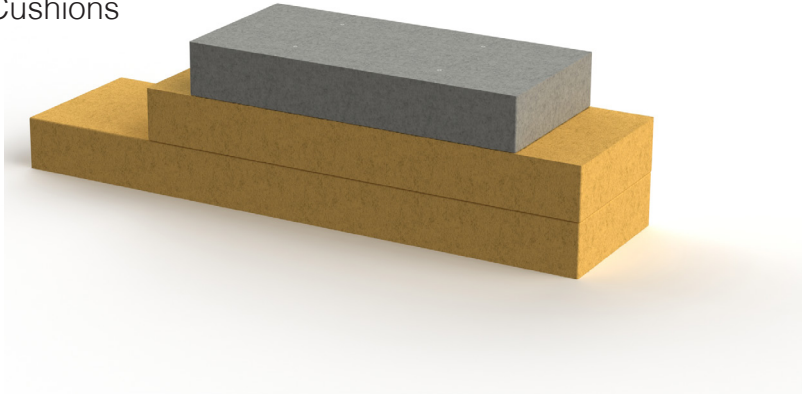

FL\_3X5\_UO\_3X4

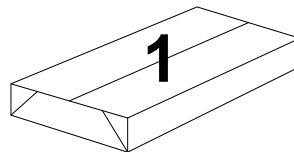

**PACK 1:**  
1 x Frame



Please check that you have all the fittings

**FITTINGS SUPPLIED**



Countersink M6 Bolt

Size  
45mm

**PCS**  
**12**

# FLUX SEATING UNIT ASSEMBLY

## 1

### Step 1

Unpack your new seating unit & frame and please recycle all packaging.

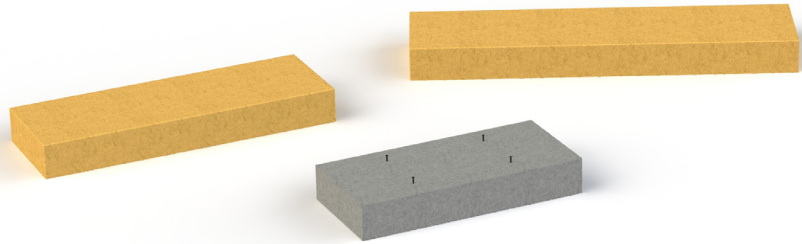

## 2

### Step 2

Ensure the frame is vertical prior to placing the media unit into position. Fix the seat base into location using the M6 bolts turning clockwise.

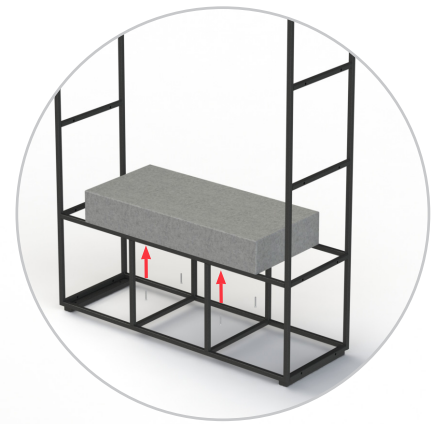
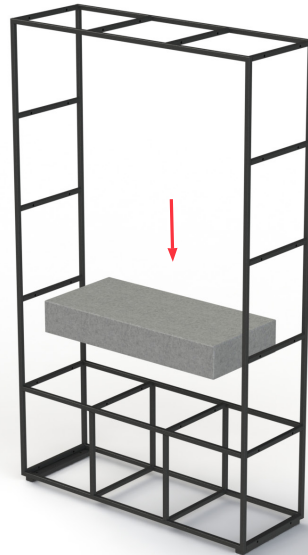
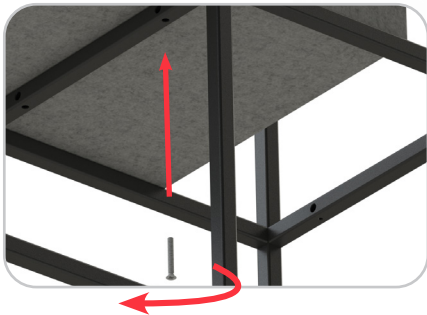

## 3

### Step 3

Fix the vertical side cushions into location using the M6 bolts as shown turning clockwise.

