









ASSEMBLY INSTRUCTIONS

Please note that all fittings are packed with chair gas lift.

- (A)  1PC
- (B)  5PCS
- (C)  1PC
- (D)  1PC
- (E)  M8X20MM 4PCS
- (F)  M8X25MM 4PCS
- (G)  M6X25MM 2PCS
- (H)  4PCS
- (I)  1PC

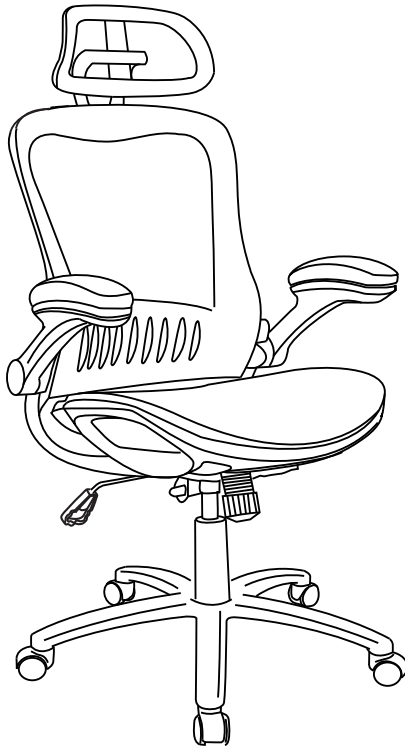

CUR300T1



Do not tighten bolts fully until you have completed assembly.
 "Should you require any assistance in assembling your goods please contact customer services on 0151 548 7111 between 9am/4:30pm.

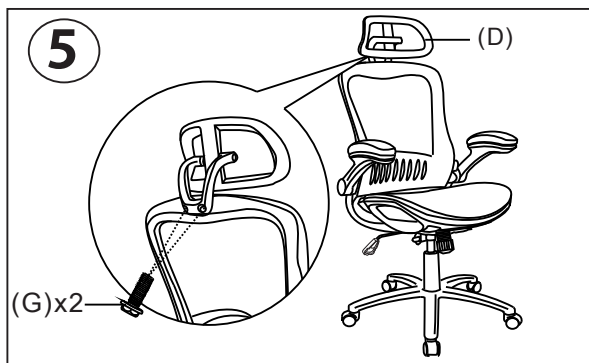
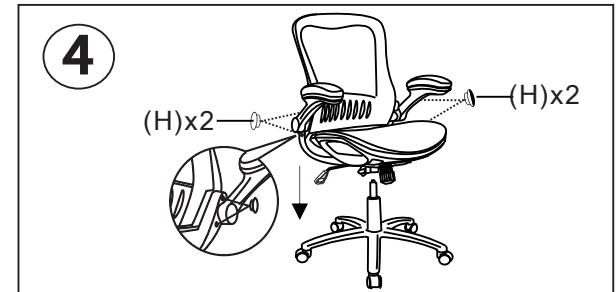
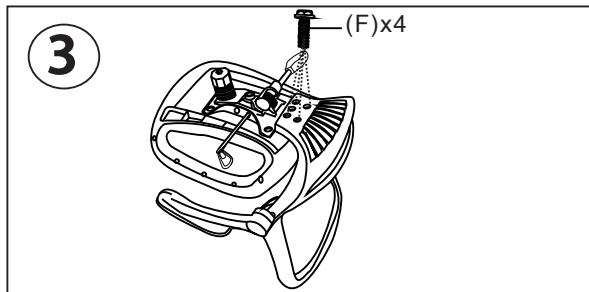
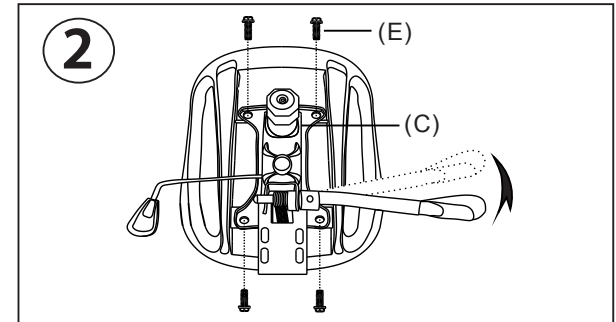
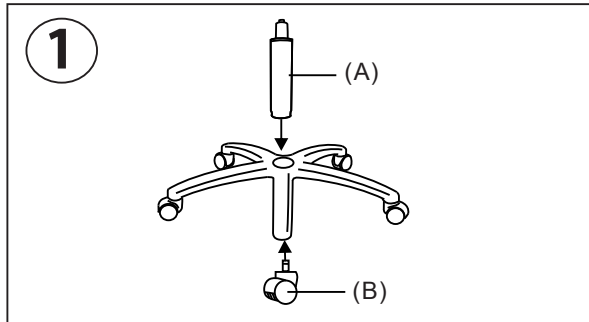

WARNING

- DO NOT USE THIS CHAIR AS A STEPLADDER
- USE THIS PRODUCT ONLY FOR SEATING ONE PERSON AT A TIME
- DO NOT USE THIS CHAIR UNLESS ALL BOLTS, SCREWS AND KNOBS ARE FIRMLY SECURED
- AT LEAST EVERY 4 MONTHS CHECK ALL BOLTS, SCREWS AND KNOBS TO BE SURE THEY REMAIN TIGHT
- IF PARTS ARE MISSING, BROKEN, DAMAGED OR WORN, STOP USING THE PRODUCT UNTIL REPAIRS ARE MADE USING AUTHORIZED PARTS
- FAILURE TO FOLLOW THESE INSTRUCTIONS/WARNINGS COULD RESULT IN SERIOUS INJURY