

Anson - Rectangular Table

ANS-TBR22



ASSEMBLY INSTRUCTIONS

Anson
Square Table

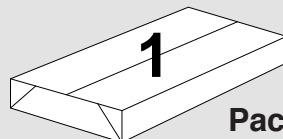

Pack 1:
Top Pack

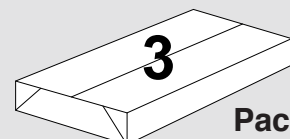

Pack 3:
Corner Kit

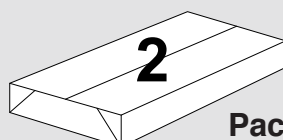

Pack 2:
Leg Kit

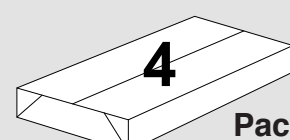

Pack 4:
Rail Kit

TOOLS REQUIRED
FOR ASSEMBLY

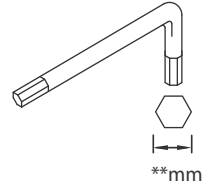
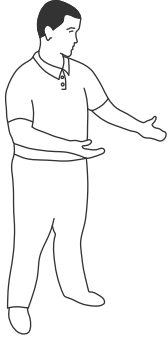

DONT STRUGGLE
2 MAN LIFT

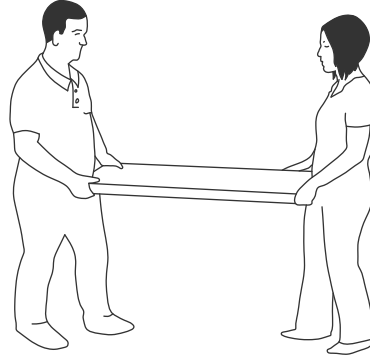
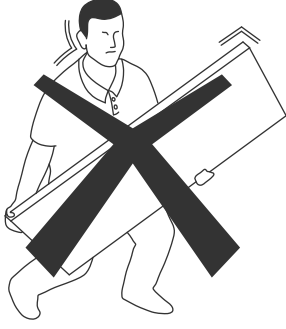

ALWAYS HANDLE
ITEMS WITH CARE

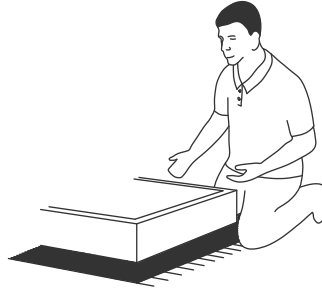
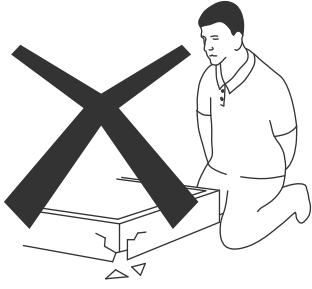

IF UNSURE CALL
FOR ASSISTANCE

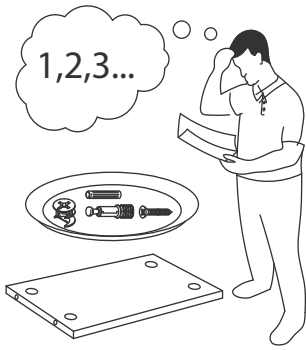

KEEP FITTINGS AWAY
FROM CHILDREN

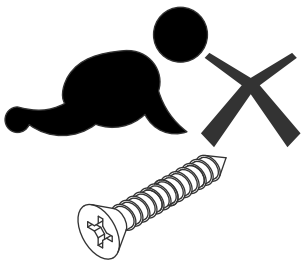



Please check that you have all the panels

ANS-TBR22-TOP

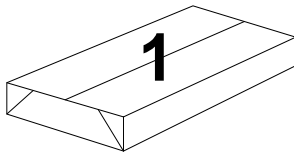

PACK 1:
1 x Top Panel

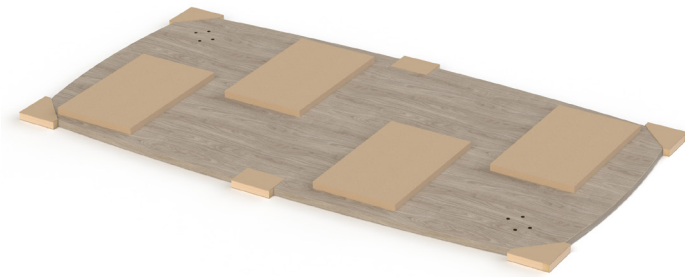

HN-LEG10-KIT

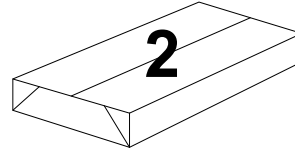

PACK 2:
2 x Leg Kit



HN-CAST

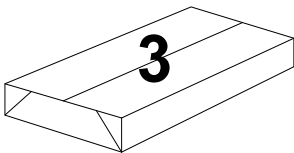

PACK 3:
1 x Corner Kit



HN-RAIL-2200

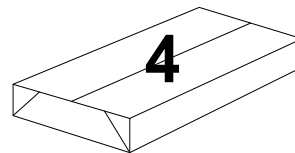

PACK 4:
1 x Rail Kit



Please check that you have all the fittings

FITTINGS SUPPLIED



M6 Connector Bolt

Size
25mm

PCS
44



Adjustable Foot

Size
25mm dia.

PCS
4

ANSON RECTANGULAR TABLE ASSEMBLY

1

Step 1

Unpack your Anson rectangular table and please recycle all packaging.

Place the top face down so that the fixing holes are face-up.

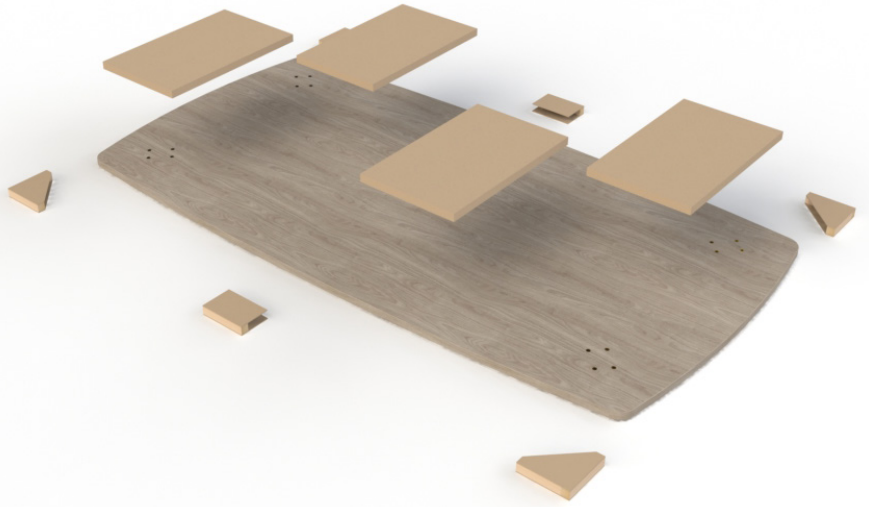

2

Step 2

Assemble the legs as per 'image a' using parts from leg kit & corner kit.

Link all the legs together attaching them with the rail kit as per 'image b'

image 'a'.

image 'b'.



3

Step 3

Once the frame is assembled place on the underside of the top and affix using the 16x M6 bolts as shown.

